



Garg



SLIDING DOOR GEAR & WARDROBE GEAR

Visit us at : www.garglocks.com

SLIDING WARDROBE GEAR



TECHNICAL DATA

ITEM CODE	ITEM	
SWG0001	Sliding Wardrobe Gear (Ares 2 Equivalent) 2 Doors	1200
SWG0002	Sliding Wardrobe Gear (Ares 2 Equivalent) 2 Doors	1500
SWG0003	Sliding Wardrobe Gear (Ares 2 Equivalent) 2 Doors	1800
SWG0004	Sliding Wardrobe Gear (Ares 2 Equivalent) 3 Doors	2000
SWG0005	Sliding Wardrobe Gear (Ares 2 Equivalent) 3 Doors	2400
SWG0006	Sliding Wardrobe Gear (Ares 2 Equivalent) 3 Doors	3000

FEATURES:-

- Aluminium top channels with nylon guides
- Aluminium bottom rails with nylon rollers
- Quiet, smooth operation
- Multiple tracks can be fitted
- Two door kit
- Kit contains: 2 lengths of bottom track, 2 lengths of top channel, 4 bottom rollers, 4 nylon top guides, door stop

DOUBLE WARDROBE TOP SLIDING DOOR SYSTEM

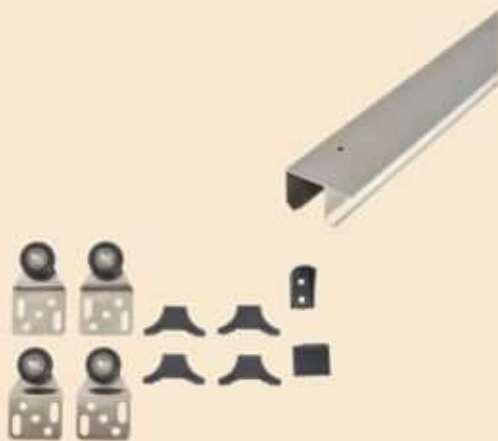

TECHNICAL DATA

ITEM CODE	ITEM	
SWG0051	DOUBLE WARDROBE TOP SLIDING DOOR SYSTEM	1500MM
SWG0052	DOUBLE WARDROBE TOP SLIDING DOOR SYSTEM	2000MM
SWG0053	DOUBLE WARDROBE TOP SLIDING DOOR SYSTEM	3000MM

FEATURES:-

- For double leaf, wood or composite sliding doors
- Easy stop & fixings top track & floor guides
- Kit contain :6 hangers 4 bottom guides, door stop & all necessary fixings for 2 doors



DOUBLE WARDROBE TOP SLIDING DOOR SYSTEM 45KG

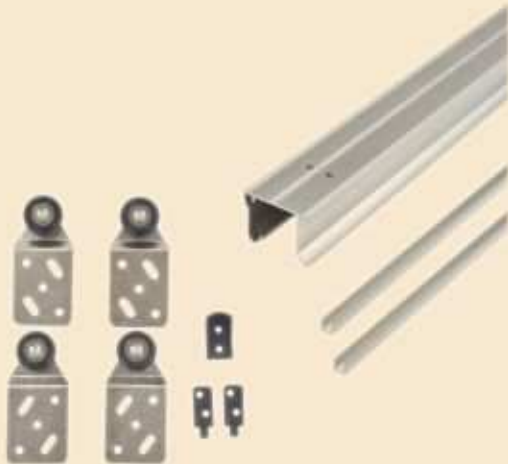

TECHNICAL DATA

ITEM CODE	ITEM	
SWG0061	DOUBLE WARDROBE TOP SLIDING DOOR SYSTEM	2000MM
SWG0062	DOUBLE WARDROBE TOP SLIDING DOOR SYSTEM	3000MM

FEATURES:-

- For double leaf, wood or composite sliding doors
- Suitable for door thickness 16 - 40mm
- Easy soffit fixing top track & bottom channels
- Fitting pack contains: 4hangers, door stop & all necessary fixings
- order tracks & fitting packs separately

WARDROBE SLIDING DOOR GEAR



TECHNICAL DATA

ITEM CODE	ITEM	
SWG0100	SLIDING WARDROBE GEAR	1200MM
SWG0101	SLIDING WARDROBE GEAR	1800MM

FEATURES:-

- Aluminium top channels with nylon guides
- Aluminium bottom rails with nylon rollers
- Quiet, smooth operation
- Multiple tracks can be fitted
- Two door kit
- Kit contains: 2 lengths of bottom track, 2 lengths of top channel, 4 bottom rollers, 4 nylon top guides, door stop

MULTIFOLD SLIDING DOOR SYSTEM KITS

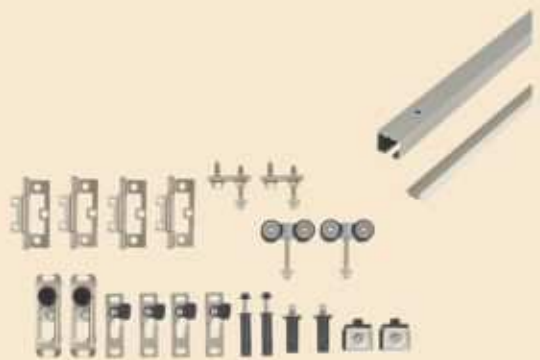

TECHNICAL DATA

ITEM CODE	ITEM
SWG0071	MULTIFOLD SLIDING DOOR SYSTEM KIT 2000MM TRACK 2 DOOR 1 WAY
SWG0072	MULTIFOLD SLIDING DOOR SYSTEM KIT 2000MM TRACK 4 DOOR 2 WAY
SWG0073	MULTIFOLD SLIDING DOOR SYSTEM KIT 3000MM TRACK 2 DOOR 1 WAY
SWG0074	MULTIFOLD SLIDING DOOR SYSTEM KIT 3000MM TRACK 4 DOOR 2 WAY

FEATURES:-

- A high quality folding, top hung kit ideal for wardrobes, closet doors, kitchen cupboards and many other uses
- Just buy one track with the relevant fitting pack for everything you need to install 2 door or 4 door
- Easy soffit fixing top track & bottom channels
- Tracks & fitting packs must be ordered separately

BI-FOLD SLIDING DOOR SYSTEM KITS

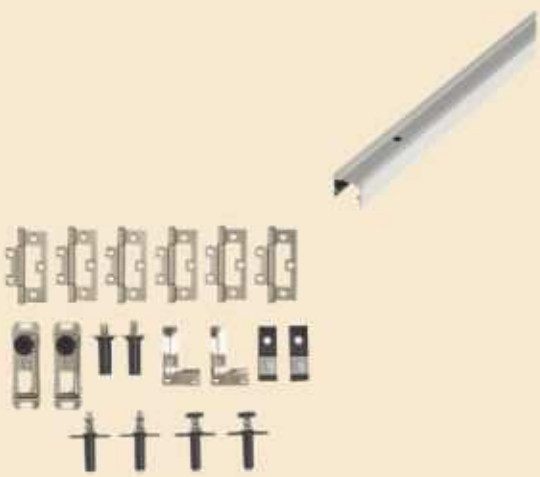

TECHNICAL DATA

ITEM CODE	ITEM
SWG0081	BI FOLD SLIDING DOOR SYSTEM KIT 14KG- 1.2M TRACK 2 DOORS 1 WAY
SWG0082	BI FOLD SLIDING DOOR SYSTEM KIT 14KG- 1.2M TRACK 4 DOORS 2 WAY
SWG0083	BI FOLD SLIDING DOOR SYSTEM KIT 14KG- 1.6M TRACK 2 DOORS 1 WAY
SWG0084	BI FOLD SLIDING DOOR SYSTEM KIT 14KG- 1.6M TRACK 4 DOORS 2 WAY

FEATURES:-

- For wood or composite folding doors
- Nylon spring loaded guides in an aluminium top track
- Leaves fold completely flat for easy access
- Any number of two leaf units can be used for an opening, each anchored by top & bottom pivots
- Fitting pack contains top & bottom pivots, hinges & top guide
- Order tracks & fitting packs separately

SLIDING DOOR GEAR

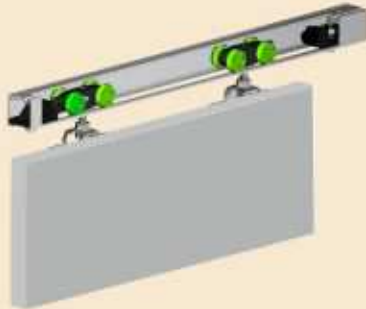

TECHNICAL DATA

ITEM CODE	ITEM	
SDG0001	Sliding Door Gear (Herkulose 60 Equivalent) 1 Doors	1200
SDG0002	Sliding Door Gear (Herkulose 60 Equivalent) 1 Doors	1500
SDG0003	Sliding Door Gear (Herkulose 60 Equivalent) 1 Doors	1800
SDG0004	Sliding Door Gear (Herkulose 60 Equivalent) 1 Doors	2000
SDG0005	Sliding Door Gear (Herkulose 60 Equivalent) 1 Doors	2400
SDG0006	Sliding Door Gear (Herkulose 60 Equivalent) 1 Doors	3000

FEATURES:-

- Gear only does not include glass door & handles
- Suitable for 8-12mm glass door
- Soft open & close
- Smooth sliding motion
- Countersunk glass fixings
- Easy to install

BI PASSING SLIDING SYSTEM

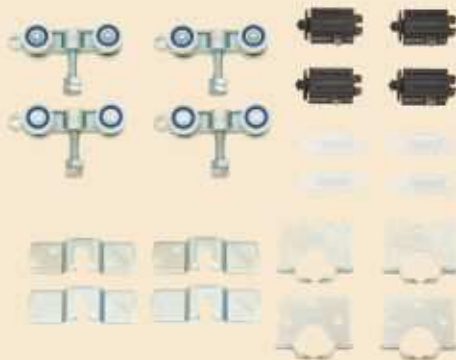

TECHNICAL DATA

ITEM CODE	ITEM
SDG0300	3DOOR SLIDING DOOR PACK

FEATURES:-

- Ideal for heavy bi-passing room dividers, wardrobe & cupboard doors
- Ball bearing system with nylon wheels, enabling a smooth and quiet operation
- Fitting pack Includes nylon wheel hangers with both top and side fix plate options-suit 2 door or 3 door applications
- Track and channel kit must be ordered separately, supplied in a satin anodised aluminium finish & can be cut to size
- Optional soft close available fit one per door

BARN TYPE SLIDING DOOR

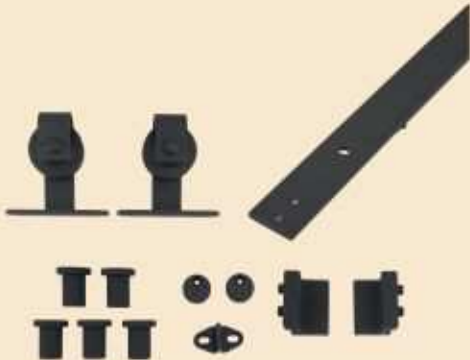

TECHNICAL DATA

ITEM CODE	ITEM	
SBG0001	BARN STRAP SLIDING DOOR KIT EQUIVALENT TO BARRIERSLIDE IVAN 2.0 80 KG	1000x2400
SBG0002	BARN STRAP SLIDING DOOR KIT EQUIVALENT TO BARRIERSLIDE IVAN 2.0 80 KG	1000x2400

FEATURES:-

- Smooth sliding motion
- 200mm flat bar track
- Can be used with doors up to 150kg without the softclosers, with the softclosers maximum weight 80kg
- Easy to install
- Tracks to make a double door & bi-passing kit allows two tracks to be mounted in front of each other

BARN STRAP SLIDING DOOR GEAR



TECHNICAL DATA

ITEM CODE	ITEM	
SBG0010	BARN STRAP SLIDING DOOR GEAR	1026x2040

FEATURES:-

- Rustic traditional barn style in a modern finish
- Smooth sliding motion
- Flat bar track
- Max door Size: 1026 x 2040mm
- For door 35-44 mm tick
- Can be used with door up to 100kg
Optional soft close-ideal for doors up to 60kg
- Easy to install
- Contents: 1 x 2000mm track, 2 x hangers, 5 x track wall spacers, 2 x anti-jump devices, 2 x door stops, 1 x door guide, with bolts & fixings

BI FOLD SLIDING DOOR GEAR SYSTEM



TECHNICAL DATA

ITEM CODE	ITEM
BDG0001	BIFOLD DOOR GEAR EQUIVALENT OF BARRIERFOLD SLIDING DOOR SYSTEM INWARD 1 DOOR KIT
BDG0002	BIFOLD DOOR GEAR EQUIVALENT OF BARRIERFOLD SLIDING DOOR SYSTEM INWARD 2 DOOR KIT
BDG0003	BIFOLD DOOR GEAR EQUIVALENT OF BARRIERFOLD SLIDING DOOR SYSTEM INWARD 3 DOOR KIT
BDG0004	BIFOLD DOOR GEAR EQUIVALENT OF BARRIERFOLD SLIDING DOOR SYSTEM INWARD 4 DOOR KIT
BDG0005	BIFOLD DOOR GEAR EQUIVALENT OF BARRIERFOLD SLIDING DOOR SYSTEM INWARD 5 DOOR KIT
BDG0006	BIFOLD DOOR GEAR EQUIVALENT OF BARRIERFOLD SLIDING DOOR SYSTEM INWARD 2+2 DOOR KIT
BDG0007	BIFOLD DOOR GEAR EQUIVALENT OF BARRIERFOLD SLIDING DOOR SYSTEM OUTWARD 2 DOOR KIT
BDG0008	BIFOLD DOOR GEAR EQUIVALENT OF BARRIERFOLD SLIDING DOOR SYSTEM OUTWARD 3 DOOR KIT
BDG0009	BIFOLD DOOR GEAR EQUIVALENT OF BARRIERFOLD SLIDING DOOR SYSTEM OUTWARD 4 DOOR KIT
BDG0010	BIFOLD DOOR GEAR EQUIVALENT OF BARRIERFOLD SLIDING DOOR SYSTEM OUTWARD 5 DOOR KIT
BDG0011	BIFOLD DOOR GEAR EQUIVALENT OF BARRIERFOLD SLIDING DOOR SYSTEM OUTWARD 2+2 DOOR KIT

FEATURES:-

- Maximum door weight 90kg
- Maximum door height 3300mm
- Maximum door width 1000mm
- Door thickness 35-56mm

SLIDING DOOR GEAR BOTTOM ROLLING



TECHNICAL DATA

ITEM CODE	ITEM
BDG0051	BIFOLD DOOR GEAR BOTTOM ROLLING 1 DOOR KIT HINGE ONLY
BDG0052	BIFOLD DOOR GEAR BOTTOM ROLLING 2 DOOR KIT LEFT HANDED
BDG0053	BIFOLD DOOR GEAR BOTTOM ROLLING 3 DOOR KIT
BDG0054	BIFOLD DOOR GEAR BOTTOM ROLLING 4 DOOR KIT LEFT HANDED
BDG0055	BIFOLD DOOR GEAR BOTTOM ROLLING 5 DOOR KIT
BDG0056	BIFOLD DOOR GEAR BOTTOM ROLLING 2+2 DOOR KIT
BDG0057	BIFOLD DOOR GEAR BOTTOM ROLLING 2 DOOR KIT RIGHT HANDED
BDG0058	BIFOLD DOOR GEAR BOTTOM ROLLING 4 DOOR KIT RIGHT HANDED

FEATURES:-

- Maximum door weight 90kg
- Maximum door height 3300mm
- Maximum door width 900mm



Note

A series of horizontal dotted lines for writing.



Garg



PANIC EXIT HARDWARE

PANIC BAR (0001 SERIES)



**Single Door Panic Latch
PBSD0001**

FEATURES:-

- Suitable for single door application
- Conforms to BSEN : 1125 Standard
- Easy change from Left & Right Handles
- Surface mounted
- Push bar type
- Supplied with fixings
- Silver, Grey, Black Finishes available other finishes on request



**Double Door Panic Latch
PBDD0001**

FEATURES:-

- Suitable for single & double door application
- Conforms to BSEN : 1125 Standard
- Non handed
- Surface mounted
- Push bar type
- Supplied with fixings
- Silver, Grey, Black Finishes available other finishes on request



**Outside Access Device
PBET0001**

FEATURES:-

- Suitable for single & double door application
- Easy change from L & R
- Surface mounted
- Supplied with fixings
- Silver, Grey, Black Finishes available other finishes on request

PANIC BAR (0200 SERIES)



Single Door Panic Latch
PBSD0200
PBSD0210

FEATURES:-

- Suitable for single door application
- Conforms to BSEN : 1125 Standard
- Easy change from L & R
- Surface mounted
- Push bar type
- Supplied with fixings
- Silver, Grey, Black Finishes available
- Other finishes on request



Single Door Panic Bolt
PBDD0200
PBDD0210

FEATURES:-

- Suitable for single & double door application
- Conforms to BSEN : 1125 Standard
- Non handed
- Surface mounted
- Push bar type
- Supplied with fixings
- Silver, Grey, Black Finishes available
- Other finishes on request



Single Door Panic Bolt with
Vertical Pullman Latch
PBDD0201
PBDD0211

FEATURES:-

- Suitable for single door application
- Conforms to BSEN : 1125 Standard
- Easy change from L & R
- Surface mounted
- Push bar type
- Supplied with fixings
- Set of Panic Latch & Panic Bolt
- Silver, Grey, Black Finishes available
- Other finishes on request

PANIC BAR (0200 SERIES)



Single Door Push Pad Bolt
PBPB0200
PBPB0210

FEATURES:-

- Suitable for single & double door application
- Conforms to BSEN : 179 Standard
- Surface mounted
- Push bar type
- Supplied with fixings
- Silver, Grey, Black Finishes available
Other finishes on request



**Single Door Push Pad Bolt with
Vertical Pullman Latch**
PBPB0201
PBPB02011

FEATURES:-

- Suitable for single & double door application
- Conforms to BSEN : 179 Standard
- Surface mounted
- Push bar type
- Supplied with fixings
- Silver, Grey, Black Finishes available
Other finishes on request



Single Door Push Pad Latch
PBPL0200
PBPL0210

FEATURES:-

- Suitable for single door application
- Conforms to BSEN : 179 Standard
- Universal
- Surface mounted
- Push bar type
- Supplied with fixings
- Silver, Grey, Black Finishes available
Other finishes on request

PANIC BAR (0200 SERIES)



Rebated Double Door Panic Bar Set
PBRD0200
PBRD0210

FEATURES:-

- Suitable for double door application
- Conforms to BSEN : 1125 Standard
- Non handed
- Surface mounted
- Push bar type
- Supplied with fixings
- Silver, Grey, Black Finishes available
Other finishes on request
- Set of PBSD0200 & PBDD200
PBSD0210 & PBDD0210



Rebated Double Door Panic Bar Set
With Vertical Pullman Latch
PBRD0201
PBRD0211

FEATURES:-

- Suitable for double door application
- Conforms to BSEN : 1125 Standard
- Non handed
- Surface mounted
- Push bar type
- Supplied with fixings
- Silver, Grey, Black Finishes available
Other finishes on request
- Set of PBSD0200 & PBDD210
PBSD0210 & PBDD0210

OUTSIDE ACCESS DEVICE (0200 SERIES)



Knob
PBET0201

FEATURES:-

- Suitable for single & double door application
- Easy change from L & R
- Surface mounted
- Supplied with fixings
- Silver, Grey, Black Finishes available
Other finishes on request



OUTSIDE ACCESS DEVICE (0200 SERIES)



**Lever Handle
PBET0200**

FEATURES:-

- Suitable for single & double door application
- Easy change from L & R
- Surface mounted
- Supplied with fixings
- Silver, Grey, Black Finishes available
Other finishes on request

PANIC BAR (0300 SERIES)



**Single Door Panic Latch
PBSD0300
PBSD 0310**

FEATURES:-

- Suitable for single door application
- Conforms to BSEN : 1125 Standard
- Easy change from L & R
- Surface mounted
- Push bar type
- Supplied with fixings
- Silver, Grey, Black Finishes available
Other finishes on request



**Single Door Panic Bolt
PBDD0300
PBDD 0310**

FEATURES:-

- Suitable for single & double door application
- Conforms to BSEN : 1125 Standard
- Non Handed
- Surface mounted
- Push bar type
- Supplied with fixings
- Silver, Grey, Black Finishes available
Other finishes on request



PANIC BAR (0300 SERIES)



Single Door Panic Bolt
With Vertical Pullman Latch
PBDD0301
PBDD0311

FEATURES:-

- Suitable for single & double door application
- Conforms to BSEN : 1125 Standard
- Non Handed
- Surface mounted
- Push bar type
- Supplied with fixings
- Silver, Grey, Black Finishes available
Other finishes on request



Rebated Double Door Panic Bar Set
PBRD0300
PBRD0310

FEATURES:-

- Suitable for single & double door application
- Conforms to BSEN : 1125 Standard
- Easy change from L & R
- Surface mounted
- Push bar type
- Supplied with fixings
- Silver, Grey, Black Finishes available
Other finishes on request
- Set of PBSD0300 & PBSD0301



Rebated Double Door Panic Bar Set
with vertical Pullman Latch
PBRD0301
PBDD0311

FEATURES:-

- Suitable for single & double door application
- Conforms to BSEN : 1125 Standard
- Easy change from L & R
- Surface mounted
- Push bar type
- Supplied with fixings
- Silver, Grey, Black Finishes available
Other finishes on request
- Set of PBSD0301 & PBSD0311



PANIC BAR (0300 SERIES)



Single Door Push Pad Bolt
PBPB0300
PBPB0310

FEATURES:-

- Suitable for single door application
- Conforms to BSEN : 1125 Standard
- Non handed
- Surface mounted
- Push bar type
- Supplied with fixings
- Silver, Grey, Black Finishes available
Other finishes on request



Single Door Push Pad Latch
PBPL0300
PBPL0310

FEATURES:-

- Suitable for single door application
- Conforms to BSEN : 179 Standard
- Universal
- Surface mounted
- Push bar type
- Supplied with fixings
- Silver, Grey, Black Finishes available
Other finishes on request



**Single Door Push Pad Bolt
with vertical Pullman Latch**
PBPB0301
PBPB0311

FEATURES:-

- Suitable for single & double door application
- Conforms to BSEN : 179 Standard
- Universal
- Surface mounted
- Push bar type
- Supplied with fixings
- Silver, Grey, Black Finishes available
Other finishes on request



PANIC BAR (0300 SERIES)



**Outside Access Device
PBET0301 (Knob)**

FEATURES:-

- Suitable for single & double door application
- Easy change from L & R
- Surface mounted
- Supplied with fixings
- Silver, Grey, Black Finishes available
Other finishes on request



**Outside Access Device
PBET0300 (Lever Handle)**

FEATURES:-

- Suitable for single & double door application
- Easy change from L & R
- Surface mounted
- Supplied with fixings
- Silver, Grey, Black Finishes available
Other finishes on request

PANIC BAR (0400 SERIES)



**Touch Bar Panic Latch
PBSD0400
PBSD0410**

FEATURES:-

- Suitable for single door application
- Conforms to BSEN : 1125 Standard
- Surface mounted
- Push pad type
- Supplied with fixings
- Silver, Grey, Black Finishes available
Other finishes on request

PANIC BAR (0400 SERIES)



Touch Bar Panic Bolt
PBDD0400
PBDD0410

FEATURES:-

- Suitable for single & double door application
- Conforms to BSEN : 1125 Standard
- Non handed
- Surface mounted
- Push pad type
- Supplied with fixings
- Silver, Grey, Black Finishes available
Other finishes on request



Touch Bar 3 Point Panic Bolt
PB3P0400
PB3P0410

FEATURES:-

- Suitable for single & double door application
- Conforms to BSEN : 1125 Standard
- Easy change from L & R
- Surface mounted
- Push pad type
- Supplied with fixings
- Silver, Grey, Black Finishes available
Other finishes on request



**Touch Bar Rebated
Double Door Panic Bar Set**
PBRD0400
PBRD0410

FEATURES:-

- Suitable for single & double door application
- Conforms to BSEN : 1125 Standard
- Easy change from L & R
- Surface mounted
- Push pad type
- Supplied with fixings
- Silver, Grey, Black Finishes available
Other finishes on request
- Set of PBSD0400 & PBDD0400
or PBSD0401 & PBDD0401



PANIC BAR (0400 SERIES)



**Outside Access Device
PBET0400**

FEATURES:-

- Suitable for single & double door application
- Easy change from L & R
- Surface mounted
- Supplied with fixings
- Silver, Grey, Black Finishes available
Other finishes on request

PANIC BAR (0500 SERIES)

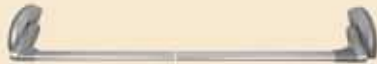

**Touch Bar Panic Latch
PBSD0500**

FEATURES:-

- Suitable for single door application
- Conforms to BSEN : 1125 Standard
- Non handed
- Surface mounted
- Push bar type
- Supplied with fixings
- Silver, Grey, Black Finishes available
Other finishes on request



**Touch Bar Panic Bolt
PBDD0500**

FEATURES:-

- Suitable for single & double door application
- Conforms to BSEN : 1125 Standard
- Non handed
- Surface mounted
- Push bar type
- Supplied with fixings
- Silver, Grey, Black Finishes available
Other finishes on request

PANIC BAR (0500 SERIES)



**Touch Bar Panic Bolt
With Vertical Pullman Latch
PBDD0501**

FEATURES:-

- Suitable for single & double door application
- Conforms to BSEN : 1125 Standard
- Non handed
- Surface mounted
- Push bar type
- Supplied with fixings
- Silver, Grey, Black Finishes available
Other finishes on request



**Touch Bar 3 Point Panic Bolt
PB3P0500**

FEATURES:-

- Suitable for single & double door application
- Conforms to BSEN : 1125 Standard
- Easy change from L & R
- Surface mounted
- Push bar type
- Supplied with fixings
- Silver, Grey, Black Finishes available
Other finishes on request



**Touch Bar 3 Point Panic Bolt
With Vertical Pullman Latch
PB3P0501**

FEATURES:-

- Suitable for single & double door application
- Conforms to BSEN : 1125 Standard
- Easy change from L & R
- Surface mounted
- Push bar type
- Supplied with fixings
- Silver, Grey, Black Finishes available
Other finishes on request



PANIC BAR (0500 SERIES)



Touch Bar Rebated Panic Bar Set
PBRD0500

FEATURES:-

- Suitable for single & double door application
- Conforms to BSEN : 1125 Standard
- Easy change from L & R
- Surface mounted
- Push bar type
- Supplied with fixings
- Silver, Grey, Black Finishes available
Other finishes on request
- Set of PBSD0500 & PBDD0500



Touch Bar Rebated Double Door
Panic Bar Set With Vertical Pullman Latch
PBRD0501

FEATURES:-

- Suitable for single & double door application
- Conforms to BSEN : 1125 Standard
- Easy change from L & R
- Surface mounted
- Push bar type
- Supplied with fixings
- Silver, Grey, Black Finishes available
Other finishes on request
- Set of PBSD0500 & PBDD0501



Push Pad Latch
PBPL0500

FEATURES:-

- Suitable for single & double door application
- Conforms to BSEN : 179 Standard
- Universal
- Surface mounted
- Push bar type
- Supplied with fixings
- Silver, Grey, Black Finishes available
Other finishes on request

PANIC BAR (0500 SERIES)



**Push Pad Bolt
PBPB0500**

FEATURES:-

- Suitable for single & double door application
- Conforms to BSEN : 179 Standard
- Universal
- Surface mounted
- Push bar type
- Supplied with fixings
- Silver, Grey, Black Finishes available
Other finishes on request



**Push Pad Bolt
With Vertical Pullman Latch
PBPB0501**

FEATURES:-

- Suitable for single & double door application
- Conforms to BSEN : 179 Standard
- Universal
- Surface mounted
- Push bar type
- Supplied with fixings
- Silver, Grey, Black Finishes available
Other finishes on request



**3 Point Push Pad
PB3B0500**

FEATURES:-

- Suitable for single & double door application
- Conforms to BSEN : 1125 Standard
- Easy change from L & R
- Surface mounted
- Push bar type
- Supplied with fixings
- Silver, Grey, Black Finishes available
Other finishes on request

PANIC BAR (0500 SERIES)



**3 Point Push Pad
With Vertical Pullman Latch
PB3B0501**

FEATURES:-

- Suitable for single & double door application
- Conforms to BSEN : 1125 Standard
- Easy change from L & R
- Surface mounted
- Push bar type
- Supplied with fixings
- Silver, Grey, Black Finishes available
Other finishes on request

PANIC BAR (0600 SERIES)



**Single Door Panic Latch
PBSD0600**

FEATURES:-

- Suitable for single door application
- Conforms to BSEN : 1125 Standard
- Non handed
- Surface mounted
- Push bar type
- Supplied with fixings
- Silver, Grey, Black Finishes available
Other finishes on request



**Single Door Panic Bolt
PBDD0600**

FEATURES:-

- Suitable for single & double door application
- Conforms to BSEN : 1125 Standard
- Non handed
- Surface mounted
- Push bar type
- Supplied with fixings
- Silver, Grey, Black Finishes available
Other finishes on request



PANIC BAR (0600 SERIES)



**Single Door Panic Bolt
With Pullman latch
PBDD0601**

FEATURES:-

- Suitable for single & double door application
- Conforms to BSEN : 1125 Standard
- Non handed
- Surface mounted
- Push bar type
- Supplied with fixings
- Silver, Grey, Black Finishes available
Other finishes on request



**Single Door 3 Point Panic Bolt
PB3P0600**

FEATURES:-

- Suitable for single & double door application
- Conforms to BSEN : 1125 Standard
- Universal
- Surface mounted
- Push bar type
- Supplied with fixings
- Silver, Grey, Black Finishes available
Other finishes on request



**Single Door 3 Point Panic Bolt
with Pullman Latch
PB3P0601**

FEATURES:-

- Suitable for single & double door application
- Conforms to BSEN : 1125 Standard
- Easy change from L & R
- Surface mounted
- Push bar type
- Supplied with fixings
- Silver, Grey, Black Finishes available
Other finishes on request

PANIC BAR (0600 SERIES)



**Single Door Push Pad Latch
PBPL0600**

FEATURES:-

- Suitable for single & double door application
- Conforms to BSEN : 179 Standard
- Universal
- Surface mounted
- Push bar type
- Supplied with fixings
- Silver, Grey, Black Finishes available
Other finishes on request



**Single Door Push Pad Bolt
PBPB0600**

FEATURES:-

- Suitable for single & double door application
- Conforms to BSEN : 179 Standard
- Universal
- Surface mounted
- Push bar type
- Supplied with fixings
- Silver, Grey, Black Finishes available
Other finishes on request



**Single Door Push Pad Bolt
With Vertical Pullman Latch
PBPB0601**

FEATURES:-

- Suitable for single & double door application
- Conforms to BSEN : 179 Standard
- Universal
- Surface mounted
- Push bar type
- Supplied with fixings
- Silver, Grey, Black Finishes available
Other finishes on request

PANIC BAR (0600 SERIES)



**3 Point Push Pad
PB3B0600**

FEATURES:-

- Suitable for single & double door application
- Conforms to BSEN : 179 Standard
- Universal
- Surface mounted
- Push bar type
- Supplied with fixings
- Silver, Grey, Black Finishes available
Other finishes on request



**3 Point Push Pad
With Vertical Pullman Latch
PB3B0601**

FEATURES:-

- Suitable for single & double door application
- Conforms to BSEN : 179 Standard
- Universal
- Surface mounted
- Push bar type
- Supplied with fixings
- Silver, Grey, Black Finishes available
Other finishes on request



**Outside Access Device
PBET0601 (Knob)**

FEATURES:-

- Suitable for single & double door application
- Easy change from L & R
- Surface mounted
- Supplied with fixings
- Silver, Grey, Black Finishes available
Other finishes on request



PANIC BAR (0600 SERIES)



**Outside Access Device
PBET0600 (Lever Handle)**

FEATURES:-

- Suitable for single & double door application
- Easy change from L & R
- Surface mounted
- Supplied with fixings
- Silver, Grey, Black Finishes available
Other finishes on request

PANIC BAR (0700 SERIES)



**Single Door Panic Latch
PBSD0700**

FEATURES:-

- Suitable for single door application
- Conforms to BSEN : 1125 Standard
- Non handed
- Surface mounted
- Push bar type
- Supplied with fixings
- Silver, Grey, Black Finishes available
Other finishes on request



**Single Door Panic Bolt
PBDD0700**

FEATURES:-

- Suitable for single & double door application
- Conforms to BSEN : 1125 Standard
- Non handed
- Surface mounted
- Push bar type
- Supplied with fixings
- Silver, Grey, Black Finishes available
Other finishes on request



PANIC BAR (0700 SERIES)



**Single Door 3 Point Panic Bolt
PB3P0700**

FEATURES:-

- Suitable for single & double door application
- Conforms to BSEN : 1125 Standard
- Easy change from L & R
- Surface mounted
- Push bar type
- Supplied with fixings
- Silver, Grey, Black Finishes available
Other finishes on request



**Rebated Double Door Panic Bar Set
PBRD0700**

FEATURES:-

- Suitable for single & double door application
- Conforms to BSEN : 1125 Standard
- Easy change from L & R
- Surface mounted
- Push bar type
- Supplied with fixings
- Silver, Grey, Black Finishes available
Other finishes on request
- Set of PBSD0700 & PBDD0700



**Single Door Push Pad Bolt
PBPB0700**

FEATURES:-

- Suitable for single & double door application
- Conforms to BSEN : 179 Standard
- Universal
- Surface mounted
- Push bar type
- Supplied with fixings
- Silver, Grey, Black Finishes available
Other finishes on request



PANIC BAR (0700 SERIES)



**Single Door Push Pad Latch
PBPL0700**

FEATURES:-

- Suitable for single & double door application
- Conforms to BSEN : 179 Standard
- Universal
- Surface mounted
- Push bar type
- Supplied with fixings
- Silver, Grey, Black Finishes available
Other finishes on request



**3 Point Push Pad
PB3B0700**

FEATURES:-

- Suitable for single & double door application
- Conforms to BSEN : 1125 Standard
- Easy change from L & R
- Surface mounted
- Push bar type
- Supplied with fixings
- Silver, Grey, Black Finishes available
Other finishes on request

PANIC BAR (0700 SERIES)



**Out Side Access Device
PBET0701 (Knob)**

FEATURES:-

- Suitable for single & double door application
- Easy change from L & R
- Surface mounted
- Supplied with fixings
- Silver, Grey, Black Finishes available
Other finishes on request



PANIC BAR (0700 SERIES)



**Out Side Access Device
PBET0700 (Lever Handle)**

FEATURES:-

- Suitable for single & double door application
- Easy change from L & R
- Surface mounted
- Supplied with fixings
- Silver, Grey, Black Finishes available
Other finishes on request

PANIC BAR (0800 SERIES)



**Touch Bar Panic Latch
PBSD0800
PBSD0801**

FEATURES:-

- Suitable for single door application
- Conforms to BSEN : 1125 Standard
- Non handed
- Surface mounted
- Push bar type
- Supplied with fixings
- Silver, Grey, Black Finishes available
Other finishes on request



**Touch Bar Panic Bolt
PBDD0800
PBDD0801**

FEATURES:-

- Suitable for single & double door application
- Conforms to BSEN : 1125 Standard
- Non handed
- Surface mounted
- Push bar type
- Supplied with fixings
- Silver, Grey, Black Finishes available
Other finishes on request

PANIC BAR (0800 SERIES)



Touch Bar 3 Point Panic Bolt
PB3P0800
PB3P0801

FEATURES:-

- Suitable for single & double door application
- Conforms to BSEN : 1125 Standard
- Easy change from L & R
- Surface mounted
- Push bar type
- Supplied with fixings
- Silver, Grey, Black Finishes available
Other finishes on request



Touch Bar Rebated
Double Door Panic Bar Set
PBRD0800
PBRD0801

FEATURES:-

- Suitable for single & double door application
- Conforms to BSEN : 1125 Standard
- Easy change from L & R
- Surface mounted
- Push bar type
- Supplied with fixings
- Silver, Grey, Black Finishes available
Other finishes on request
- Set of PBSD0800 & PBDD0800 or
PBSD0801 & PBDD0801



Outside Access Device
PBET0801

FEATURES:-

- Suitable for single & double door application
- Easy change from L & R
- Surface mounted
- Supplied with fixings
- Silver, Grey, Black Finishes available
Other finishes on request



Note

A series of horizontal dotted lines for writing.



Garg
Locks



UPVC RANGE

Visit us at : www.garglocks.com

GPV011 : UPVC LOCKING WINDOW FASTENER



TECHNICAL DATA

ITEM CODE	LENGTH	WIDTH	SCREW NO.	WT/PCS	PCS. IN INNER	PCS. IN OUTER
HHIHPV11065	139	62	8	0.206	5	60

FINISH AVAILABLE : EB, BZP, CP, EXB, SILVER, WHITE

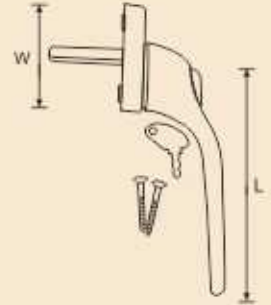

GPV076 : UPVC LOCKING WINDOW FASTENER



TECHNICAL DATA

ITEM CODE	LENGTH	WIDTH	SCREW NO.	WT/PCS	PCS. IN INNER	PCS. IN OUTER
HHNDPV76XXX	141	64	8	0.112	5	60

FINISH AVAILABLE : EB, BZP, CP, EXB, SILVER, WHITE

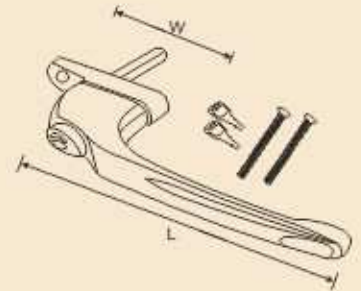

GPV077 : UPVC LOCKING WINDOW FASTENER



TECHNICAL DATA

ITEM CODE	LENGTH	WIDTH	SCREW NO.	WT/PCS	PCS. IN INNER	PCS. IN OUTER
HHNDPV77XXX	135	62	8	0.090	5	60

FINISH AVAILABLE : EB, BZP, CP, EXB, SILVER, WHITE

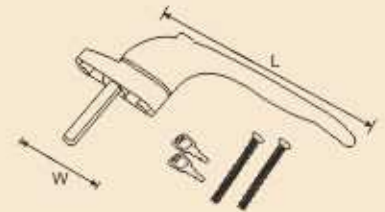

GPV070 UPVC EMBER LEVER HAND



TECHNICAL DATA

ITEM CODE	LENGTH	WIDTH	HEIGHT	THICKNESS	CENTRE DISTANCE	SCREW NO.	WT/SET	SET IN INNER	SET IN OUTER
HHNDPV70XXX	228	32	10	2.2	92	M4	0.326	01	10

FINISH AVAILABLE : EB, BZP, CP, EXB, SILVER, WHITE

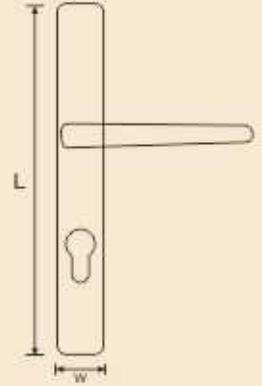

GPV092 UPVC LYLA LEVER HANDLE (SS PLATE)



TECHNICAL DATA

ITEM CODE	LENGTH	WIDTH	HEIGHT	THICKNESS	CENTRE DISTANCE	SCREW NO.	WT/SET	SET IN INNER	SET IN OUTER
HHNDPV92XXX	240	33	10	1.2	92	M4	0.454	01	10

FINISH AVAILABLE : EB, BZP, CP, EXB, SILVER, WHITE

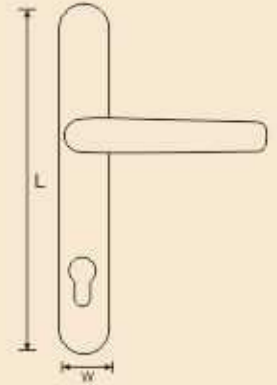

GPV093 UPVC JEMMA LEVER HANDEL



TECHNICAL DATA

ITEM CODE	LENGTH	WIDTH	HEIGHT	THICKNESS	CENTRE DISTANCE	SCREW NO.	WT/SET	SET IN INNER	SET IN OUTER
HHNDPV93XXX	240	32	10	3.0	92	M4	0.430	01	10

FINISH AVAILABLE : EB, BZP, CP, EXB, SILVER, WHITE

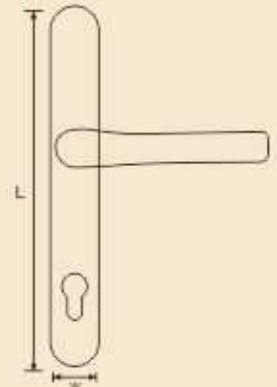

GPV094 UPVC IKON LEVER DOOR HANDEL (TYPE-1)



TECHNICAL DATA

ITEM CODE	LENGTH	WIDTH	HEIGHT	THICKNESS	CENTRE DISTANCE	SCREW NO.	WT/SET	SET IN INNER	SET IN OUTER
HHNDPV94XXX	208	29	12	1.75	92	M4	0.330	01	10

FINISH AVAILABLE : EB, BZP, CP, EXB, SILVER, WHITE

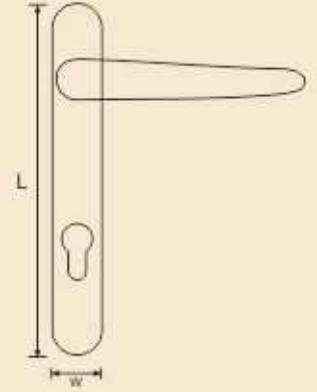

GPV095 UPVC IKON LEVER DOOR HANDLE (TYPE-2)



TECHNICAL DATA

ITEM CODE	LENGTH	WIDTH	HEIGHT	THICKNESS	CENTRE DISTANCE	SCREW NO.	WT/SET	SET IN INNER	SET IN OUTER
HHNDPV95XXX	245	33	12	1.75	92	M4	0.377	01	10

FINISH AVAILABLE : EB, BZP, CP, EXB, SILVER, WHITE

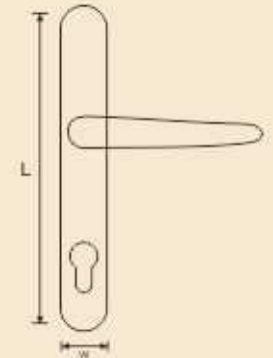

GPV025 : UPVC LETTER BOX SLIM MASTER (MODEL-1)



TECHNICAL DATA

ITEM CODE	SIZE	LENGTH	WIDTH	SCREW NO.	WT./PCS	PCS IN INNER	PCS IN OUTER
HMIHPV25XXX	12"	316	50	8	0.425	5	40

FINISH AVAILABLE : EB, BZP, CP, SILVER

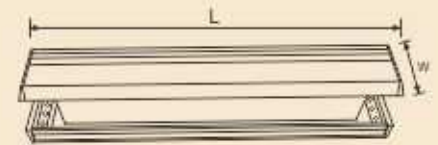

GPV026 : UPVC LETTER BOX SLEEVES & PLATE (MODEL-2)



TECHNICAL DATA

ITEM CODE	SIZE	LENGTH	WIDTH	SCREW NO.	WT/PCS	PCS IN INNER	PCS IN OUTER
HMIHPV26XXX	10"	265	70	8	0.310	5	40

FINISH AVAILABLE :EB, BZP, CP, SILVER

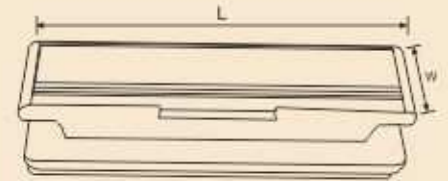

GPV027 : UPVC LETTER BOX WELSEAL (MODEL-3)



TECHNICAL DATA

ITEM CODE	SIZE	LENGTH	WIDTH	SCREW NO.	WT/PCS	PCS IN INNER	PCS IN OUTER
HMIHPV27XXX	12"	306	70	8	0.440	5	40

FINISH AVAILABLE :EB, BZP, CP, SILVER

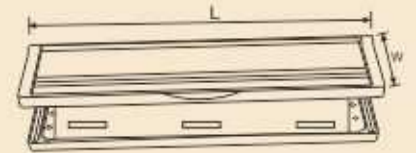

LAL0171 CABLE WINDOW RESTRICTOR (KEY LOCK)



13126-5
+
A1:2014

TECHNICAL DATA

DPG CODE	LENGTH	WIDTH	SCREW NO.	WT/PCS	PCS. IN INNER	PCS. IN OUTER
LAL0171	210	67	7	0.137	10	100

EN 13126-5:2011 - 5 015 0 3/2 3 - 5/6 A

FINISH AVAILABLE : WHITE



LAL0176 CABLE WINDOW RESTRICTOR (PUSH)



TECHNICAL DATA

DPG CODE	LENGTH	WIDTH	SCREW NO.	WT/PCS	PCS. IN INNER	PCS. IN OUTER
LAL0176	210	67	7	0.143	10	100

FINISH AVAILABLE : WHITE

