



Garg

IRONMONGERY



Visit us at : www.garglocks.com

923SS : STAINLESS STEEL TOWER BOLT

TECHNICAL DATA

ITEM CODE	SIZE	LENGTH	WIDTH	SHOOT DIA	SCREW NO.	WT/PCS	PCS. IN INNER	PCS. IN OUTER	PCS. IN PALLET
SIRN0923075	3"	75	33	10	4	0.084	10	240	8160
SIRN0923100	4"	100	33	10	4	0.130	10	160	5440
SIRN0923150	6"	150	33	10	4	0.158	10	140	4200
SIRN0923200	8"	200	33	10	4	0.216	10	100	3000
SIRN0923250	10"	250	33	10	6	0.252	10	80	1920
SIRN0923300	12"	300	33	10	6	0.307	10	60	1800

FINISH AVAILABLE : EB, SATIN, MIRROR POLISHED

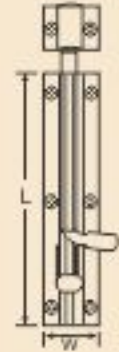
STAINLESS STEEL BARREL BOLT (STANDARD)

TECHNICAL DATA

ITEM CODE	SIZE	LENGTH	WIDTH	SHOOT DIA	SCREW NO.	WT/PCS	PCS. IN INNER	PCS. IN OUTER	PCS. IN PALLET
SIRN0887038	1.5"	40	27	6.9	4	0.042	10	400	16000
SIRN0888050	2"	50	27	6.9	4	0.047	10	400	16000
SIRN0889065	2.5"	65	27	6.9	4	0.056	10	340	12240
SIRN0890075	3"	75	27	6.9	4	0.066	10	300	10800
SIRN0891100	4"	100	27	6.9	4	0.086	10	200	9000
SIRN0892150	6"	150	27	6.9	4	0.124	10	160	6400

FINISH AVAILABLE : EB, SATIN, MIRROR POLISHED

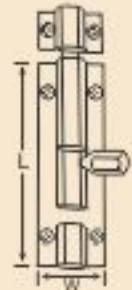
STAINLESS STEEL BARREL BOLT (HEAVY)

TECHNICAL DATA

ITEM CODE	SIZE	LENGTH	WIDTH	SHOOT DIA	SCREW NO.	WT/PCS	PCS. IN INNER	PCS. IN OUTER	PCS. IN PALLET
SIRN0891100	4"	100	38	10.8	6	0.154	10	120	5400
SIRN0893150	6"	152	38	10.8	6	0.218	10	80	3120
SIRN0894200	8"	200	38	10.8	6	0.282	10	60	2700
SIRN0895250	10"	250	38	10.8	6	0.346	10	60	1980

FINISH AVAILABLE : EB, SATIN, MIRROR POLISHED

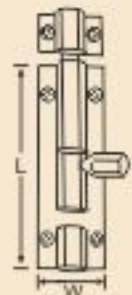

STAINLESS STEEL BARREL BOLT NECKED (STANDARD)

TECHNICAL DATA

ITEM CODE	SIZE	LENGTH	WIDTH	SHOOT DIA	SCREW NO.	WT/PCS	PCS. IN INNER	PCS. IN OUTER	PCS. IN PALLET
SIRN888N050	2"	50	27	6.9	4	0.047	10	400	16000
SIRN889N065	2.5"	65	27	6.9	4	0.056	10	340	12240
SIRN890N075	3"	75	27	6.9	4	0.066	10	300	10800
SIRN891N100	4"	100	27	6.9	4	0.086	10	200	9000
SIRN892N150	6"	150	27	6.9	4	0.124	10	160	6400

FINISH AVAILABLE : EB, SATIN, MIRROR POLISHED

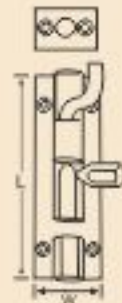
STAINLESS STEEL BARREL BOLT NECKED (HEAVY)

TECHNICAL DATA

ITEM CODE	SIZE	LENGTH	WIDTH	SHOOT DIA	SCREW NO.	WT/PCS	PCS. IN INNER	PCS. IN OUTER	PCS. IN PALLET
SIRN0791100	4"	100	38	10	6	0.154	10	120	5400
SIRN893N150	6"	152	38	10	6	0.218	10	80	3120
SIRN894N200	8"	200	38	10	6	0.282	10	60	2700
SIRN895N250	10"	250	38	10	6	0.346	10	60	1980

FINISH AVAILABLE : EB, SATIN, MIRROR POLISHED

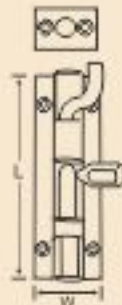
880SS : STAINLESS STEEL SPRING ACTION TOWER BOLT

TECHNICAL DATA

ITEM CODE	SIZE	LENGTH	WIDTH	SHOOT DIA	BOLT	WT/PC	PCS. IN INNER	PCS. IN OUTER	PCS. IN PALLET
SIRN0880250	10"	260	53	15	M8	0.728	5	10	900

FINISH AVAILABLE : EB, SATIN, MIRROR POLISHED



881SS : STAINLESS STEEL CONCEALED TOWER BOLT



TECHNICAL DATA

ITEM CODE	SIZE	ROD LENGTH (L1)	LENGTH (L2)	WIDTH	THICKNESS	ROD DIA.	SCREW NO.	WT./PCS	PCS. IN INNER	PCS. IN OUTER
SIRN08B1150	6"	152	171	24	2.00	M8	7	0.218	10	50
SIRN08B1200	8"	203	171	24	2.00	M8	7	0.233	10	50
SIRN08B1250	10"	254	171	24	2.00	M8	7	0.247	10	50
SIRN08B1300	12"	304	171	24	2.00	M8	7	0.261	10	50
SIRN08B1350	14"	355	171	24	2.00	M8	7	0.275	10	50
SIRN08B1400	16"	406	171	24	2.00	M8	7	0.289	10	50
SIRN08B1450	18"	457	171	24	2.00	M8	7	0.303	10	50
SIRN08B1500	20"	508	171	24	2.00	M8	7	0.317	10	50
SIRN08B1600	24"	609	171	24	2.00	M8	7	0.345	10	50

FINISH AVAILABLE : EB, SATIN, MIRROR POLISHED

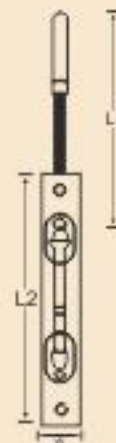

923A : MILD STEEL TOWER BOLT



TECHNICAL DATA

ITEM CODE	SIZE	LENGTH	WIDTH	THICKNESS	SHOOT DIA	SCREW NO.	WT./PCS	PCS. IN INNER	PCS. IN OUTER	PCS. IN PALLET
MIRN923A075	3"	85	38	0.8	10	6	0.107	10	200	8000
MIRN923A100	4"	110	38	0.8	10	6	0.135	10	120	5400
MIRN923A125	5"	135	38	0.8	10	6	0.150	10	100	4800
MIRN923A150	6"	160	38	0.8	10	6	0.192	10	80	4000
MIRN923A200	8"	210	45	1.0	12	6	0.370	10	50	2000
MIRN923A250	10"	260	45	1.0	12	6	0.449	10	40	1440
MIRN923A300	12"	310	45	1.0	12	6	0.531	10	30	1200

FINISH AVAILABLE : EXB, TEXTURE BLK, EXW, ZP, DUROSIL, HSG



923L : MILD STEEL TOWER BOLT (ECO)



TECHNICAL DATA

ITEM CODE	SIZE	LENGTH	WIDTH	THICKNESS	SHOOT DIA	SCREW NO.	WT./PCS	PCS. IN INNER	PCS. IN OUTER	PCS. IN PALLET
MIRN923L075	3"	85	38	0.8	9	6	0.090	10	200	8000
MIRN923L100	4"	110	38	0.8	9	6	0.115	10	120	5400
MIRN923L150	6"	160	38	0.8	9	6	0.162	10	80	4000

FINISH AVAILABLE : EXB, TEXTURE BLK, EXW, ZP, DUROSIL, HSG



923N : MILD STEEL NECKED TOWER BOLT



TECHNICAL DATA

ITEM CODE	SIZE	LENGTH	WIDTH	SHOOT DIA	SCREW NO.	WT./PCS	PCS. IN INNER	PCS. IN OUTER	PCS. IN PALLET
MIRN923N100	4"	110	38	10	8	0.126	10	120	5400
MIRN923N150	6"	160	38	10	6	0.188	10	80	4000
MIRN923N200	8"	210	45	12	6	0.348	10	50	2000
MIRN923N250	10"	260	45	12	6	0.467	10	40	1440

FINISH AVAILABLE : EXB, TEXTURE BLK, EXW, ZP, DUROSIL, HSG

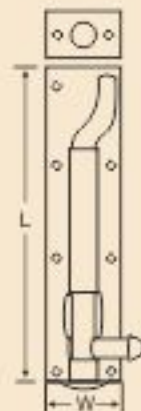

923SA : MILD STEEL BARREL BOLT



TECHNICAL DATA

ITEM CODE	SIZE	LENGTH	WIDTH	THICKNESS	SHOOT DIA	BOLT	WT./PCS	PCS. IN INNER	PCS. IN OUTER	PCS. IN PALLET
MIRN92SA100	4"	117	43	1.6	12	M5	0.183	10	100	4200
MIRN92SA150	6"	167	43	1.6	12	M5	0.264	10	80	2560
MIRN92SA200	8"	217	43	1.6	12	M5	0.375	10	60	1920
MIRN92SA250	10"	267	43	1.6	12	M5	0.426	10	40	1920

FINISH AVAILABLE : EXB, TEXTURE BLK, EXW, ZP, DUROSIL, HSG

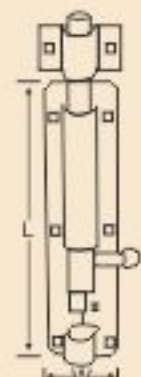

923H : MILD STEEL SECTIONAL TOWER BOLT



TECHNICAL DATA

ITEM CODE	SIZE	LENGTH	WIDTH	SHOOT DIA	SCREW NO.	WT./PCS	PCS. IN INNER	PCS. IN OUTER	PCS. IN PALLET
MIRN923H075	3"	75	33	10	6	0.135	10	200	6000
MIRN923H100	4"	100	33	10	6	0.165	10	150	5400
MIRN923H125	5"	125	33	10	6	0.210	10	100	3200
MIRN923H150	6"	150	33	10	6	0.240	10	80	2560
MIRN923H150	6"	150	38	12	6	0.280	10	50	2500
MIRN923H200	8"	200	33	10	6	0.420	10	40	2000
MIRN923H200	8"	200	38	12	6	0.446	10	40	1600

FINISH AVAILABLE : EXB, TEXTURE BLK, EXW, ZP, DUROSIL, HSG



922A : MILD STEEL BUDGET STRAIGHT BARREL BOLT HEX KNOB

TECHNICAL DATA

ITEM CODE	SIZE	LENGTH	WIDTH	SHOOT DIA	SCREW NO.	WT./PCS	PCS. IN INNER	PCS. IN OUTER	PCS. IN PALLET
MIRN922A038	1.5"	40	27	6.9	4	0.042	10	400	16000
MIRN922A050	2"	50	27	6.9	4	0.047	10	400	16000
MIRN922A065	2.5"	65	27	6.9	4	0.055	10	340	12240
MIRN922A075	3"	75	27	6.9	4	0.065	10	300	10800
MIRN922A100	4"	100	27	6.9	4	0.085	10	200	9000
MIRN922A150	6"	150	27	6.9	4	0.125	10	160	6400

FINISH AVAILABLE : BZP, EB, SCP, PCP

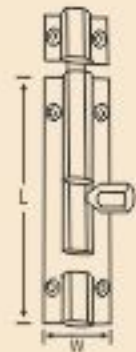
922N : MILD STEEL BUDGET BARREL BOLT NECKED HEX KNOB

TECHNICAL DATA

ITEM CODE	SIZE	LENGTH	WIDTH	SHOOT DIA	SCREW NO.	WT./PCS	PCS. IN INNER	PCS. IN OUTER	PCS. IN PALLET
MIRN922N063	2.5"	65	27	6.9	4	0.055	10	340	12240
MIRN922N075	3"	75	27	6.9	4	0.065	10	300	10800
MIRN922N100	4"	100	27	6.9	4	0.085	10	200	9000
MIRN922N150	6"	150	27	6.9	4	0.125	10	160	6400

FINISH AVAILABLE : BZP, EB, SCP, PCP

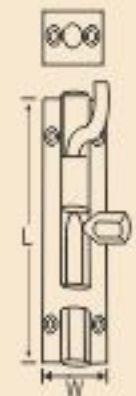
1258 : MILD STEEL BARREL BOLT

TECHNICAL DATA

ITEM CODE	SIZE	LENGTH	WIDTH	THICKNESS	SCREW NO.	SHOOT DIA	WT./PCS	PCS. IN INNER	PCS. IN OUTER	PCS. IN PALLET
MIRN1258038	1.5"	35	39.5	1.2	7	7.8	0.060	20	400	12800
MIRN1258050	2"	45	39.5	1.2	7	7.8	0.060	20	300	10800
MIRN1258075	3"	55	39.5	1.2	7	7.8	0.070	10	200	9000
MIRN1258100	4"	77	39.5	1.2	7	7.8	0.090	10	200	9000

FINISH AVAILABLE : EXB, TEXTURE BLK, EXW, ZP, DUROSIL, HSG

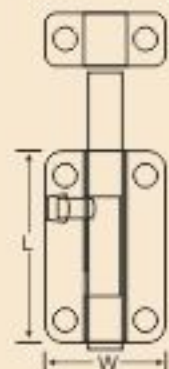

1258H : MILD STEEL HEAVY BARREL BOLT

TECHNICAL DATA

ITEM CODE	SIZE	LENGTH	WIDTH	THICKNESS	SCREW NO.	SHOOT DIA	WT./PCS	PCS. IN INNER	PCS. IN OUTER	PCS. IN PALLET
MIRN1258075	3"	83	42	1.6	7	10	0.150	10	100	4800
MIRN1258100	4"	114	42	1.6	7	10	0.200	10	100	3600

FINISH AVAILABLE : EXB, TEXTURE BLK, EXW, ZP, DUROSIL, HSG

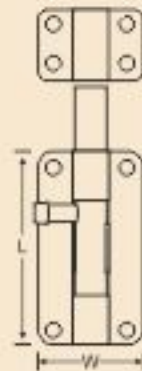
BRASS HEAVY DUTY STRAIGHT BARREL BOLT-HEX KNOB

TECHNICAL DATA

DPG CODE	ITEM CODE	LENGTH	WIDTH	THICKNESS	SHOOT DIA	SCREW NO.	WT/ PCS	PCS. IN INNER	PCS. IN OUTER	PCS. IN PALLET
GB0893	BMIH0893150	152	30	1.2	8.4	6	0.174	10	100	4000
GB0894	BMIH0894200	205	30	1.2	8.8	6	0.256	5	80	2880
GB0895	BMIH0895250	250	30	1.2	8.8	6	0.338	5	60	2160
GB0896	BMIH0896300	300	30	1.2	8.8	6	0.420	5	40	1600

FINISH AVAILABLE : POLISHED & LACQUERED BRASS/CP/SNP

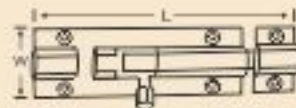
BRASS STRAIGHT BARREL BOLT HEX KNOB

TECHNICAL DATA

DPG CODE	ITEM CODE	LENGTH	WIDTH	THICKNESS	SHOOT DIA	SCREW NO.	WT/ PCS	PCS. IN INNER	PCS. IN OUTER	PCS. IN PALLET
GB0887	BMIH0887038	38	25	0.9	6.8	4	0.036	20	400	16000
GB0888	BMIH0888050	50	25	0.9	6.8	4	0.039	20	400	16000
GB0889	BMIH0889065	63	25	0.9	6.8	4	0.049	20	300	12000
GB0890	BMIH0890075	75	25	0.9	6.8	4	0.060	10	250	10000
GB0891	BMIH0891100	100	25	0.9	6.8	4	0.082	10	200	9000
GB0892	BMIH0892150	150	25	0.9	6.8	4	0.123	10	140	5600

FINISH AVAILABLE : POLISHED & LACQUERED BRASS/CP/SNP



BRASS NECKED BARREL BOLT HEX KNOB



TECHNICAL DATA

DPG CODE	ITEM CODE	LENGTH	WIDTH	THICKNESS	SHOOT DIA	SCREW NO.	WT/ PCS	PCS. IN INNER	PCS. IN OUTER	PCS. IN PALLET
GB0889N	BMH889M065	63	25	0.9	6.8	4	0.051	20	300	12000
GB0897	BMH0897075	75	25	0.9	6.8	4	0.062	10	250	10000
GB0898	BMH0898100	100	25	0.9	6.8	4	0.080	10	200	9000
GB0899	BMH0899150	150	25	0.9	6.8	4	0.123	10	140	5600



FINISH AVAILABLE : POLISHED & LACQUERED BRASS/CP/SNP

BRASS SHAPED BARREL BOLT



TECHNICAL DATA

DPG CODE	ITEM CODE	LENGTH	WIDTH	THICKNESS	SHOOT DIA	SCREW NO.	WT/ PCS	PCS. IN INNER	PCS. IN OUTER	PCS. IN PALLET
GB0914	BMH0914090	95	30	1.3	8.3	6	0.120	10	120	6000

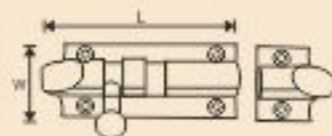

FINISH AVAILABLE : POLISHED & LACQUERED BRASS/CP/SNP

BRASS SHAPED NECKED BARREL BOLT



TECHNICAL DATA

DPG CODE	ITEM CODE	LENGTH	WIDTH	THICKNESS	SHOOT DIA	SCREW NO.	WT/ PCS	PCS. IN INNER	PCS. IN OUTER	PCS. IN PALLET
GB0915	BMH0915090	95	30	1.3	8.3	6	0.105	10	120	6000

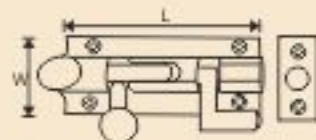

FINISH AVAILABLE : POLISHED & LACQUERED BRASS/CP/SNP

BRASS TOP SLIDE BOLT

TECHNICAL DATA



DPG CODE	ITEM CODE	LENGTH	WIDTH	SCREW NO.	WT/ PCS	PCS. IN INNER	PCS. IN OUTER	PCS. IN PALLET
GB0908	BMH0908115	111	24	6	0.088	10	200	9000
GB0909	BMH0909150	145	32	6	0.188	10	100	4000
GB0910	BMH0910195	195	40	6	0.294	5	60	2400



FINISH AVAILABLE : POLISHED & LACQUERED BRASS/CP/SNP

BRASS SPRING TOWER BOLT 3" (75mm)



GB0901

BRASS OVAL SHAPED TOWER BOLT 4"



GB0902

BRASS BARREL TOWER BOLT 4"



GB0903

BRASS GEORGIAN BARREL BOLT



GB0904 (4")
GB0906 (6")

BRASS STRAIGHT TOWER BOLT



GB0911 (4")
GB0912 (6")

ALUMINIUM BARREL BOLT

TECHNICAL DATA



DPG CODE	ITEM CODE	LENGTH	WIDTH	THICKNESS	SHOOT DIA	SCREW NO.	WT/ PCS	PCS. IN INNER	PCS. IN OUTER	PCS. IN PALLET
GA1600	AIRN1600038	38	25	0.7	7.5	4	0.019	10	450	10800
GA1601	AIRN1601050	50	25	0.7	7.5	4	0.023	10	450	10800
GA1602	AIRN1602063	63	25	0.9	7.5	4	0.030	10	400	10800
GA1603	AIRN1603075	75	25	0.9	7.5	4	0.036	10	300	10800
GA1604	AIRN1604100	100	25	0.9	7.5	4	0.048	10	250	9000
GA1605	AIRN1605150	150	25	1.0	7.5	4	0.070	10	160	5120

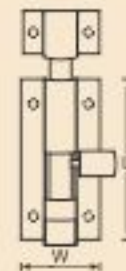

FINISH AVAILABLE : SAA

ALUMINIUM NECKED BARREL BOLT

TECHNICAL DATA

DPG CODE	ITEM CODE	LENGTH	WIDTH	THICKNESS	SCREW NO.	WT/ PCS	PCS. IN INNER	PCS. IN OUTER	PCS. IN PALLET
GA1651	AIRW1651075	75	25	0.9	4	0.035	10	300	10800
GA1652	AIRW1652100	100	25	0.9	4	0.047	10	250	9000
GA1653	AIRW1653150	150	25	1.0	4	0.070	10	160	5120

FINISH AVAILABLE : SAA

BLACK ANTIQUE STRAIGHT DOOR BOLT WITH KNOB

TECHNICAL DATA

DPG CODE	ITEM CODE	SIZE	LENGTH	WIDTH	SCREW NO.	WT/ PCS	PCS. IN INNER	PCS. IN OUTER	PCS. IN PALLET
G0366	CIRN0366075	3"	86	31	7	0.130	10	140	5040
G0368	CIRN0368100	4"	102	33	7	0.160	10	100	4000

FINISH AVAILABLE : EXB, DUROSIL, PEWTER

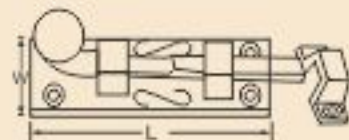
BLACK ANTIQUE NECKED DOOR BOLT WITH KNOB

TECHNICAL DATA

DPG CODE	ITEM CODE	SIZE	LENGTH	WIDTH	SCREW NO.	WT/ PCS	PCS. IN INNER	PCS. IN OUTER	PCS. IN PALLET
G0374	CIRN0374075	3"	78	31	6	0.148	10	120	4800

FINISH AVAILABLE : EXB, DUROSIL, PEWTER



BLACK ANTIQUE CURLY TAIL DOOR BOLT

TECHNICAL DATA

DPG CODE	ITEM CODE	SIZE	LENGTH	WIDTH	SCREW NO.	WT/ PCS	PCS. IN INNER	PCS. IN OUTER	PCS. IN PALLET
G0376	CIRN0376075	3"	85	31	7	0.133	10	140	5040
G0377	CIRN0377100	4"	102	33	7	0.143	10	120	4320

FINISH AVAILABLE : EXB, DUROSIL, PEWTER

BLACK ANTIQUE CURLY TAIL NECKED DOOR BOLT

TECHNICAL DATA

DPG CODE	ITEM CODE	SIZE	LENGTH	WIDTH	SCREW NO.	WT/ PCS	PCS. IN INNER	PCS. IN OUTER	PCS. IN PALLET
G0378	CIRN0378075	3"	78	31	7	0.132	10	120	5400

FINISH AVAILABLE : EXB, DUROSIL, PEWTER

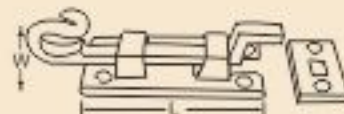
BLACK ANTIQUE SCROLL STRAIGHT DOOR BOLT

TECHNICAL DATA

DPG CODE	ITEM CODE	SIZE	LENGTH	WIDTH	SCREW NO.	WT/ PCS	PCS. IN INNER	PCS. IN OUTER	PCS. IN PALLET
G0900	CIRN0900100	4"	110	40	7	0.154	5	100	4000
G0901	CIRN0901125	5"	115	45	7	0.204	5	90	2880
G0901A	CIRN0902150	6"	163	45	7	0.330	5	60	2160
G0902	CIRN0903200	8"	185	52	8	0.456	5	40	1440

FINISH AVAILABLE : EXB, DUROSIL, PEWTER



BLACK ANTIQUE SCROLL NECKED DOOR BOLT
TECHNICAL DATA

DPG CODE	ITEM CODE	SIZE	LENGTH	WIDTH	SCREW NO.	WT/ PCS	PCS. IN INNER	PCS. IN OUTER	PCS. IN PALLET
G0900N	CIRN900N100	4"	112	40	7	0.223	5	80	3200
G0901N	CIRN901N125	5"	120	45	7	0.242	5	80	3200
G0901AN	CIRN902N150	6"	163	45	7	0.330	5	60	2160
G0902N	CIRN902N200	8"	185	52	8	0.460	5	40	1600

FINISH AVAILABLE : EXB, DUROSIL, PEWTER

1A : MILD STEEL HEAVY PADBOLT, BRENTON PATTERN
TECHNICAL DATA

ITEM CODE	SIZE	SHOOT LENGTH	LENGTH	WIDTH	THICKNESS	SCREW NO.	SHOOT DIA	WT/ PCS	PCS. IN INNER	PCS. IN OUTER	PCS. IN PALLET
MIRN001A150	6"	151	171	58	1.9	6	16	0.533	5	40	1360
MIRN001A200	8"	201	222	58	1.9	6	16	0.654	5	35	945
MIRN001A250	10"	251	275	58	1.9	6	16	0.772	5	25	900
MIRN001A300	12"	301	322	58	1.9	6	16	0.907	5	20	720

FINISH AVAILABLE : EXB, TEXTURE BLK, EXW, ZP, DUROSIL, EVER BLACK, HSG

1AL : MILD STEEL HEAVY PADBOLT, BRENTON PATTERN (ECO)
TECHNICAL DATA

ITEM CODE	SIZE	SHOOT LENGTH	LENGTH	WIDTH	THICKNESS	SCREW NO.	SHOOT DIA	WT/ PCS	PCS. IN INNER	PCS. IN OUTER	PCS. IN PALLET
MIRN001A150	6"	150	171	58	1.55	6	14	0.456	5	40	1360
MIRN001A200	8"	200	222	58	1.55	6	14	0.541	5	35	945
MIRN001A250	10"	250	271	58	1.55	6	14	0.638	5	25	900
MIRN001A300	12"	300	322	58	1.55	6	14	0.728	5	20	720

FINISH AVAILABLE : EXB, TEXTURE BLK, EXW, ZP, DUROSIL, HSG

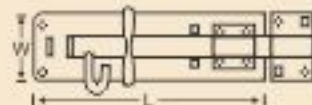

2A : MILD STEEL MEDIUM PADBOLT, BRENTON PATTERN
TECHNICAL DATA

ITEM CODE	SIZE	SHOOT LENGTH	LENGTH	WIDTH	THICKNESS	SCREW NO.	SHOOT DIA	WT/ PCS	PCS. IN INNER	PCS. IN OUTER	PCS. IN PALLET
MIRN002A100	4"	101	120	45	1.5	6	12	0.242	5	80	2880
MIRN002A150	6"	152	172	45	1.5	6	12	0.305	5	60	2040
MIRN002A200	8"	202	220	45	1.5	6	12	0.385	5	50	1200
MIRN002A250	10"	252	272	45	1.5	6	12	0.452	5	40	1080
MIRN002A300	12"	302	322	45	1.5	6	12	0.530	5	35	980

FINISH AVAILABLE : EXB, TEXTURE BLK, EXW, ZP, DUROSIL, HSG

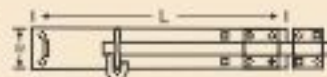
2AL : MILD STEEL MEDIUM PADBOLT, BRENTON PATTERN (ECO)
TECHNICAL DATA

ITEM CODE	SIZE	SHOOT LENGTH	LENGTH	WIDTH	THICKNESS	SCREW NO.	SHOOT DIA	WT/ PCS	PCS. IN INNER	PCS. IN OUTER	PCS. IN PALLET
MIRN02AL100	4"	100	120	45	1.2	6	10	0.208	5	80	2880
MIRN02AL150	6"	150	170	45	1.2	6	10	0.246	5	60	2040
MIRN02AL200	8"	200	220	45	1.2	6	10	0.313	5	50	1200
MIRN02AL250	10"	250	272	45	1.2	6	10	0.366	5	40	1080
MIRN02AL300	12"	300	322	45	1.2	6	10	0.410	5	35	980

FINISH AVAILABLE : EXB, TEXTURE BLK, EXW, ZP, DUROSIL, HSG

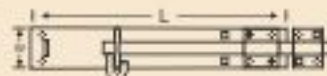
4A : MILD STEEL OVAL PAD BOLT
TECHNICAL DATA

ITEM CODE	SIZE	SHOOT LENGTH	LENGTH	WIDTH	THICKNESS	BOLT	SHOOT DIA	WT/ PCS	PCS. IN INNER	PCS. IN OUTER	PCS. IN PALLET
MIRN004A100	4"	115	102	54	2.0	M6	12	0.280	10	80	1920

FINISH AVAILABLE : EXB, TEXTURE BLK, EXW, ZP, DUROSIL, HSG

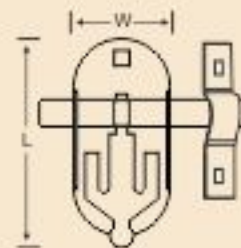

4ASA : MILD STEEL OVAL PADBOLT

TECHNICAL DATA

ITEM CODE	SIZE	SHOOT LENGTH	LENGTH	WIDTH	THICKNESS	SHOOT DIA	BOLT	WT/ PCS	PCS. IN INNER	PCS. IN OUTER	PCS. IN PALLET
MIRN4ASA100	4"	115	75	55	2.0	12	M6	0.243	10	80	1920

FINISH AVAILABLE : EXB, TEXTURE BLK, EXW, ZP, DUROSIL, HSG

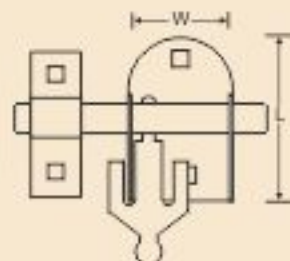
5A : MILD STEEL DOOR BOLT FOR PADLOCK

TECHNICAL DATA

ITEM CODE	SIZE	SHOOT LENGTH	LENGTH	WIDTH	THICKNESS	SCREW NO.	WT/ PCS	PCS. IN INNER	PCS. IN OUTER	PCS. IN PALLET
MIRN005A100	4"	94	101	43	2.2	6	0.130	10	120	5400
MIRN005A120	5"	107	121	45	2.1	6	0.160	10	100	3600
MIRN005A160	6"	144	160	53	2.2	6	0.310	5	60	2040

FINISH AVAILABLE : EXB, TEXTURE BLK, EXW, ZP, DUROSIL, HSG

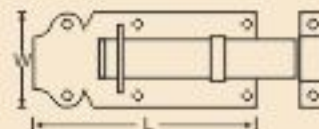
6A : MILD STEEL SLIMLINE PADBOLT

TECHNICAL DATA

ITEM CODE	SIZE	SHOOT LENGTH	LENGTH	WIDTH	THICKNESS	SCREW NO.	WT/ PCS	PCS. IN INNER	PCS. IN OUTER	PCS. IN PALLET
MIRN006A100	4"	112	68	32	2.0	6	0.112	10	120	5400
MIRN006A150	6"	144	95	46	2.0	8	0.282	5	60	2040

FINISH AVAILABLE : EXB, TEXTURE BLK, EXW, ZP, DUROSIL, HSG

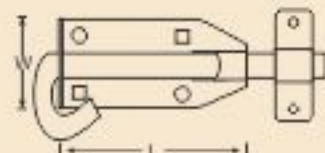

1257 : MILD STEEL SLIDING ACTION BOLT (DOUBLE LOCKING)

TECHNICAL DATA

ITEM CODE	SIZE	SHOOT LENGTH	LENGTH	WIDTH	THICKNESS	BOLT	SHOOT DIA	WT/ PCS	PCS. IN INNER	PCS. IN OUTER	PCS. IN PALLET
MIRN1257100	4"	186	104	72	2.0	M6	9.0	0.283	10	80	2400

FINISH AVAILABLE : EXB, TEXTURE BLK, EXW, ZP, DUROSIL, HSG

2ASA : MILD STEEL MEDIUM PADBOLT

TECHNICAL DATA

ITEM CODE	SIZE	SHOOT LENGTH	LENGTH	WIDTH	THICKNESS	BOLT	SHOOT DIA	WT/ PCS	PCS. IN INNER	PCS. IN OUTER	PCS. IN PALLET
MIRN2ASA100	4"	105	114	52	1.6	M6	12	0.230	5	40	1920
MIRN2ASA150	6"	156	170	52	1.6	M6	12	0.317	5	35	1575
MIRN2ASA200	8"	203	214	52	1.6	M6	12	0.404	5	25	1125
MIRN2ASA250	10"	255	265	52	1.6	M6	12	0.491	5	20	900
MIRN2ASA300	12"	300	315	52	1.6	M6	12	0.571	5	20	720

FINISH AVAILABLE : EXB, TEXTURE BLK, EXW, ZP, DUROSIL, HSG

SPARES : MILD STEEL KEEPS FOR PADBOLT
TECHNICAL DATA

ITEM CODE	LENGTH	WIDTH	THICKNESS	BOLT	WT/PCS	PCS. IN INNER	PCS. IN OUTER
1A	58	38	1.9	M6	0.057	50	800
2A	50	35	1.1	M6	0.017	50	800
2ASA	58	26	1.6	M6	0.024	50	500
4A, 4ASA	83	23	2.2	M6	0.044	25	400
6A	63	21	1.9	M6	0.024	50	500
1AEK	91	40	2.5	M6	0.098	20	200
2AEK	80	20	2.0	M6	0.035	20	200

FINISH AVAILABLE : EXB, TEXTURE BLK, EXW, ZP, DUROSIL, HSG

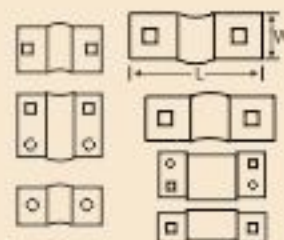

60BHB : MILD STEEL BOW HANDLE BOLT

TECHNICAL DATA

ITEM CODE	SIZE	LENGTH	WIDTH	THICKNESS	SHOOT SQUARE	SCREW NO.	WT/ PCS	PCS. IN INNER	PCS. IN OUTER	PCS. IN PALLET
MIRN60BH300	12"	305	50	2.0	16	10	0.864	2	20	560
MIRN60BH375	15"	380	50	2.0	16	10	0.927	2	20	480
MIRN60BH450	18"	458	50	2.0	16	10	1.081	2	16	192
MIRN60BH600	24"	610	50	2.0	16	10	1.215	2	12	168
MIRN60BH750	30"	762	50	2.0	16	10	1.349	2	12	240
MIRN60BH900	36"	915	50	2.0	16	10	1.483	2	12	240

FINISH AVAILABLE : EXB, TEXTURE BLK, EXW, ZP, DUROSIL, HSG

60MTB : MILD STEEL MONKEY TAIL BOLT

TECHNICAL DATA

ITEM CODE	SIZE	LENGTH	WIDTH	THICKNESS	SHOOT SQUARE	SCREW NO.	WT/ PCS	PCS. IN INNER	PCS. IN OUTER	PCS. IN PALLET
MIRN60MT300	12"	320	50	2.0	16	10	0.782	2	24	672
MIRN60MT375	15"	385	50	2.0	16	10	0.835	2	22	440
MIRN60MT450	18"	458	50	2.0	16	10	0.977	2	20	400
MIRN60MT600	24"	605	50	2.0	16	10	1.111	2	12	240
MIRN60MT750	30"	765	50	2.0	16	10	1.242	2	12	240
MIRN60MT900	36"	916	50	2.0	16	10	1.369	2	10	200

FINISH AVAILABLE : EXB, TEXTURE BLK, EXW, ZP, DUROSIL, HSG

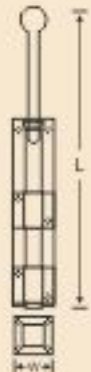
66 : MILD STEEL CHAIN BOLT REVERSIBLE SPRING LOADED SHOOT

TECHNICAL DATA

ITEM CODE	SIZE	SHOOT LENGTH	LENGTH	WIDTH	SHOOT SQUARE	CHAIN LENGTH	SCREW NO.	WT/ PCS	PCS. IN INNER	PCS. IN OUTER	PCS. IN PALLET
MSCF0066210	8"	206	189	50	16	18"	10	0.585	5	30	1350

FINISH AVAILABLE : EXB, TEXTURE BLK, EXW, ZP, DUROSIL, HSG



68 : MILD STEEL FOOTBOLT

TECHNICAL DATA

ITEM CODE	SIZE	LENGTH	WIDTH	SHOOT SQUARE	SHOOT LENGTH	THICKNESS	SCREW NO.	WT/ PCS	PCS. IN INNER	PCS. IN OUTER	PCS. IN PALLET
MIRN0068175	8"	186	50	15	205	2.0	10	0.850	5	25	1050

FINISH AVAILABLE : EXB, TEXTURE BLK, EXW, ZP, DUROSIL, HSG

482-83-84-85 : MILD STEEL ACCESSORIES FOR BOLTS (TO SUIT 16MM BOLTS)

484



482

TECHNICAL DATA

ITEM CODE	LENGTH	WIDTH	THICKNESS	SCREW NO.	WT/ PCS	PCS. IN INNER	PCS. IN OUTER	PCS. IN PALLET
MIRN0482016	45	48	5.5	8	0.207	50	100	3000
MIRN0483016	50	50	2.0	8	0.033	50	500	20000
MIRN0484016	64	37	1.2	8	0.029	50	500	20000
MIRN0485016	70	50	3.0	8	0.072	50	250	10000

FINISH AVAILABLE : EXB, TEXTURE BLK, EXW, ZP, DUROSIL, HSG

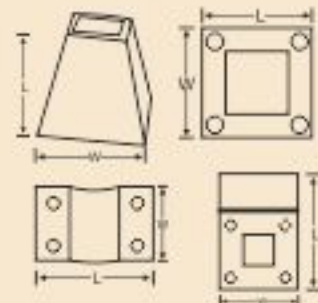

485



483

1259 : MILD STEEL DOOR BOLT

TECHNICAL DATA

ITEM CODE	SIZE	LENGTH	WIDTH	THICKNESS	SHOOT LENGTH	SHOOT DIA	SCREW NO.	WT/ PCS	PCS. IN INNER	PCS. IN OUTER	PCS. IN PALLET
MIRN1259150	6"	158	25	2.0	130	8.0	7	0.170	10	100	3600
MIRN1259200	8"	200	32	2.0	180	12.5	7	0.418	10	30	1800
MIRN1259250	10"	252	32	2.0	225	12.5	7	0.470	10	40	1440
MIRN1259300	12"	305	32	2.0	275	12.5	7	0.586	10	30	1260

FINISH AVAILABLE : EXB, TEXTURE BLK, EXW, ZP, DUROSIL, HSG



1260L : MILD STEEL LIGHT GARAGE DOOR BOLT WITH RECEIVER PLATE

TECHNICAL DATA

ITEM CODE	SIZE	LENGTH	SCREW NO.	THICKNESS	BOLT DIA	WT/ PCS	PCS. IN INNER	PCS. IN OUTER	PCS. IN PALLET
MIRN1260300	12"	310	8	3.0	16	1.003	2	20	600
MIRN1260375	15"	390	8	3.0	16	1.126	2	20	480
MIRN1260450	18"	465	8	3.0	16	1.250	2	16	480
MIRN1260600	24"	617	8	3.0	16	1.580	2	16	320
MIRN1260750	30"	770	10	3.0	16	1.825	2	12	288
MIRN1260900	36"	922	10	3.0	16	2.065	2	8	160

FINISH AVAILABLE : EXB, TEXTURE BLK, EXW, ZP, DUROSIL, HSG

1260H : MILD STEEL HEAVY GARAGE DOOR BOLT WITH RECEIVER PLATE

TECHNICAL DATA

ITEM CODE	SIZE	LENGTH	SCREW NO.	THICKNESS	BOLT DIA	WT/ PCS	PCS. IN INNER	PCS. IN OUTER	PCS. IN PALLET
MIRN1160300	12"	310	8	4.0	16	1.602	2	20	600
MIRN1160450	18"	465	8	4.0	16	1.847	2	16	384
MIRN1160600	24"	617	8	4.0	16	2.085	2	12	240

FINISH AVAILABLE : EXB, TEXTURE BLK, EXW, ZP, DUROSIL, HSG

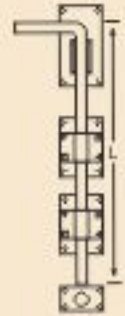
1260HLK : MILD STEEL LOCKING GARAGE DOOR BOLT

TECHNICAL DATA

ITEM CODE	SIZE	LENGTH	WIDTH	THICKNESS	SCREW NO.	WT/ PCS	PCS. IN INNER	PCS. IN OUTER	PCS. IN PALLET
MIRN9971450	18"	455	140	4.0	8&12	1.940	2	4	288

FINISH AVAILABLE : EXB, TEXTURE BLK, EXW, ZP, DUROSIL, HSG

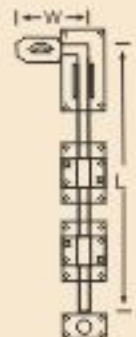

597 : MILD STEEL CROSS DOOR BOLT

TECHNICAL DATA

ITEM CODE	SIZE	LENGTH	WIDTH	SECTION THICKNESS	SCREW NO.	SHOOT DIA	WT/PCS	PCS. IN INNER	PCS. IN OUTER	PCS. IN PALLET
MIRN0597300	12"	316	64	4.0	8	16	1,936	2	8	400
MIRN0597450	18"	465	64	4.0	8	16	2,640	2	8	340
MIRN0597600	24"	616	64	4.0	8	16	3,000	2	8	160

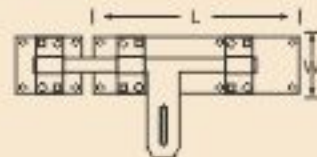

FINISH AVAILABLE : EXB, TEXTURE BLK, EXW, ZP, DUROSIL, HSG

213 : MILD STEEL CANE BOLT

TECHNICAL DATA

ITEM CODE	SIZE	LENGTH	WIDTH	SHOOT DIA	SCREW NO.	WT/PCS	PCS. IN INNER	PCS. IN OUTER
MGF00213300	12"	306	75	12.0	10	0.494	2	2

FINISH AVAILABLE : EXB, TEXTURE BLK, EXW, ZP, DUROSIL, HSG

7A : MILD STEEL AUTO LOCK PIG BOLT

TECHNICAL DATA

ITEM CODE	SIZE	LENGTH	WIDTH	THICKNESS	SHOOT DIA	WT/PCS	SCREW NO.	PCS. IN INNER	PCS. IN OUTER
MGF007A200	8"	215	50	2.1	14.0	0.668	8	5	20

FINISH AVAILABLE : EXB, TEXTURE BLK, EXW, ZP, DUROSIL, HSG

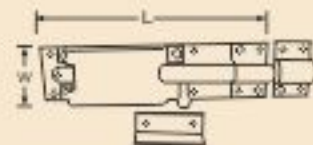

1836 : MILD STEEL SPRING LOADED ANIMAL BOLT

TECHNICAL DATA

ITEM CODE	SIZE	LENGTH	WIDTH	SECTION THICKNESS	SCREW NO.	SHOOT DIA	WT/ PCS	PCS. IN INNER	PCS. IN OUTER	PCS. IN PALLET
MGF1836010	3/8"	143	40	3.0	10	10	0.330	5	50	2500
MGF1836012	1/2"	225	40	4.0	10	12	0.572	5	30	1200
MGF1836016	5/8"	242	50	5.0	10	16	1.042	5	15	720

FINISH AVAILABLE : EXB, TEXTURE BLK, EXW, ZP, DUROSIL, HSG

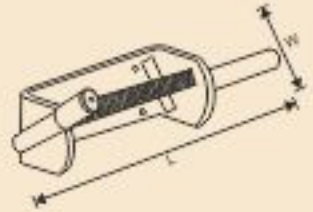
1835 : MILD STEEL SPRING LOADED ANIMAL BOLT C/W STAPLE

TECHNICAL DATA

ITEM CODE	SIZE	LENGTH	WIDTH	THICKNESS	SCREW NO.	SHOOT DIA	WT/ PCS	PCS. IN INNER	PCS. IN OUTER	PCS. IN PALLET
MGR1835010	3/8"	143	40	3.0	10	10	0.486	5	40	1600
MGR1835012	1/2"	225	40	4.0	10	12	0.728	5	30	720
MGR1835016	5/8"	242	50	5.0	10	16	1.239	5	15	540

FINISH AVAILABLE : EXB, TEXTURE BLK, EXW, ZP, DUROSIL, HSG

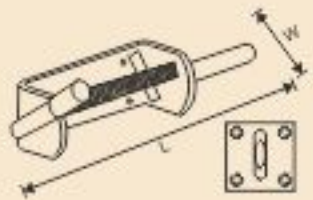
BRASS FLUSH BOLT

TECHNICAL DATA

DPG CODE	ITEM CODE	LENGTH	WIDTH	SCREW NO.	WT./PCS	PCS. IN INNER	PCS. IN OUTER
GB3100	BMIH3100150	153	19	6	0.145	10	100
GB3101	BMIH3101200	205	19	6	0.178	10	100

FINISH AVAILABLE : POLISHED & LACQUERED BRASS/CP/SNP

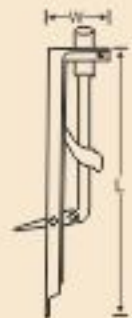

ALUMINIUM FLUSH BOLT

TECHNICAL DATA

DPG CODE	ITEM CODE	LENGTH	WIDTH	SCREW NO.	WT./PCS	PCS. IN INNER	PCS. IN OUTER
GA1671	AMH1671150	150	19	6	0.065	10	100
GA1672	AMH1672200	201	19	6	0.085	10	100

FINISH AVAILABLE : SAA

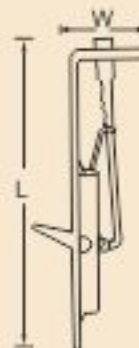
1819 : MILD STEEL AUTOMATIC GATE CATCH STEEL CASE & PEG

TECHNICAL DATA

ITEM CODE	SIZE	LENGTH	WIDTH	THICK.	SCREW NO.	PEG DIA LENGTH	WT/ SET	SET. IN INNER	SET. IN OUTER	SET. IN PALLET
MGR1619050	2"	51	45	1.4	6	8.5x114	0.163	10	140	3780

FINISH AVAILABLE : EXB, TEXTURE BLK, EXW, ZP, DUROSIL, HSG

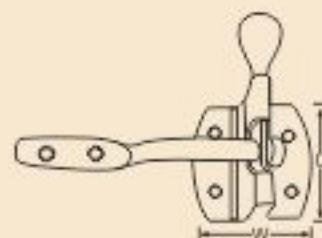
1619 : MILD STEEL AUTOMATIC GATE CATCH STEEL CASE & PEG (ECO)

TECHNICAL DATA

ITEM CODE	SIZE	LENGTH	WIDTH	THICK.	SCREW NO.	PEG DIA LENGTH	WT/ SET	SET. IN INNER	SET. IN OUTER	SET. IN PALLET
MIRN1619050	2"	51	42	1.4	6	8X123	0.144	10	140	3780

FINISH AVAILABLE : EXB, TEXTURE BLK, EXW, ZP, DUROSIL, HSG

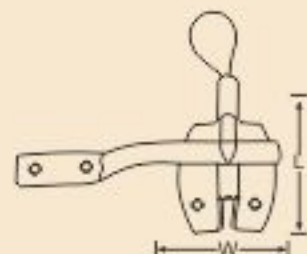

1819AH : MILD STEEL AUTOMATIC GATE CATCH STEEL CASE & PEG (SA PATTERN)

TECHNICAL DATA

ITEM CODE	SIZE	LENGTH	WIDTH	THICK.	SCREW NO.	PEG DIA LENGTH	WT/ SET	SET. IN INNER	SET. IN OUTER	SET. IN PALLET
MGF1818050	1.5"	40	40	1.9	6	9.5x116	0.140	10	140	3780

FINISH AVAILABLE : EXB, TEXTURE BLK, EXW, ZP, DUROSIL, HSG

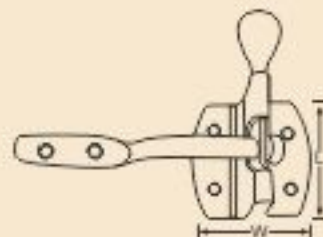
1819B : MILD STEEL AUTOMATIC GATE CATCH STEEL CASE & PEG

TECHNICAL DATA

ITEM CODE	SIZE	LENGTH	WIDTH	THICK.	SCREW NO.	PEG DIA LENGTH	WT/ SET	SET. IN INNER	SET. IN OUTER	SET. IN PALLET
MGF1719050	2"	45	41	2.7	6	8.5x115	0.170	10	140	3780

FINISH AVAILABLE : EXB, TEXTURE BLK, EXW, ZP, DUROSIL, HSG

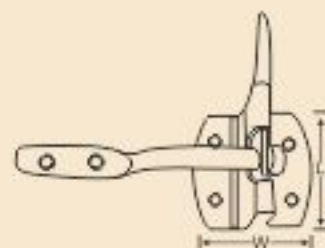
1822 : MILD STEEL HEAVY AUTOMATIC GATE CATCH STEEL CASE, IRON PEG

TECHNICAL DATA

ITEM CODE	SIZE	LENGTH	WIDTH	THICK.	SCREW NO.	PEG DIA LENGTH	WT/ SET	SET. IN INNER	SET. IN OUTER	SET. IN PALLET
MGF1822050	2"	57	56	2.6	6	11x125	0.313	10	60	1800

FINISH AVAILABLE : EXB, TEXTURE BLK, EXW, ZP, DUROSIL, HSG



1622 : MILD STEEL HEAVY AUTOMATIC GATE CATCHES STEEL CASE, CAST PEG (ECO)

TECHNICAL DATA

ITEM CODE	SIZE	LENGTH	WIDTH	THICK.	SCREW NO.	PEG DIA & LENGTH	WT/ SET	SET. IN INNER	SET. IN OUTER	SET. IN PALLET
MIRN1622050	2"	57	56	2.0	6	8X116	0.300	10	60	1800

FINISH AVAILABLE : EXB, TEXTURE BLK, EXW, ZP, DUROSIL, HSG

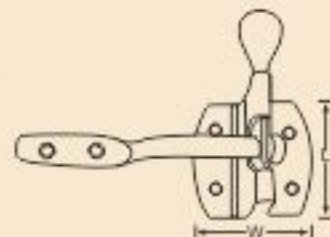
PEGS FOR AUTOMATIC GATE CATCHES

TECHNICAL DATA

DPG CODE	ITEM CODE	LENGTH	WIDTH	SCREW NO.	PEG DIA	WT./PCS	PCS. IN INNER	PCS. IN OUTER
1819P	MMH1819115 (P1)	114	15	8	9	0.053	20	200
1822P	MMH1822XXX (P2)	116	22	12	9	0.115	20	100
1823P	MIRN1823125 (P3)	125	19	12	11	0.100	20	100
1620P	MIRN1620115 (P4)	116	15	8	9	0.063	20	200

FINISH AVAILABLE : EXB, TEXTURE BLK, EXW, ZP, DUROSIL, HSG

20 : MILD STEEL SUFFOLK LATCH

TECHNICAL DATA

DPG CODE	ITEM CODE	SIZE	LENGTH	WIDTH	THICKNESS	SCREW NO.	WT/ SET	SET. IN INNER	SET. IN OUTER	SET. IN PALLET
20	MIRN0020175	7"	179	45	1.5	6	0.380	5	50	800
20	MIRN0020190	7.5"	191	45	1.5	6	0.400	5	50	800
20	MIRN0020200	8"	205	45	1.5	6	0.400	5	50	800
20	MIRN0050230	9"	230	45	1.5	6	0.415	5	50	800

FINISH AVAILABLE : EXB, TEXTURE BLK, EXW, ZP, DUROSIL, HSG



20L : MILD STEEL SUFFOLK LATCH (ECO)

TECHNICAL DATA

ITEM CODE	SIZE	LENGTH	WIDTH	THICKNESS	SCREW NO.	WT/ SET	SET. IN INNER	SET. IN OUTER	SET. IN PALLET
MIRN020L175	7"	179	45	1.5	6	0.330	5	50	800
MIRN020L190	7.5"	191	45	1.5	6	0.350	5	50	800
MIRN020L200	8"	205	45	1.5	6	0.360	5	50	800
MIRN020L230	9"	230	45	1.5	6	0.365	5	50	800

FINISH AVAILABLE : EXB, TEXTURE BLK, EXW, ZP, DUROSIL, HSG

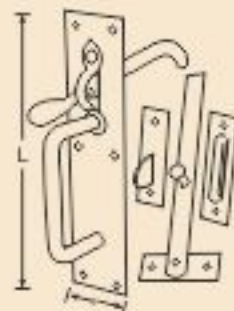
50/4: MILD STEEL SUFFOLK LATCH HEAVY

TECHNICAL DATA

ITEM CODE	SIZE	LENGTH	WIDTH	THICKNESS	SCREW NO.	WT/ SET	SET. IN INNER	SET. IN OUTER	SET. IN PALLET
MIRN020H175	7"	179	45	2.0	6	0.412	5	50	800
MIRN020H190	7.5"	191	45	2.0	6	0.418	5	50	800
MIRN020H200	8"	205	45	2.0	6	0.436	5	50	800
MIRN020H230	9"	230	45	2.0	6	0.483	5	50	800

FINISH AVAILABLE : EXB, TEXTURE BLK, EXW, ZP, DUROSIL, HSG

20P : MILD STEEL SUFFOLK LATCH PREMIUM RANGE

TECHNICAL DATA

ITEM CODE	SIZE	LENGTH	WIDTH	THICKNESS	SCREW NO.	WT/ SET	SET. IN INNER	SET. IN OUTER	SET. IN PALLET
MIRN020P230	9"	220	50	2.2	8	0.645	5	50	800

FINISH AVAILABLE : EXB, TEXTURE BLK, EXW, ZP, DUROSIL, HSG



SPARES : MILD STEEL FOR 20/2 SUFFOLK LATCH (KEEP, CATCH & T BAR)

TECHNICAL DATA

ITEM CODE	LENGTH	WIDTH	THICKNESS	SCREW NO.	WT/PCS	PCS. IN INNER	PCS. IN OUTER
MMIH020CXXX(A)	74	22	1.5	6	0.025	50	500
MMIH020LXXX(B)	192	65	1.5	6	0.087	20	200
MMIH020KXXX(C)	87	25	1.5	6	0.025	50	500

FINISH AVAILABLE : EXB, TEXTURE BLK, EXW, ZP, DUROSIL, HSG

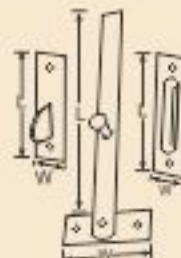
BLACK ANTIQUE THUMB LATCH SET

TECHNICAL DATA

DPG CODE	ITEM CODE	LENGTH	WIDTH	SCREW NO.	WT/ SET	SET. IN INNER	SET. IN OUTER	SET. IN PALLET
G0350	CMIH0350200	140	192	8	0.590	5	30	1200
G0801	CIRN0801200	155	197	7	0.620	5	30	1200

FINISH AVAILABLE : EXB, DUROSIL, PEWTER

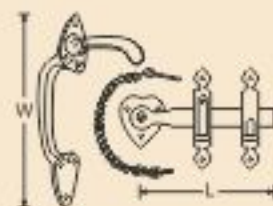
1136 : MILD STEEL GATE LATCH PLAIN RING HANDLE

TECHNICAL DATA

ITEM CODE	SIZE	LENGTH	WIDTH	THICKNESS	SCREW NO.	WT/ SET	SET. IN INNER	SET. IN OUTER	SET. IN PALLET
MIRN1136127	5"	127	25	4.0	6	0.522	5	40	1440
MIRN1136150	6"	152	25	4.0	6	0.540	5	30	1170
MIRN1136178	7"	178	25	4.0	6	0.562	5	30	1170

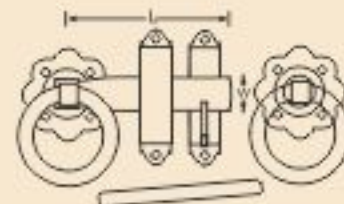
 FINISH AVAILABLE : EXB, TEXTURE BLK, EXW, ZP, DUROSIL, HSG
 RING DIA (70MM X 8MM), SPINDLE (8MM X 100MM)

1136L : MILD STEEL GATE LATCH PLAIN RING HANDLE (ECO)
TECHNICAL DATA

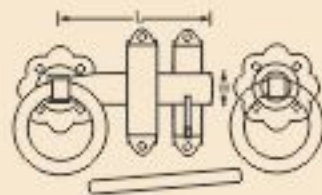

ITEM CODE	SIZE	LENGTH	WIDTH	THICKNESS	SCREW NO.	WT./SET	SET IN. INNER	SET IN. OUTER	SET IN. PALLET
MIRN1140127	5"	127	25	3.5	6	0.461	5	40	1440
MIRN1140150	6"	152	25	3.5	6	0.483	5	30	1170
MIRN1140178	7"	178	25	3.5	6	0.494	5	30	1170



FINISH AVAILABLE: EXB, TEXTURE BLK, EXW, ZP, DUROSIL, HSG
RING DIA (70MM X 7MM), SPINDLE (6MM X 100MM)

1136BR : MILD STEEL GATE LATCH PLAIN BIG RING HANDLE
TECHNICAL DATA

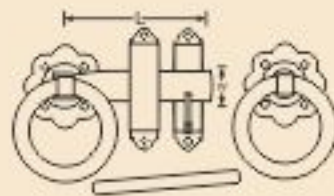

ITEM CODE	SIZE	LENGTH	WIDTH	THICKNESS	SCREW NO.	WT./PCS	PCS. IN INNER	PCS. IN OUTER	PCS. IN PALLET
MIRN1137127	5"	127	25	4.0	6	0.565	5	35	1260
MIRN1137150	6"	152	25	4.0	6	0.567	5	30	1170
MIRN1137178	7"	178	25	4.0	6	0.569	5	30	1170



FINISH AVAILABLE : EXB, TEXTURE BLK, EXW, ZP, DUROSIL, HSG
NOTE : ALSO AVAILABLE 1136BR PREMIUM
RING DIA (85MM X 8MM), SPINDLE (6MM X 100MM)

1136EH : MILD STEEL EXTRA HEAVY GATE LATCH PLAIN RING HANDLE
TECHNICAL DATA

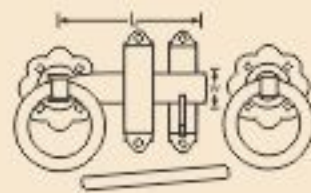
ITEM CODE	SIZE	LENGTH	WIDTH	THICKNESS	SCREW NO.	WT./PCS	PCS. IN INNER	PCS. IN OUTER	PCS. IN PALLET
MIRN1138127	5"	127	25	4.0	6	0.639	5	35	1260
MIRN1138150	6"	152	25	4.0	6	0.642	5	30	1170
MIRN1138178	7"	178	25	4.0	6	0.645	5	30	1170



FINISH AVAILABLE : EXB, TEXTURE BLK, EXW, ZP, DUROSIL, HSG
RING DIA (70MM X 8MM), SPINDLE (8MM X 100MM)

1141 : MILD STEEL GATE LATCH TWISTED RING HANDLE

TECHNICAL DATA

ITEM CODE	SIZE	LENGTH	WIDTH	THICKNESS	SCREW NO.	WT/ SET	SET. IN INNER	SET. IN OUTER	SET. IN PALLET
MIRN1141127	5"	127	25	4.0	6	0.522	5	40	1440
MIRN1141150	6"	152	25	4.0	6	0.540	5	30	1170
MIRN1141178	7"	178	25	4.0	6	0.562	5	30	1170

FINISH AVAILABLE : EXB, TEXTURE BLK, EXW, ZP, DUROSIL, HSG
SPINDLE (8MM X 100MM)

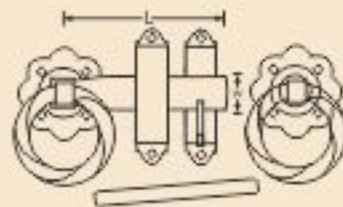
1136A : MILD STEEL WENDY HOUSE LATCH

TECHNICAL DATA

ITEM CODE	SIZE	LENGTH	WIDTH	THICKNESS	SCREW NO.	WT/ SET	SET. IN INNER	SET. IN OUTER	SET. IN PALLET
MIRN1135100	4"	101	25	3.2	6	0.411	5	40	1280

FINISH AVAILABLE : EXB, TEXTURE BLK, EXW, ZP, DUROSIL, HSG

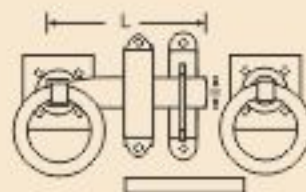
SPARES : MILD STEEL RING ONLY

136 137 138



139 140

TECHNICAL DATA

ITEM CODE	ROSE DIA	RING DIA	RING WIRE DIA	SCREW NO.	WT./PCS	PCS. IN INNER	PCS. IN OUTER	PCS. IN PALLET
MIRN0137055	66	85	8.0	6	0.170	10	100	3600
MIRN0136055	66	70	8.0	6	0.145	10	100	3600
MIRN0138060	60	70	8.0	6	0.145	10	100	3600
MIRN0139060	60	85	8.0	6	0.171	10	100	3600
MIRN0140050	52	58	8.0	6	0.121	10	100	3600

FINISH AVAILABLE : EXB, TEXTURE BLK, EXW, ZP, DUROSIL, HSG
NOTE : ALSO AVAILABLE 141 (TWISTED) RING HANDLE.

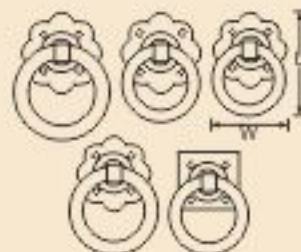

BLACK ANTIQUE RING GATE LATCH TWISTED (HEAVY SQUARE PATTERN)

TECHNICAL DATA

DPG CODE	ITEM CODE	LENGTH	WIDTH	SCREW NO.	WT./SET	SET. IN INNER	SET. IN OUTER
G2255	GIRN2255180	180	64X64	7	0.965	5	20

FINISH AVAILABLE : EXB, EXW, DUROSIL, PEWTER

SPARES : MILD STEEL KEEP & CATCH FOR RING GATE LATCH

R1

R2

TECHNICAL DATA

ITEM CODE	LENGTH	WIDTH	THICKNESS	SCREW NO.	WT./PCS	PCS. IN INNER	PCS. IN OUTER	PCS. IN PALLET
MIRN136CXX/R1	80	20	1.7	8	0.042	50	400	14400
MIRN136CXX/R2	79	20	2.0	8	0.045	50	400	14400

FINISH AVAILABLE : EXB, TEXTURE BLK, EXW, ZP, DUROSIL, HSG



1131 : MILD STEEL SURFACE LATCH

TECHNICAL DATA

ITEM CODE	SIZE	WIDTH	SCREW NO.	WT./PCS	PCS. IN INNER	PCS. IN OUTER
MIRN1131175	7"	56	8	0.265	10	60

FINISH AVAILABLE : EXB, TEXTURE BLK, EXW, ZP, DUROSIL, HSG

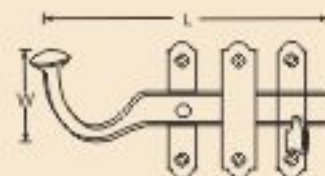
NOTE : LEFT & RIGHT BOTH AVAILABLE



1261SS : STAINLESS STEEL CABIN HOOK
TECHNICAL DATA

ITEM CODE	SIZE	LENGTH	ROAD DIA	THICKNESS	SCREW NO.	WT./PCS	PCS. IN INNER	PCS. IN OUTER	PCS. IN PALLET
SIRN1261065	2.5"	65	3.8	1.7	6	0.023	20	400	11200
SIRN1261075	3"	75	3.8	1.7	6	0.025	20	400	11200
SIRN1261100	4"	100	5.6	1.7	6	0.043	20	400	11200
SIRN1261125	5"	125	5.6	1.7	6	0.047	20	300	10800
SIRN1261150	6"	150	5.6	1.7	6	0.052	20	300	10800
SIRN1261200	8"	200	5.6	1.7	6	0.061	20	300	9000



FINISH AVAILABLE : SATIN, MIRROR

1261 : MILD STEEL WIRE CABIN HOOK
TECHNICAL DATA

ITEM CODE	SIZE	LENGTH	WIDTH	WIRE DIA	THICKNESS	SCREW NO.	WT./PCS	PCS. IN INNER	PCS. IN OUTER	PCS. IN PALLET
MIRN1261075	3"	76	40	6.25	2.0	6	0.095	20	240	7200
MIRN1261100	4"	101	40	6.25	2.0	6	0.104	20	200	6000
MIRN1261150	6"	152	40	6.25	2.0	6	0.115	10	200	6000
MIRN1261200	8"	200	40	7.5	2.0	6	0.169	10	120	4320
MIRN1261250	10"	250	40	7.5	2.0	6	0.193	10	100	3600
MIRN1261300	12"	300	40	7.5	2.0	6	0.219	10	100	2400

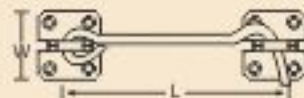

FINISH AVAILABLE : EXB, TEXTURE BLK, EXW, ZP, DUROSIL, HSG

1262 : MILD STEEL EXTRA LONG CABIN HOOK
TECHNICAL DATA

ITEM CODE	SIZE	LENGTH	WIDTH	WIRE DIA	THICKNESS	SCREW NO.	WT./PCS	PCS. IN INNER	PCS. IN OUTER	PCS. IN PALLET
MIRN1262150	6"	160	42	5.8	1.8	6	0.052	20	300	9600
MIRN1262200	8"	210	42	5.8	1.8	6	0.063	20	200	8000
MIRN1262250	10"	260	42	5.6	1.8	6	0.075	20	200	7200
MIRN1262300	12"	310	42	5.6	1.8	6	0.088	20	240	5700
MIRN1262350	14"	350	42	5.6	1.8	6	0.095	20	160	3840
MIRN1262375	15"	375	42	5.6	1.8	6	0.100	20	120	3240
MIRN1262450	18"	460	42	5.6	1.8	6	0.132	20	120	2400



FINISH AVAILABLE : EXB, TEXTURE BLK, EXW, ZP, DUROSIL, HSG

1264: MILD STEEL CABIN HOOK
TECHNICAL DATA

ITEM CODE	SIZE	LENGTH	WIDTH	WIRE DIA	THICKNESS	SCREW NO.	WT./PCS	PCS. IN INNER	PCS. IN OUTER	PCS. IN PALLET
MIRN1264400	16"	410	57	12	2	8	0.547	5	20	800
MIRN1264450	18"	455	57	12	2	8	0.570	5	20	720
MIRN1264500	20"	520	57	12	2	8	0.637	5	20	640
MIRN1264600	24"	605	57	12	2	8	0.126	5	20	540

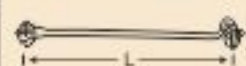

FINISH AVAILABLE : EXB, TEXTURE BLK, EXW, ZP, DUROSIL, HSG

BRASS VICTORIAN CABIN HOOK
TECHNICAL DATA

DPG CODE	ITEM CODE	LENGTH	WIDTH	SCREW NO.	WT/ PCS	PCS. IN INNER	PCS. IN OUTER	PCS. IN PALLET
GB2601	BMH2601075	98	35	6	0.090	10	200	4500
GB2602	BMH2602100	115	35	6	0.088	10	200	4500
GB2603	BMH2603150	160	35	6	0.100	10	160	4800
GB2604	BMH2604200	215	35	6	0.140	10	140	4200



FINISH AVAILABLE : POLISHED & LACQUERED BRASS/CP/SNP

BRASS VICTORIAN HEAVY CABIN HOOK
TECHNICAL DATA

DPG CODE	ITEM CODE	LENGTH	WIDTH	SCREW NO.	WT/ PCS	PCS. IN INNER	PCS. IN OUTER	PCS. IN PALLET
GB2612	BMH2612150	175	39	6	0.163	10	100	3600
GB2613	BMH2613200	220	39	6	0.189	10	100	3600
GB2614	BMH2614250	265	42	6	0.260	5	60	2040
GB2615	BMH2615300	320	42	6	0.325	5	40	1560

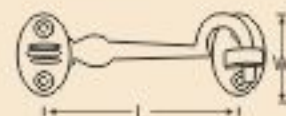

FINISH AVAILABLE : POLISHED & LACQUERED BRASS/CP/SNP

BLACK ANTIQUE CABIN HOOK SQUARE CAST PLATE

TECHNICAL DATA

DPG CODE	ITEM CODE	LENGTH	WIDTH	SCREW NO.	WT/PCS	PCS. IN INNER	PCS. IN OUTER	PCS. IN PALLET
G0420	CMH0420100	105	54	8	0.193	10	100	4500
G0421	CMH0421150	155	54	8	0.202	10	80	3520

FINISH AVAILABLE : EXB, DUROSIL, HSG, PEWTER

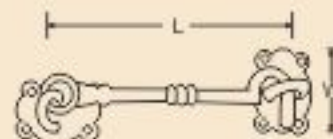
BLACK ANTIQUE CABIN HOOK OVAL PLATE

TECHNICAL DATA

DPG CODE	ITEM CODE	LENGTH	WIDTH	SCREW NO.	WT/PCS	PCS. IN INNER	PCS. IN OUTER	PCS. IN PALLET
G2099	CIRN2099075	75	45	8	0.102	20	100	5000
G2100	CIRN2100100	102	45	8	0.126	20	100	5000
G2101	CIRN2101150	152	45	8	0.140	10	120	4320
G2102	CIRN2102200	203	45	8	0.224	10	80	3200
G2103	CIRN2103250	255	45	8	0.236	10	80	3120
G2104	CIRN2104300	305	45	8	0.274	10	60	2100

FINISH AVAILABLE : EXB, DUROSIL, HSG, PEWTER

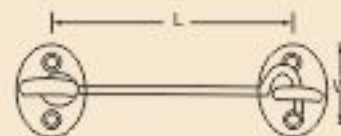
BLACK ANTIQUE CABIN HOOK OVAL PLATE WITH RING

TECHNICAL DATA

DPG CODE	ITEM CODE	LENGTH	WIDTH	SCREW NO.	WT/PCS	PCS. IN INNER	PCS. IN OUTER	PCS. IN PALLET
G2099A	CIRN3099075	85	45	8	0.104	20	100	5000
G2100A	CIRN3100100	106	45	8	0.120	20	100	5000
G2101A	CIRN3101150	155	45	8	0.142	10	120	4320
G2102A	CIRN3102200	210	45	8	0.205	10	80	3200
G2103A	CIRN3103250	255	45	8	0.226	10	80	3120
G2104A	CIRN3104300	310	45	8	0.330	10	60	2100

FINISH AVAILABLE : EXB, DUROSIL, HSG, PEWTER

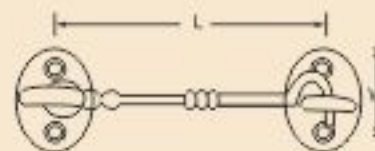

149M : MILD STEEL SAFETY HASP AND STAPLE (MEDIUM WEIGHT LOCKING BAR)

TECHNICAL DATA

ITEM CODE	SIZE	LENGTH	WIDTH	THICKNESS	SCREW NO.	BOLT NO	WT/ PCS	PCS. IN INNER	PCS. IN OUTER	PCS. IN PALLET
MIRN149M200	8"	201	45	3.5	12	M8	0.395	5	40	1920
MIRN149M250	10"	250	54	4.0	12	M10	0.614	5	35	1200



FINISH AVAILABLE : EXB, TEXTURE BLK, EXW, ZP, DUROSIL, HSG

147 : MILD STEEL SWIVEL LOCKING BAR

TECHNICAL DATA

ITEM CODE	SIZE	LENGTH	WIDTH	THICKNESS	SCREW NO.	WT/ PCS	PCS. IN INNER	PCS. IN OUTER	PCS. IN PALLET
MIRN0147200	8"	203	54	4.0	12	0.693	5	25	1000
MIRN0147250	10"	251	54	4.0	12	0.790	5	25	1000
MIRN0147300	12"	307	54	4.0	12	0.870	5	20	800

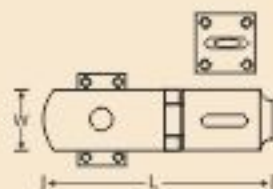

FINISH AVAILABLE : EXB, TEXTURE BLK, EXW, ZP, DUROSIL, HSG

146 : MILD STEEL VERTICAL HASP AND STAPLE

TECHNICAL DATA

ITEM CODE	SIZE	LENGTH	WIDTH	THICKNESS	SCREW NO.	BOLT NO	WT/ PCS	PCS. IN INNER	PCS. IN OUTER	PCS. IN PALLET
MIRN0146150	6"	150	54	4.6	12	M10	0.651	5	25	1000

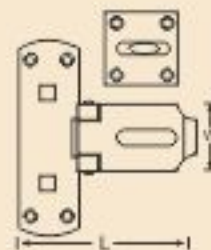

FINISH AVAILABLE : EXB, TEXTURE BLK, EXW, ZP, DUROSIL, HSG

617 : MILD STEEL SAFETY HASP AND STAPLE
TECHNICAL DATA

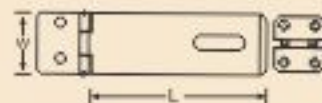

ITEM CODE	SIZE	LENGTH	WIDTH	THICKNESS	SCREW NO.	WT/ PCS	PCS. IN INNER	PCS. IN OUTER	PCS. IN PALLET
MIRN0617075	3"	76	38	2.0	8	0.090	10	240	9600
MIRN0617090	3.5"	90	38	2.0	8	0.104	10	160	6400
MIRN0617114	4.5"	114	38	2.0	8	0.142	10	160	6400
MIRN0617150	6"	152	38	2.0	8	0.160	10	120	4800



FINISH AVAILABLE : EXB, TEXTURE BLK, EXW, ZP, DUROSIL, HSG

617L : MILD STEEL SAFETY HASP AND STAPLE (ECO)
TECHNICAL DATA

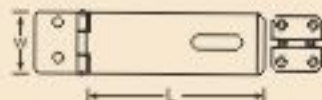
ITEM CODE	SIZE	LENGTH	WIDTH	THICKNESS	SCREW NO.	WT/ PCS	PCS. IN INNER	PCS. IN OUTER	PCS. IN PALLET
MIRN617L075	3"	76	34	1.6	8	0.075	10	240	9600
MIRN617L100	3.5"	90	34	1.6	8	0.090	10	160	6400
MIRN617L114	4.5"	114	34	1.6	8	0.106	10	160	6400
MIRN617L150	6"	152	34	1.6	8	0.120	10	120	4800



FINISH AVAILABLE : EXB, TEXTURE BLK, EXW, ZP, DUROSIL, HSG

617EL : MILD STEEL SAFETY HASP AND STAPLE (EXTRA LIGHT PATTERN)
TECHNICAL DATA

ITEM CODE	SIZE	LENGTH	WIDTH	THICKNESS	SCREW NO.	WT/ PCS	PCS. IN INNER	PCS. IN OUTER	PCS. IN PALLET
MIRN0618075	3"	75	22	1.5	5	0.030	25	500	22500
MIRN0618100	4"	100	30	1.0	4	0.038	25	500	22500



FINISH AVAILABLE : EXB, TEXTURE BLK, EXW, ZP, DUROSIL, HSG

149 : MILD STEEL SAFETY HASP AND STAPLE (HEAVY PATTERN)
TECHNICAL DATA

ITEM CODE	SIZE	LENGTH	WIDTH	THICKNESS	SCREW NO.	BOLT NO.	WT/ PCS	PCS. IN INNER	PCS. IN OUTER	PCS. IN PALLET
MIRND149150	6"	158	54	4	12	M10	0.457	5	40	1760
MIRND149200	8"	203	54	4	12	M8	0.550	5	40	1440
MIRND149250	10"	253	54	4	12	M10	0.635	5	35	1225
MIRND149300	12"	305	54	4	12	M10	0.725	5	30	900

FINISH AVAILABLE : EXB, TEXTURE BLK, EXW, ZP, DUROSIL, HSG
 * EXTRA HEAVY PATTERN

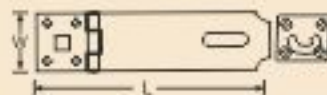
GLH001 : MILD STEEL LOCKING HASP AND STAPLE
TECHNICAL DATA

ITEM CODE	SIZE	LENGTH	WIDTH	THICKNESS	SCREW NO.	WT/ PCS	PCS. IN INNER	PCS. IN OUTER	PCS. IN PALLET
MSCF0001075	3"	78	32	1.5	5	0.110	10	100	2800
MSCF0001100	4"	115	32	1.5	5	0.120	10	100	2800

FINISH AVAILABLE : EXB, BZP, DUROSIL, CP

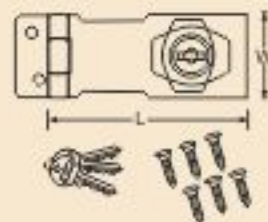
BRASS HASP & STAPLE
TECHNICAL DATA

DPS CODE	ITEM CODE	SIZE	LENGTH	WIDTH	THICKNESS	SCREW NO.	WT./PCS	PCS. IN INNER	PCS. IN OUTER
GB0617	BMIH0617050	2"	45	17	1.4	4	0.016	20	500
GB0617	BMIH0617063	2.5"	60	17	1.4	4	0.018	20	500
GB0617	BMIH0617075	3"	70	17	1.4	4	0.020	20	500
GB0617	BMIH0617100	4"	95	22	1.4	4	0.037	20	400

FINISH AVAILABLE : POLISHED & LACQUERED BRASS, CP, SNP

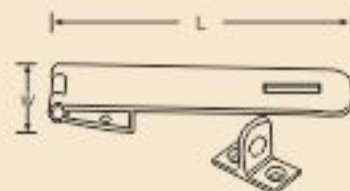

151LH / 151RH : MILD STEEL PADLOCK PROTECTION BAR (RIGHT HAND & LEFT HAND)

TECHNICAL DATA

DPG CODE	ITEM CODE	SIZE	LENGTH	WIDTH	THICK.	BOLT NO	WT/ PCS	PCS. IN INNER	PCS. IN OUTER	PCS. IN PALLET
151LH	MIRN151L185	7"	180	58	2.0	M6	0.690	2	30	1080
151RH	MIRN151R185	7"	180	58	2.0	M6	0.690	2	30	1080
152LH	MIRN152L185	7"	185	64	2.0	M6	1.000	2	20	720
152RH	MIRN152R185	7"	185	64	2.0	M6	1.000	2	20	720

FINISH AVAILABLE : EXB, TEXTURE BLK, EXW, ZP, DUROSIL, HSG

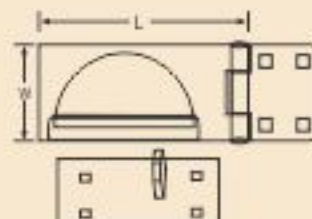
149LW : MILD STEEL WIRE HASP AND STAPLE (LIGHT PATTERN)

TECHNICAL DATA

ITEM CODE	SIZE	LENGTH	WIDTH	THICKNESS	SCREW NO.	WT/ PCS	PCS. IN INNER	PCS. IN OUTER	PCS. IN PALLET
MIRN0150075	3"	76	26	1.0	4	0.018	50	800	24000
MIRN0150100	4"	101	26	1.0	4	0.022	50	500	24000

FINISH AVAILABLE : EXB, TEXTURE BLK, EXW, ZP, DUROSIL, HSG

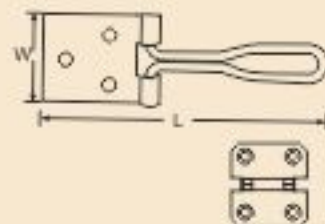

149W : MILD STEEL WIRE HASP AND STAPLE

TECHNICAL DATA

ITEM CODE	SIZE	LENGTH	WIDTH	THICKNESS	SCREW NO.	WT/ PCS	PCS. IN INNER	PCS. IN OUTER	PCS. IN PALLET
MIRN149W125	5"	125	45	2.0	8	0.080	10	200	5600
MIRN149W150	6"	150	45	2.0	8	0.088	10	200	5600

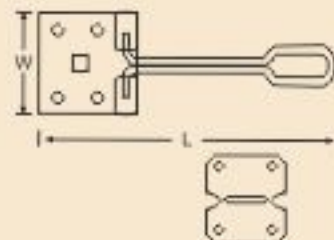
FINISH AVAILABLE : EXB, TEXTURE BLK, EXW, ZP, DUROSIL, HSG

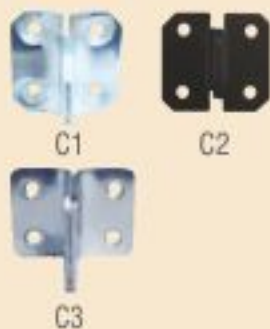

SPARES : MILD STEEL STAPLE ONLY

TECHNICAL DATA

ITEM CODE	LENGTH	WIDTH	THICKNESS	SCREW NO.	WT/PCS	PCS. IN INNER	PCS. IN OUTER
MIRN617SXX (C1)	38	38	1.80	8	0.031	25	250
MIRN617ESXX (C2)	38	42	2.00	7	0.030	25	250
MIRN149WSXX (C3)	20	25	1.00	4	0.008	50	500

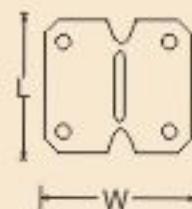
FINISH AVAILABLE : EXB, TEXTURE BLK, EXW, ZP, DUROSIL, HSG

1010 : MILD STEEL GARAGE DOOR HOLDER FOR WIDE LINTELS (SENIOR)

TECHNICAL DATA

ITEM CODE	SIZE	LENGTH	WIDTH	THICKNESS	SCREW NO.	WT/PCS	PCS. IN INNER	PCS. IN OUTER	PCS. IN PALLET
MGR1010600	24"	620	58	4.0	10	1.022	2	20	220

FINISH AVAILABLE : EXB, TEXTURE BLK, EXW, ZP, DUROSIL, HSG

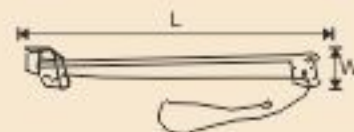
1011 : MILD STEEL GARAGE DOOR HOLDER FOR NARROW LINTELS

TECHNICAL DATA

ITEM CODE	SIZE	LENGTH	WIDTH	THICKNESS	SCREW NO.	WT/PCS	PCS. IN INNER	PCS. IN OUTER	PCS. IN PALLET
MGR1011600	24"	620	58	4.0	10	1.030	2	20	220

FINISH AVAILABLE : EXB, TEXTURE BLK, EXW, ZP, DUROSIL, HSG

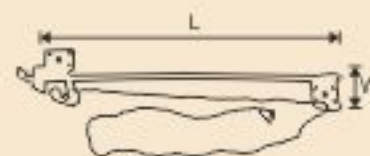

1012 : MILD STEEL GARAGE DOOR HOLDER FOR WIDE LINTELS (JUNIOR)

TECHNICAL DATA

ITEM CODE	SIZE	LENGTH	WIDTH	THICKNESS	SCREW NO.	WT/ PCS	PCS. IN INNER	PCS. IN OUTER	PCS. IN PALLET
MGR1012375	15"	390	58	4.0	10	0.752	2	20	320

FINISH AVAILABLE : EXB, TEXTURE BLK, EXW, ZP, DUROSIL, HSG

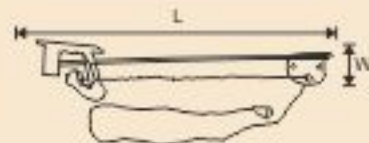
SSB001 : MILD STEEL SHED SECURITY BAR

TECHNICAL DATA

ITEM CODE	LENGTH	OVAL SIZE	WT/PCS	PCS. IN INNER	PCS. IN OUTER
MSCF1024M3	1080	38X20	1.806	1	10

FINISH AVAILABLE : EXB, TEXTURE BLK, EXW, ZP, DUROSIL, HSG

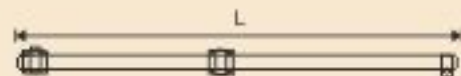
236FB : MILD STEEL HANDRAIL BRACKET FIX BENDED (EURO) (FRENCH SPECIFICATION)

TECHNICAL DATA

ITEM CODE	SIZE	LENGTH	TOP PLATE L x W	ROD DIA	SCREW NO.	WT/ PCS	PCS. IN INNER	PCS. IN OUTER	PCS. IN PALLET
MFRN0237075	3"	75	70x18	10	10	0.148	10	100	2400

FINISH AVAILABLE : EXB, TEXTURE BLK, EXW, ZP, DUROSIL, HSG



236AB/AS : MILD STEEL HANDRAIL BRACKETS ADJUSTABLE BENDED/STRAIGHT (FRENCH SPECIFICATION)

TECHNICAL DATA

ITEM CODE	SIZE	LENGTH	WIDTH	ROD DIA	SCREW NO.	WT/ PCS	PCS. IN INNER	PCS. IN OUTER	PCS. IN PALLET
MIRN0238050	2.5"	50/70	18	10	10	0.180	10	100	2800
MIRN0239055	3"	55/80	18	10	10	0.200	10	100	2400

FINISH AVAILABLE : EXB, TEXTURE BLK, EXW, ZP, DUROSIL, HSG

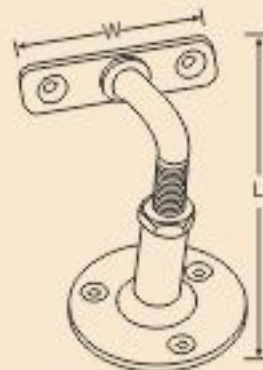
236 : MILD STEEL HANDRAIL BRACKET

TECHNICAL DATA

ITEM CODE	SIZE	LENGTH	TOP PLATE	ROD DIA	SCREW NO.	WT/ PCS	PCS. IN INNER	PCS. IN OUTER	PCS. IN PALLET
MIRN0236063	2.5"	65	60x22	10	8	0.125	10	100	2800
MIRN0236075	3"	77	60x22	10	8	0.136	10	100	2400

FINISH AVAILABLE : EXB, TEXTURE BLK, EXW, ZP, DUROSIL, HSG

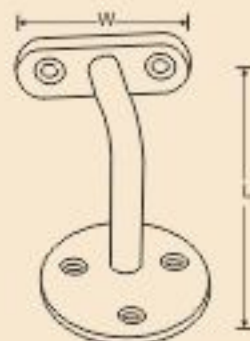
236L : MILD STEEL HANDRAIL BRACKET (ECO)

TECHNICAL DATA

ITEM CODE	SIZE	LENGTH	TOP PLATE	ROD DIA	SCREW NO.	WT/ PCS	PCS. IN INNER	PCS. IN OUTER	PCS. IN PALLET
MIRN236L063	2.5"	65	60x22	8	8	0.105	10	100	2800
MIRN236L075	3"	77	60x22	8	8	0.116	10	100	2400

FINISH AVAILABLE : EXB, TEXTURE BLK, EXW, ZP, DUROSIL, HSG

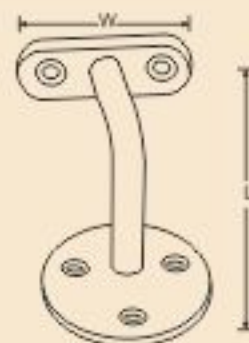

BRASS HANDRAIL BRACKET

TECHNICAL DATA

DPG CODE	ITEM CODE	SIZE	LENGTH	TOP PLATE	BASE DIA	SCREW NO.	WT/ PCS	PCS. IN INNER	PCS. IN OUTER	PCS. IN PALLET
GB0236	8MIH0236065	2.5"	62	45x20	55	7	0.130	10	100	2800
GB0236	8MIH0236076	3"	77	47x20	57	7	0.160	10	80	2400
GB0236H	8MIH236H076	3"	66	51x19	59	7	0.202	10	80	2400

FINISH AVAILABLE : POLISHED & LACQUERED BRASS/CP/SNP

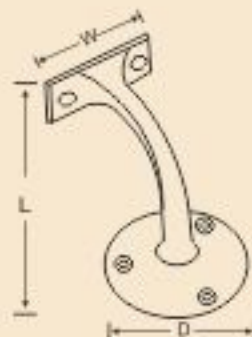
BRASS HEAVY DUTY HANDRAIL BRACKET

TECHNICAL DATA

DPG CODE	ITEM CODE	LENGTH	TOP PLATE	BASE DIA	SCREW NO.	WT/ PCS	PCS. IN INNER	PCS. IN OUTER	PCS. IN PALLET
GB0236S	8MIH236S065	65	47x20	57	6	0.168	10	100	2800

FINISH AVAILABLE : POLISHED & LACQUERED BRASS, CP, SNP

ALUMINIUM HANDRAIL BRACKET

TECHNICAL DATA

DPG CODE	ITEM CODE	LENGTH	TOP PLATE	BASE DIA	SCREW NO.	WT/ PCS	PCS. IN INNER	PCS. IN OUTER	PCS. IN PALLET
GA1475	AMH1475063	62	50x22	61	8	0.122	10	80	2400

 FINISH AVAILABLE : SAA, PAA
 SIZE AVAILABLE : 3" (GA1476)

BLACK ANTIQUE HANDRAIL BRACKET

TECHNICAL DATA

DPG CODE	ITEM CODE	LENGTH	TOP PLATE	BASE DIA	SCREW NO.	WT/ PCS	PCS. IN INNER	PCS. IN OUTER	PCS. IN PALLET
G0236	CMIH0236XXX	65	60X22	58	8	0.260	10	80	2400

FINISH AVAILABLE : EXB, DUROSIL, HSG, PEWTER

497 : MILD STEEL TOP FLAP STAY

TECHNICAL DATA

ITEM CODE	LENGTH	WIDTH	THICKNESS	SCREW NO.	WT/ PCS	PCS. IN INNER	PCS. IN OUTER	PCS. IN PALLET
MMIH0497150	210	44	2.5	6	0.051	10	200	6400

FINISH AVAILABLE : NP WITH WHITE BOSS

498 : MILD STEEL SOLID LID STAY

TECHNICAL DATA

ITEM CODE	LENGTH	WIDTH	THICKNESS	SCREW NO.	WT/ PCS	PCS. IN INNER	PCS. IN OUTER	PCS. IN PALLET
MMIH0498200	210	44	2.5	6	0.050	10	200	3600

FINISH AVAILABLE : NP



319L : MILD STEEL CORNER BRACES (LIGHT) COUNTER SUNK - INSIDE/OUTSIDE
TECHNICAL DATA

ITEM CODE	SIZE	LENGTH	WIDTH	THICKNESS	SCREW NO.	WT./PCS	PCS. IN INNER	PCS. IN OUTER	PCS. IN PALLET
MIRN0319025	1"	25	16	1.6	6	0.009	50	2200	96800
MIRN0319038	1.5"	38	16	1.6	6	0.012	50	1500	60000
MIRN0319050	2"	50	16	1.6	6	0.019	50	1000	39000
MIRN0319065	2.5"	65	16	1.7	6	0.025	50	800	28800
MIRN0319075	3"	75	16	1.7	7	0.030	50	500	12000
MIRN0319100	4"	100	22	2.30	7	0.075	25	250	10000
MIRN0319125	5"	125	22	2.30	7	0.096	25	200	9600
MIRN0319150	6"	150	26	2.5	8	0.145	25	150	7200



FINISH AVAILABLE : EXB, TEXTURE BLK, EXW, ZP, DUROSIL, HSG
 NOTE : 320 INSIDE COUNTERSUNK AND 321 OUTSIDE COUNTERSUNK ALSO AVAILABLE.

319H : MILD STEEL CORNER BRACES (HEAVY) COUNTER SUNK - INSIDE/OUTSIDE
TECHNICAL DATA

ITEM CODE	SIZE	LENGTH	WIDTH	THICKNESS	SCREW NO.	WT./PCS	PCS. IN INNER	PCS. IN OUTER	PCS. IN PALLET
MIRN0320027	1"	27	16	2.0	6	0.011	50	2200	96800
MIRN0320038	1.5"	39	16	2.0	6	0.015	50	1500	58500
MIRN0320050	2"	52	16	2.0	6	0.021	50	1000	39000
MIRN0320065	2.5"	66	19	2.0	6	0.035	50	800	28800
MIRN0320075	3"	76	19	2.0	6	0.037	50	500	24000
MIRN0320100	4"	101	22	2.5	7	0.082	25	250	10000
MIRN0320125	5"	127	22	2.5	7	0.102	25	200	9000
MIRN0320150	6"	152	25	2.5	7	0.146	25	150	7650



FINISH AVAILABLE : EXB, TEXTURE BLK, EXW, ZP, DUROSIL, HSG
 NOTE : 320 INSIDE COUNTERSUNK AND 321 OUTSIDE COUNTERSUNK ALSO AVAILABLE.

319RC : MILD STEEL ROUND CORNER BRACKET
TECHNICAL DATA

ITEM CODE	SIZE	LENGTH	WIDTH	THICKNESS	SCREW NO.	WT./PCS	PCS. IN INNER	PCS. IN OUTER	PCS. IN PALLET
MIRN0321019	3/4"	19	19	1.0	8	0.004	1000	5000	180000

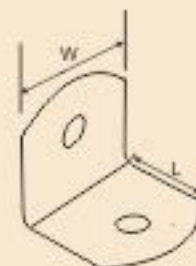

FINISH AVAILABLE : EXB, TEXTURE BLK, EXW, ZP, DUROSIL, HSG

218 : MILD STEEL STRETCHER PLATE (LIGHT)

TECHNICAL DATA

ITEM CODE	SIZE	LENGTH	WIDTH W1XW2	THICKNESS	SCREW NO.	WT/ PCS	PCS. IN INNER	PCS. IN OUTER	PCS. IN PALLET
MFRN0218025	1"	28	25X25	1.15	6	0.011	100	1000	40000

FINISH AVAILABLE : EXB, TEXTURE BLK, EXW, ZP, DUROSIL, HSG

315 : MILD STEEL STRETCHER PLATE

TECHNICAL DATA

ITEM CODE	SIZE	LENGTH	WIDTH W1XW2	THICKNESS	SCREW NO.	WT/ PCS	PCS. IN INNER	PCS. IN OUTER	PCS. IN PALLET
MFRN0315038	1.5"	38	25X29	1.8	8	0.025	100	800	36000

FINISH AVAILABLE : EXB, TEXTURE BLK, EXW, ZP, DUROSIL, HSG

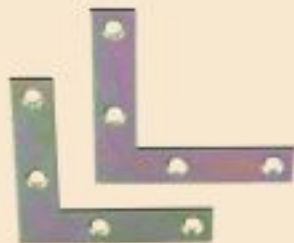
324 : MILD STEEL CORNER PLATE

TECHNICAL DATA

ITEM CODE	SIZE	LENGTH	WIDTH	THICKNESS	SCREW NO.	WT/ PCS	PCS. IN INNER	PCS. IN OUTER	PCS. IN PALLET
MFRN0324050	2"	50	13	1.5	6	0.014	50	1500	58500
MFRN0324065	2.5"	67	13	2.0	7	0.022	50	1000	40000
MFRN0324075	3"	78	16	2.0	8	0.035	50	600	26800
MFRN0324100	4"	100	16	2.65	8	0.054	25	400	16000
MFRN0324125	5"	125	19	2.65	8	0.091	25	225	9000
MFRN0324150	6"	150	22	2.65	8	0.122	25	150	6750

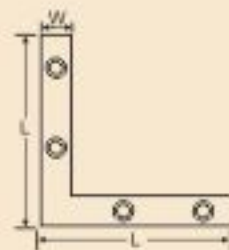
FINISH AVAILABLE : EXB, TEXTURE BLK, EXW, ZP, DUROSIL, HSG



318 : MILD STEEL TEE PLATE

TECHNICAL DATA

ITEM CODE	SIZE	LENGTH	WIDTH	THICKNESS	SCREW NO.	WT/ PCS	PCS. IN INNER	PCS. IN OUTER	PCS. IN PALLET
MIRN0318075	3"	76	16	2.0	8	0.031	25	400	24000
MIRN0318100	4"	100	19	2.0	8	0.052	25	250	15000

FINISH AVAILABLE : EXB, TEXTURE BLK, EXW, ZP, DUROSIL, HSG

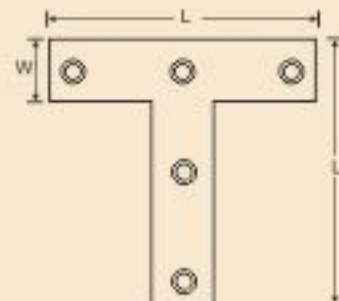
325 : MILD STEEL MENDING PLATE

TECHNICAL DATA

ITEM CODE	SIZE	LENGTH	WIDTH	THICKNESS	SCREW NO.	WT/ PCS	PCS. IN INNER	PCS. IN OUTER	PCS. IN PALLET
MIRN0325075	3"	76	16	1.85	7	0.016	50	1000	50000
MIRN0325100	4"	100	16	2.0	7	0.025	50	700	28000
MIRN0325125	5"	126	19	2.5	8	0.042	25	450	18000
MIRN0325150	6"	151	19	2.5	8	0.053	25	300	12600

FINISH AVAILABLE : EXB, TEXTURE BLK, EXW, ZP, DUROSIL, HSG

325H : MILD STEEL HEAVY MENDING PLATE

TECHNICAL DATA

ITEM CODE	SIZE	LENGTH	WIDTH	THICKNESS	SCREW NO.	WT/ PCS	PCS. IN INNER	PCS. IN OUTER	PCS. IN PALLET
MIRN325H075	3"	75	19	2.5	7	0.025	50	800	28000
MIRN325H100	4"	100	25	2.5	8	0.049	50	400	16000
MIRN325H125	5"	125	25	2.5	9	0.057	25	350	12600
MIRN325H150	6"	150	25	2.5	9	0.070	25	300	12600

FINISH AVAILABLE : EXB, TEXTURE BLK, EXW, ZP, DUROSIL, HSG



316/317 : MILD STEEL SLOT PLATE (HEAVY) HORIZONTAL/VERTICAL

TECHNICAL DATA

ITEM CODE	SIZE	LENGTH	WIDTH	THICKNESS	SCREW NO.	WT./PCS	PCS. IN INNER	PCS. IN OUTER
MIRN0316050	2"	50	36	3.0	10	0.040	100	600
MIRN0317050	2"	50	38	3.0	10	0.040	100	600

FINISH AVAILABLE : EXB, TEXTURE BLK, EXW, ZP, DUROSIL, HSG

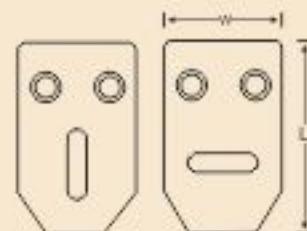
316A/317A : MILD STEEL SLOT PLATE (LIGHT) HORIZONTAL/ VERTICAL

TECHNICAL DATA

ITEM CODE	SIZE	LENGTH	WIDTH	THICKNESS	SCREW NO.	WT./PCS	PCS. IN INNER	PCS. IN OUTER
MIRN316A045	1.5"	44	32	2.35	8	0.022	100	600
MIRN317A045	1.5"	44	32	2.35	8	0.022	100	600

FINISH AVAILABLE : EXB, TEXTURE BLK, EXW, ZP, DUROSIL, HSG

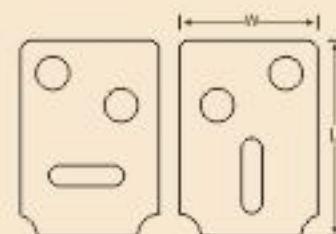
70070 : MILD STEEL FLANGE BRACKET

TECHNICAL DATA

ITEM CODE	SIZE	LENGTH	WIDTH	THICKNESS	SCREW NO.	WT./PCS	PCS. IN INNER	PCS. IN OUTER	PCS. IN PALLET
MIRN7007083	3.25"	83	83	1	4	0.031	50	500	24000

FINISH AVAILABLE : EXB, TEXTURE BLK, EXW, ZP, DUROSIL, HSG

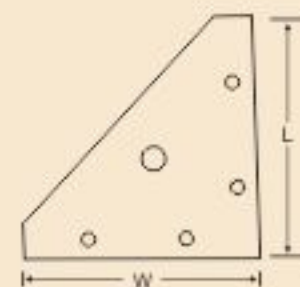

70080 : MILD STEEL CORNER BRACKET

TECHNICAL DATA

ITEM CODE	SIZE	LENGTH	WIDTH	THICKNESS	SCREW NO.	WT/ PCS	PCS. IN INNER	PCS. IN OUTER	PCS. IN PALLET
MIRN7008050	2.5"	64	64	1.0	4	0.034	50	500	22500

FINISH AVAILABLE : EXB, TEXTURE BLK, EXW, ZP, DUROSIL, HSG

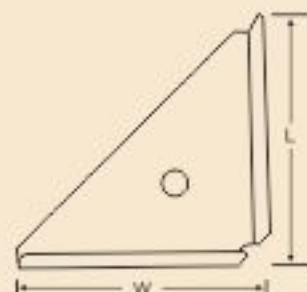
329 : MILD STEEL Z BRACKET

TECHNICAL DATA

ITEM CODE	SIZE	LENGTH	WIDTH	THICKNESS	SCREW NO.	WT/ PCS	PCS. IN INNER	PCS. IN OUTER	PCS. IN PALLET
MIRN0329035	35MM	68	31	1.0	4	0.034	50	1000	22500
MIRN0330028	28MM	66	28	1.0	4	0.018	50	1000	39000

FINISH AVAILABLE : EXB, TEXTURE BLK, EXW, ZP, DUROSIL, HSG

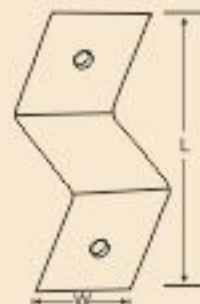
326 : MILD STEEL CONNECTING BRACKET

TECHNICAL DATA

ITEM CODE	SIZE	LENGTH	WIDTH	THICKNESS	SCREW NO.	WT/PCS	PCS. IN INNER	PCS. IN OUTER
MIRN0326050	2"	50	21	1.3	4	0.011	100	1000
MIRN0326075	3"	73	21	1.3	4	0.017	100	1000

FINISH AVAILABLE : EXB, TEXTURE BLK, EXW, ZP, DUROSIL, HSG

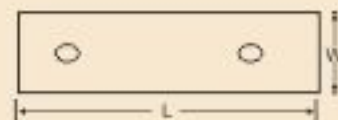

327 : MILD STEEL TWISTED BRACKET

TECHNICAL DATA

ITEM CODE	SIZE	LENGTH	WIDTH	THICKNESS	SCREW NO.	WT./PCS	PCS. IN INNER	PCS. IN OUTER
MIRN0327050	2"	60	18	0.9	4	0.005	100	1000

FINISH AVAILABLE : EXB, TEXTURE BLK, EXW, ZP, DUROSIL, HSG

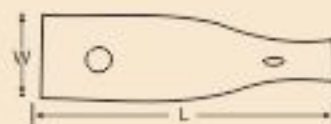
331 : MILD STEEL RIDGE PLATE

TECHNICAL DATA

ITEM CODE	SIZE	LENGTH	WIDTH	THICKNESS	SCREW NO.	WT./PCS	PCS. IN INNER	PCS. IN OUTER
MIRN0331038	1.5"	27X26	38	1.4	4	0.025	50	500

FINISH AVAILABLE : EXB, TEXTURE BLK, EXW, ZP, DUROSIL, HSG

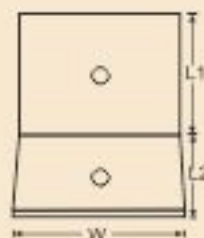
585 : MILD STEEL MIRROR PLATE PLAIN

TECHNICAL DATA

ITEM CODE	SIZE	LENGTH	WIDTH	THICKNESS	SCREW NO.	WT./PCS	PCS. IN INNER	PCS. IN OUTER
MIRN0585025	1"	25	27	0.8	4	0.003	100	2000
MIRN0585032	1.25"	32	32	0.8	4	0.005	100	2000
MIRN0585038	1.5"	38	38	0.8	4	0.006	100	2000
MIRN0585050	2"	50	50	0.8	4	0.009	100	2000

FINISH AVAILABLE : EXB, TEXTURE BLK, EXW, ZP, DUROSIL, HSG

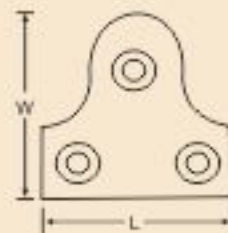

585S : MILD STEEL MIRROR PLATE SLOTTED

TECHNICAL DATA

ITEM CODE	SIZE	LENGTH	WIDTH	THICKNESS	SCREW NO.	WT./PCS	PCS. IN INNER	PCS. IN OUTER
MIRN585S025	1"	25	27	0.8	4	0.003	100	2000
MIRN585S032	1.25"	32	32	0.8	4	0.005	100	2000
MIRN585S038	1.5"	38	38	0.8	4	0.006	100	2000
MIRN585S050	2"	50	50	0.8	4	0.009	100	2000

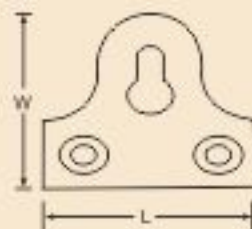

FINISH AVAILABLE : EXB, TEXTURE BLK, EXW, ZP, DUROSIL, HSG

70090 : MILD STEEL MINI MOUNT

TECHNICAL DATA

ITEM CODE	SIZE	LENGTH	WIDTH	THICKNESS	SCREW NO.	WT./PCS	PCS. IN INNER	PCS. IN OUTER
MIRN7009000	1.5"	40	16	1.4	4	0.005	100	2000

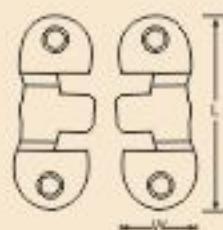

FINISH AVAILABLE : EXB, TEXTURE BLK, EXW, ZP, DUROSIL, HSG



780



401

LARGE PATTERN TABLE BRACE PLATE
TWISTED SUPPORT BRACKET

FINISH AVAILABLE : EXB, TEXTURE BLK, EXW, ZP, DUROSIL, HSG

1247 : MILD STEEL FLUTED ANGLE BRACKET
TECHNICAL DATA

ITEM CODE	SIZE	LENGTH	WIDTH	THICKNESS	SCREW NO.	WT/ PCS	PCS. IN OUTER	PCS. IN PALLET
MGF1247075	3"x2"	75x50	20	3.7	8	0.093	20	3760
MGF1247100	4"x3"	100x75	20	3.7	8	0.136	20	2000
MGF1247125	5"x4"	125x100	20	3.7	8	0.180	20	2000
MGF1247150	6"x5"	150x125	25	5.0	8	0.361	20	1000
MGF1247200	8"x6"	200x150	25	5.0	8	0.445	20	900
MGF1247250	10"x8"	250x200	25	5.0	8	0.580	20	720
MGF1247300	12"x10"	300x250	25	5.0	8	0.703	20	720
MGF1247350	14"x12"	350x300	25	5.0	8	0.830	20	720

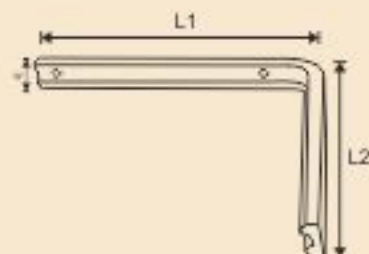

FINISH AVAILABLE : EXB, TEXTURE BLK, EXW, ZP, DUROSIL, HSG

MILD STEEL SHELF BRACKET (LONDON PATTERN)
TECHNICAL DATA

DPG CODE	ITEM CODE	SIZE	LENGTH	WIDTH	THICKNESS	SCREW NO.	WT/ PCS	PCS. IN INNER	PCS. IN OUTER	PCS. IN PALLET
D701	MMHD701100	4"x3"	100x75	32	1.0	4	0.029	20	240	11520
D702	MMHD702125	5"x4"	125x100	34	1.0	4	0.040	20	240	9360
D703	MMHD703150	6"x5"	150x125	34	1.0	4	0.050	20	240	5760
D704	MMHD704200	8"x6"	200x150	40	1.0	4	0.079	20	160	4800
D705	MMHD705225	9"x7"	225x175	40	1.0	6	0.097	20	140	2520
D706	MMHD706250	10"x8"	250x200	42	1.0	6	0.107	20	140	2520
D707	MMHD707300	12"x10"	300x250	47	1.0	6	0.149	20	100	1800
D708	MMHD708350	14"x12"	350x300	50	1.0	6	0.174	20	60	1080

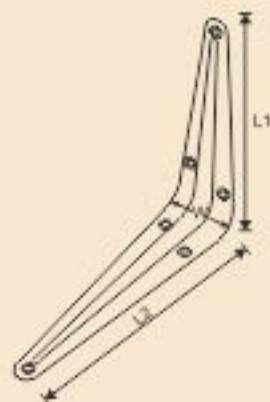

FINISH AVAILABLE : EXW, EXB, EXGR

70050 : MILD STEEL CISTERN BRACKET
TECHNICAL DATA

ITEM CODE	SIZE	LENGTH	WIDTH	THICKNESS	SCREW NO.	WT/ PCS	PCS. IN INNER	PCS. IN OUTER
MRR7050100	4"x4"	100x100	31	1.0	8	0.055	20	160

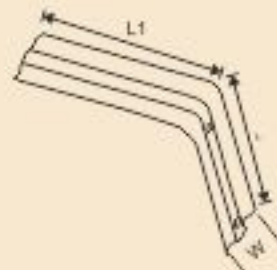

FINISH AVAILABLE : EXB, TEXTURE BLK, EXW, ZP, DUROSIL, HSG

SHELF BRACKET STAYED

TECHNICAL DATA

DPG CODE	ITEM CODE	SIZE	LENGTH	WIDTH	THICKNESS	SCREW NO.	WT/ PCS	PCS. IN INNER	PCS. IN OUTER
D608	MMHD608300	12"X14"	305X358	20	5	8	0.786	6	12
D610	MMHD610350	14"X16"	356X406	20	5	8	0.905	6	12
D612	MMHD612400	16"X18"	406X457	20	5	8	1.040	6	12

FINISH AVAILABLE : EXB, EXW, GREY

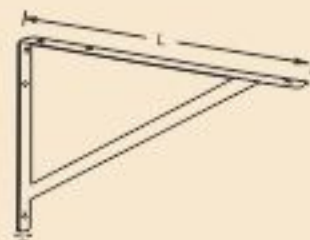
ORNAMENTAL SELF BRACKET

TECHNICAL DATA

DPG CODE	ITEM CODE	SIZE	LENGTH	WIDTH	THICKNESS	SCREW NO.	WT/ PCS	PCS. IN INNER	PCS. IN OUTER
D404	MMHD404100	4"X4"	110X110	12	2.5	6	0.124	10	50
D406	MMHD406150	6"X6"	152X152	12	2.5	6	0.165	10	10
D408	MMHD408200	8"X8"	203X203	12	2.5	6	0.205	10	10
D410	MMHD410250	10"X10"	254X254	12	2.5	6	0.254	10	10

FINISH AVAILABLE : EXB, EXW, GREY

BLACK ANTIQUE TURN BUTTON

TECHNICAL DATA

DPG CODE	ITEM CODE	SIZE	LENGTH	WIDTH	SCREW NO.	WT/ PCS	PCS. IN INNER	PCS. IN OUTER	PCS. IN PALLET
G1801	CMH1801038	1.5"	38	11	7	0.011	100	1000	48000
G1802	CMH1802050	2"	51	13	8	0.020	50	500	25000
G1803	CMH1803065	2.5"	65	17	8	0.040	50	400	16800

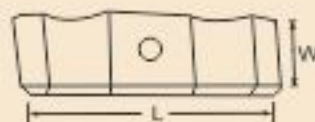
 FINISH AVAILABLE : EXB, DUROSIL, HSG, PEWTER
 SIZE AVAILABLE : 1½" (G1800)

BLACK ANTIQUE WING TURN BUTTON

TECHNICAL DATA

DPG CODE	ITEM CODE	SIZE	LENGTH	WIDTH	SCREW NO.	WT./PCS	PCS. IN INNER	PCS. IN OUTER
G1850	CMH185038	1.5"	40	13	7	0.013	100	1000
G1851	CMH1851050	2"	50	13	7	0.019	100	1000



FINISH AVAILABLE : EXB, EXW, DUROSIL, HSG, PEWTER

BLACK ANTIQUE HALF TURN BUTTON

TECHNICAL DATA

DPG CODE	ITEM CODE	LENGTH	WIDTH	SCREW NO.	WT./PCS	PCS. IN INNER	PCS. IN OUTER
G1820	CMH1820030	32	13	8	0.015	100	1000



FINISH AVAILABLE : EXB, EXW, DUROSIL, HSG, PEWTER

BLACK ANTIQUE CLEAT HOOK

TECHNICAL DATA

DPG CODE	ITEM CODE	SIZE	LENGTH	WIDTH	SCREW NO.	WT./PCS	PCS. IN INNER	PCS. IN OUTER	PCS. IN PALLET
G2002	CMH2002075	3"	76	25	6	0.053	30	300	12000
G2003	CMH2003100	4"	100	25	10	0.070	25	250	10000
G2004	CMH2004125	5"	128	28	10	0.092	25	250	8000
G2005	CMH2005150	6"	151	28	10	0.103	25	150	7500

 FINISH AVAILABLE : EXB, EXW, DUROSIL, HSG, PEWTER
 SIZE AVAILABLE IN 50MM (G2001)

790 : MILD STEEL QUADRANT STAY - LEFT HANDED & RIGHT HANDED

TECHNICAL DATA

ITEM CODE	SIZE	LENGTH	WIDTH	THICKNESS	SCREW NO.	WT/ SET	SET. IN INNER	SET. IN OUTER	SET. IN PALLET
MMH0790150	6"	176	60	2.6	10	0.180	5	50	2000
MMH0790200	8"	220	64	2.6	10	0.224	5	50	2000
MMH0790250	10"	265	73	2.2	10	0.240	5	50	1600

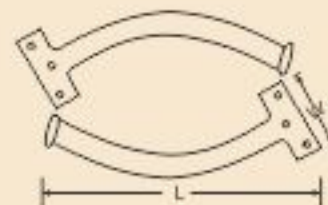

FINISH AVAILABLE : EXB, TEXTURE BLK, EXW, ZP, DUROSIL, HSG

GP039 : MILD STEEL SINGLE SCREW PULLEY

TECHNICAL DATA

ITEM CODE	SIZE	LENGTH	WIDTH	THICKNESS	WHEEL DIA	WT/ PCS	PCS. IN INNER	PCS. IN OUTER	PCS. IN PALLET
MPUL0039045	1.75"	40	62	2	43	0.074	10	100	3600

FINISH AVAILABLE : EXB, TEXTURE BLK, EXW, BZP, DUROSIL, HSG

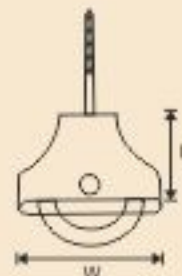
GP042 : MILD STEEL DOUBLE SCREW PULLEY

TECHNICAL DATA

ITEM CODE	SIZE	LENGTH	WIDTH	THICKNESS	WHEEL DIA	WT/ PCS	PCS. IN INNER	PCS. IN OUTER	PCS. IN PALLET
MPUL0042045	1.75"	38	68	2	43	0.115	10	100	3600

FINISH AVAILABLE : EXB, TEXTURE BLK, EXW, BZP, DUROSIL, HSG

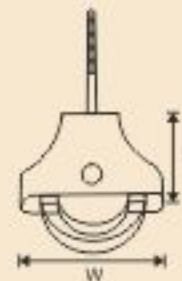

GP260 : MILD STEEL SINGLE CLOTHES LINE PULLEY

TECHNICAL DATA

ITEM CODE	SIZE	LENGTH	WIDTH	THICKNESS	WHEEL DIA	WT/ PCS	PCS. IN INNER	PCS. IN OUTER	PCS. IN PALLET
MPUL0260032	1.25"	114	32	1.9	30	0.097	10	100	3600

FINISH AVAILABLE : EXB, TEXTURE BLK, EXW, B2P, DUROSIL, HSG

GP260A : MILD STEEL SINGLE CLOTHES LINE PULLEY

TECHNICAL DATA

ITEM CODE	SIZE	LENGTH	WIDTH	THICKNESS	WHEEL DIA	WT/ PCS	PCS. IN INNER	PCS. IN OUTER	PCS. IN PALLET
MPUL260A038	1.5"	120	38	2.2	35	0.115	10	100	3600

FINISH AVAILABLE : EXB, TEXTURE BLK, EXW, B2P, DUROSIL, HSG

GP202A : MILD STEEL AXLE PULLEY WITH FOREND PLATE, NYLON WHEEL

TECHNICAL DATA

ITEM CODE	SIZE	LENGTH	WIDTH	THICKNESS	WHEEL DIA	WT/ PCS	PCS. IN INNER	PCS. IN OUTER	PCS. IN PALLET
MPUL202A040	1.75"	112	25	3.0	43	0.160	10	100	3600

 FINISH AVAILABLE : EXB, TEXTURE BLK, EXW, B2P, DUROSIL, HSG
 PLATE FINISHES : EB, CP, SMP

GP202 : MILD STEEL AXLE PULLEY NYLON WHEEL

TECHNICAL DATA

ITEM CODE	SIZE	LENGTH	WIDTH	THICKNESS	SCREW NO.	WHEEL DIA	WT/ PCS	PCS. IN INNER	PCS. IN OUTER	PCS. IN PALLET
MPUL0202040	1.75"	112	25	3.0	8	43	0.110	10	100	3600

FINISH AVAILABLE : EXB, TEXTURE BLK, EXW, DUROSIL, BZP, HSG

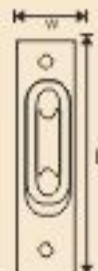
GP202/Q : MILD STEEL ROUND END AXLE PULLEY CAST WHEEL

TECHNICAL DATA

ITEM CODE	SIZE	LENGTH	WIDTH	THICKNESS	SCREW NO.	WHEEL DIA	WT/ PCS	PCS. IN INNER	PCS. IN OUTER	PCS. IN PALLET
MPUL0202045	1.75"	111	35	5.0	10	43	0.150	10	100	3600

FINISH AVAILABLE : EXB, TEXTURE BLK, EXW, DUROSIL, BZP, HSG

GP261 : MILD STEEL SINGLE LINE (AWNING) PULLEY

TECHNICAL DATA

ITEM CODE	SIZE	LENGTH	WIDTH	THICKNESS	WHEEL DIA	WT/ PCS	PCS. IN INNER	PCS. IN OUTER	PCS. IN PALLET
MPUL0261038	1.5"	100	38	2.2	36	0.084	10	100	3600

FINISH AVAILABLE : EXB, TEXTURE BLK, EXW, DUROSIL, BZP, HSG



GP268 : MILD STEEL SINGLE UPRIGHT PULLEY - WHEEL ACROSS THE PLATE

TECHNICAL DATA

ITEM CODE	SIZE	LENGTH	WIDTH	THICKNESS	SCREW NO.	WHEEL DIA	WT/ PCS	PCS. IN INNER	PCS. IN OUTER	PCS. IN PALLET
MPUL0268038	1.5"	70	53	2.2	8	35	0.068	10	100	3600

FINISH AVAILABLE : EXB, TEXTURE BLK, EXW, DUROSIL, B2P, HSG

GP268A : MILD STEEL SINGLE UPRIGHT PULLEY WHEEL ALONG THE PLATE

TECHNICAL DATA

ITEM CODE	SIZE	LENGTH	WIDTH	THICKNESS	SCREW NO.	WHEEL DIA	WT/ PCS	PCS. IN INNER	PCS. IN OUTER	PCS. IN PALLET
MPUL268A038	1.5"	70	53	2.2	8	35	0.066	10	100	3600

FINISH AVAILABLE : EXB, TEXTURE BLK, EXW, DUROSIL, B2P, HSG

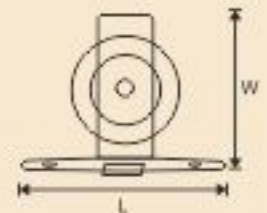
GP202C : CAST IRON SASH PULLEY CAST WHEEL

TECHNICAL DATA

ITEM CODE	SIZE	LENGTH	WIDTH	THICKNESS	SCREW NO.	WHEEL DIA	WT/ PCS	PCS. IN INNER	PCS. IN OUTER	PCS. IN PALLET
MPUL202C044	1.75"	115	35	4.1	10	45	0.214	10	60	3000

FINISH AVAILABLE : EXB, TEXTURE BLK, EXW, DUROSIL, B2P, HSG

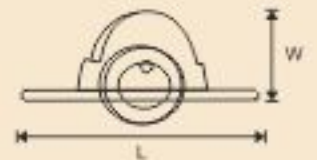

GP202D : MILD STEEL SASH PULLEY WITH BRASS WHEEL

TECHNICAL DATA

ITEM CODE	SIZE	LENGTH	WIDTH	THICKNESS	SCREW NO.	WHEEL DIA.	WT/ PCS	PCS. IN INNER	PCS. IN OUTER	PCS. IN PALLET
MPUL202D044	1.75"	117	39	3.2	6	46	0.152	10	100	3600

FINISH AVAILABLE : POLISHED BRASS & CHROME PLATED FOREND

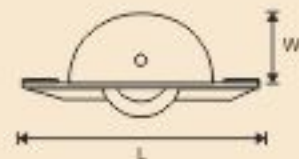
1581 : CAST IRON FAST EYE PULLEY

TECHNICAL DATA

ITEM CODE	SIZE	LENGTH	WIDTH	WHEEL DIA.	WT/ PCS	PCS. IN INNER	PCS. IN OUTER	PCS. IN PALLET
MPUL1581036	1.5"	75	36	36	0.130	10	100	3600

FINISH AVAILABLE : EXB, TEXTURE BLK, EXW, DUROSIL, BZP, HSG

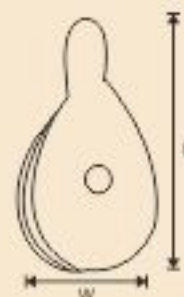
G0051 : BLACK ANTIQUE RACK END (LIGHT WEIGHT)

TECHNICAL DATA

ITEM CODE	SIZE	LENGTH	WIDTH	WT/PCS	PCS. IN INNER	PCS. IN OUTER
CNH0051303	14"	350	93	0.347	5	50

FINISH AVAILABLE : EXB, EXW, PEWTER



1706 : MILD STEEL SPRING DOOR STOP

TECHNICAL DATA

ITEM CODE	LENGTH	WIDTH	SCREW NO.	WT./PCS	PCS. IN INNER	PCS. IN OUTER	PCS. IN PALLET
NMH1706076	78	24	6	0.027	10	200	12000

FINISH AVAILABLE - ELECTROBRASS, NICKEL PLATED



BRASS VICTORIAN PROJECTING DOOR STOP

TECHNICAL DATA

DPG CODE	ITEM CODE	LENGTH	BASE DIA	THICKNESS	SCREW NO.	WT/ PCS	PCS. IN INNER	PCS. IN OUTER	PCS. IN PALLET
GB2702	BMH2702075	76	38	2.6	6	0.073	10	200	6000

FINISH AVAILABLE - POLISHED & LACQUERED BRASS/CP/SNP

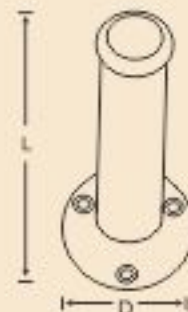
Also Available - GB 2701 (2")

BRASS VICTORIAN SKIRTING DOOR STOP

TECHNICAL DATA

DPG CODE	ITEM CODE	LENGTH	WIDTH	THICKNESS	SCREW NO.	WT/ PCS	PCS. IN INNER	PCS. IN OUTER	PCS. IN PALLET
GB2703	BMH2703063	76	40X40	3.5	6	0.091	10	160	5760

FINISH AVAILABLE - POLISHED & LACQUERED BRASS/CP/SNP

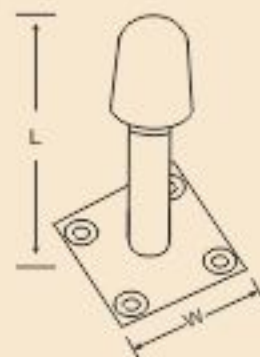

BRASS VICTORIAN OVAL SHIELD DOOR STOP

TECHNICAL DATA

DPG CODE	ITEM CODE	LENGTH	WIDTH	THICKNESS	SCREW NO.	WT/ PCS	PCS. IN INNER	PCS. IN OUTER	PCS. IN PALLET
GB2705	BMH2705038	48	40	2.6	8	0.092	10	160	5760

FINISH AVAILABLE - POLISHED & LACQUERED BRASS/CP/SNP

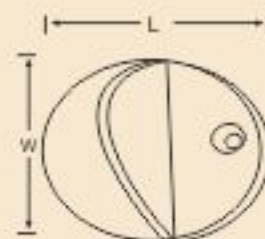
BRASS ROUND SHIELDED DOOR STOP

TECHNICAL DATA

DPG CODE	ITEM CODE	LENGTH	DIA	THICKNESS	SCREW NO.	WT/ PCS	PCS. IN INNER	PCS. IN OUTER	PCS. IN PALLET
GB2707	BMH2707038	31	38	3.7	7	0.095	10	160	5760

FINISH AVAILABLE - POLISHED & LACQUERED BRASS/CP/SNP

ALUMINIUM TUBULAR DOOR STOP

TECHNICAL DATA

DPG CODE	ITEM CODE	LENGTH	BASE DIAMETER	SCREW NO.	WT/ PCS	PCS. IN INNER	PCS. IN OUTER	PCS. IN PALLET
GA1485	AMH1485065	73	41	4	0.025	20	200	7200
GA1484	AMH1484075	86	41	4	0.029	20	200	7200

FINISH AVAILABLE : SAA, PAA

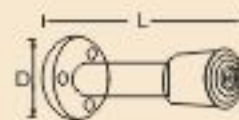

ALUMINIUM OVAL SHIELD DOOR STOP

TECHNICAL DATA

DPG CODE	ITEM CODE	LENGTH	WIDTH	THICKNESS	SCREW NO.	WT/ PCS	PCS. IN INNER	PCS. IN OUTER	PCS. IN PALLET
GA1486	AMH1486XXX	48	41	2.2	6	0.040	10	100	3600

FINISH AVAILABLE : SAA, PAA

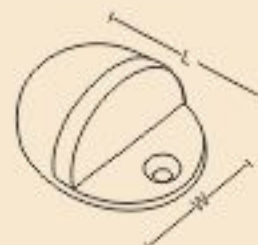
ALUMINIUM ROUND SHIELDED DOOR STOP

TECHNICAL DATA

DPG CODE	ITEM CODE	LENGTH	DIA	SCREW NO.	WT/ PCS	PCS. IN INNER	PCS. IN OUTER	PCS. IN PALLET
GA1488	AMH1488XXX	31	37	7	0.059	10	200	3600

FINISH AVAILABLE : SAA, PAA

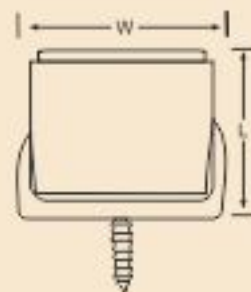
STAINLESS STEEL HALF MOON DOOR STOP

TECHNICAL DATA

DPG CODE	ITEM CODE	LENGTH	WIDTH	THICKNESS	SCREW NO.	WT PCS	PCS. IN INNER	PCS. IN OUTER	PCS. IN PALLET
1486SS	SMH1486XXX	45	45	3.20	8	0.079	10	100	3600

FINISH AVAILABLE : EB, SATIN, MIRROR POLISHED

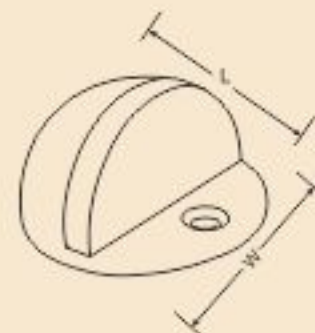

STAINLESS STEEL FLOOR MOUNTED DOOR STOP



TECHNICAL DATA

DPG CODE	ITEM CODE	LENGTH	WIDTH	SCREW NO.	WT/ PCS	PCS. IN INNER	PCS. IN OUTER	PCS. IN PALLET
1487SS	SMIH1487XXX	65	52	8	0.180	10	80	3200

FINISH AVAILABLE : EB, SATIN, MIRROR POLISHED



STAINLESS STEEL ROUND DOOR STOP



TECHNICAL DATA

DPG CODE	ITEM CODE	LENGTH	DIA	BOLT NO	WT/ PCS	PCS. IN INNER	PCS. IN OUTER	PCS. IN PALLET
1489SS	SMIH1489XXX	40	32	M6	0.216	10	50	2250
1490SS	SMIH1490XXX	40	38	M6	0.281	10	50	2250

FINISH AVAILABLE : EB, SATIN, MIRROR POLISHED

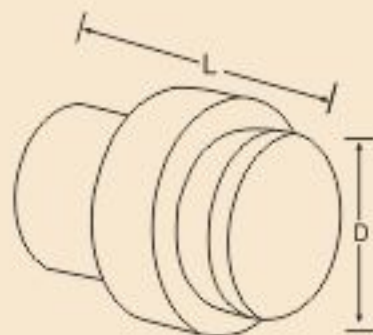

STAINLESS STEEL TUBULAR DOOR STOP



TECHNICAL DATA

DPG CODE	ITEM CODE	LENGTH	DIAMETER	BOLT NO.	WT/ PCS	PCS. IN INNER	PCS. IN OUTER	PCS. IN PALLET
1488SS	SMIH1488XXX	75	19	M6	0.056	10	200	3600

FINISH AVAILABLE : EB, SATIN, MIRROR POLISHED

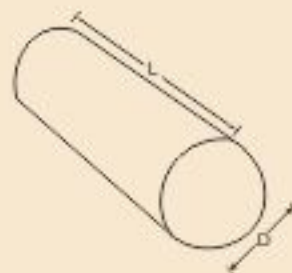

STAINLESS STEEL TUBULAR DOOR STOP (POINTED)



TECHNICAL DATA

DPG CODE	ITEM CODE	LENGTH	DIAMETER	BOLT NO.	WT/ PCS	PCS. IN INNER	PCS. IN OUTER	PCS. IN PALLET
1491SS	SMH1491XXX	87	32	M6	0.110	10	100	4000

FINISH AVAILABLE : EB, SATIN, MIRROR POLISHED

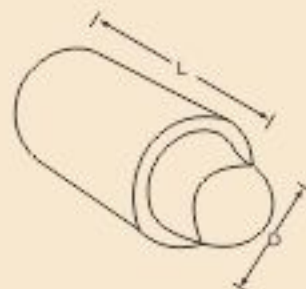

STAINLESS STEEL RECTANGULAR SHAPE DOOR STOP



TECHNICAL DATA

DPG CODE	ITEM CODE	LENGTH	WIDTH	BOLT NO.	WT/ PCS	PCS. IN INNER	PCS. IN OUTER	PCS. IN PALLET
1492SS	SMH1492XXX	75	20	M6	0.081	10	160	5760

FINISH AVAILABLE : EB, SATIN, MIRROR POLISHED

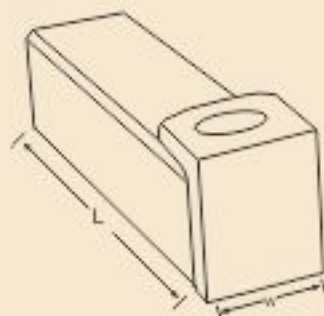

STAINLESS STEEL SQUARE SHAPE DOOR STOP



TECHNICAL DATA

DPG CODE	ITEM CODE	LENGTH	WIDTH	SCREW NO.	BOLT NO.	WT/ PCS	PCS. IN INNER	PCS. IN OUTER	PCS. IN PALLET
1493SS	SMH1493XXX	40	40	7	M6	0.165	10	100	3000

FINISH AVAILABLE : EB, SATIN, MIRROR POLISHED

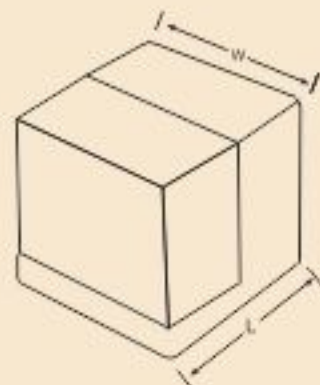

GPL0351 : RUBBER DOOR WEDGE

TECHNICAL DATA

ITEM CODE	LENGTH	WIDTH	SCREW NO.	WT./PCS	PCS. IN INNER	PCS. IN OUTER
PMH0351XXX	135	43	6	0.058	20	240

COLOUR AVAILABLE: BLACK, GREY, BLUE, GREEN, WHITE & CLEAR

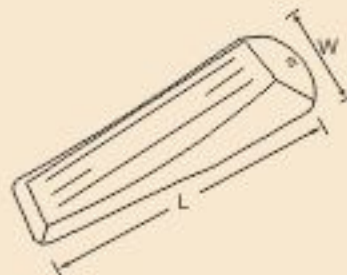
GPL0331 : RUBBER DOOR STOP

TECHNICAL DATA

ITEM CODE	HEIGHT	DIAMETER	SCREW NO.	WT./PCS	PCS. IN INNER	PCS. IN OUTER	PCS. IN PALLET
RHH0331032	21	32	8	0.012	50	500	20000
RHH0331025	21	26	7	0.010	50	500	20000

COLOUR AVAILABLE : BLACK, WHITE



BLACK ANTIQUE DOOR STUD

TECHNICAL DATA

DPG CODE	ITEM CODE	LENGTH	WIDTH	WT./PCS	PCS. IN INNER	PCS. IN OUTER
G1901	CMH1901019	19	19	0.028	50	500

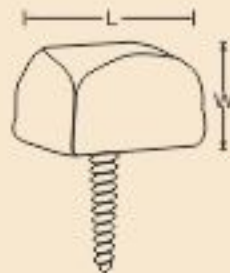
FINISH AVAILABLE : EXB, DUROSIL, PEWTER

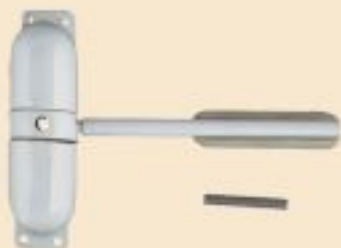

GDC001 : SPRING DOOR CLOSER

KEEPS THE DOOR CLOSED
ADJUSTABLE TENSION LEFT RIGHT
HAND FITTING.

SUITABLE FOR USE ON DOORS UP TO 68 KGS. (150LBS)
FINISHES AVAILABLE : EPOXY WHITE, SATIN NICKEL PLATED
BRASS PLATED, EPOXY BLACK ETC.

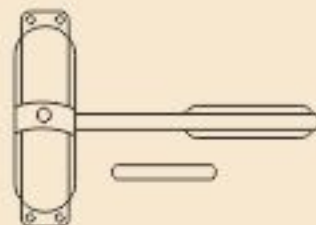
500 : MILD STEEL DOOR SPRING

TECHNICAL DATA

ITEM CODE	SIZE	LENGTH	WIRE DIA	THICKNESS	SCREW NO.	WT/ PCS	PCS. IN INNER	PCS. IN OUTER	PCS. IN PALLET
MGF0500200	8"	200	4	2.40	8	0.275	5	50	2000
MGF0500250	10"	250	4	2.40	8	0.337	5	50	1400

FINISH AVAILABLE - EXB, TEXTURE BLK, EXW, ZP, DUROSIL, EVER BLACK, HSG



VICTORIAN BRASS LETTER PLATE

TECHNICAL DATA

DPG CODE	ITEM CODE	LENGTH	WIDTH	BOLT	WT/ PCS	PCS. IN INNER	PCS. IN OUTER	PCS. IN PALLET
GB0608	BMH0608250	255	75	M6	0.444	5	30	1200
GB0612	BMH0612250	258	98	M6	0.589	5	30	1200
GB0613	BMH0613300	310	101	M6	0.755	5	20	900
GB0615	BMH0615400	410	127	M6	1.620	5	10	450

FINISH AVAILABLE - POLISHED & LACQUERED BRASS/CP/SNP

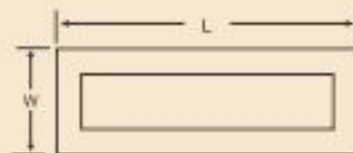
Also Available : GB0614 (14"x5")



VICTORIAN BRASS LETTER PLATE (INTERNAL FLAP COVER)

TECHNICAL DATA

DPG CODE	ITEM CODE	LENGTH	WIDTH	THICKNESS	SCREW NO.	WT/ PCS	PCS. IN INNER	PCS. IN OUTER	PCS. IN PALLET
GB0611	BMH6110250	260	80	1.0	6	0.262	5	50	1000

FINISH AVAILABLE - POLISHED & LACQUERED BRASS/CP/SNP, POLISHED
ALSO AVAILABLE IN STAINLESS STEEL

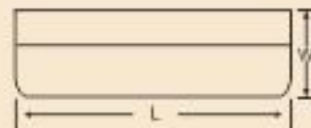
VICTORIAN BRASS LETTER PLATE (WITH KNOCKER)

TECHNICAL DATA

DPG CODE	ITEM CODE	LENGTH	WIDTH	BOLT	WT/ PCS	PCS. IN INNER	PCS. IN OUTER	PCS. IN PALLET
GB0609	BMH0609250	256	78	M6	0.568	5	30	1200

FINISH AVAILABLE - POLISHED & LACQUERED BRASS/CP/SNP

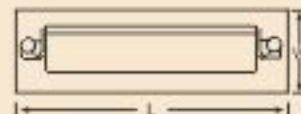

BRASS GEORGIAN POSTAL KNOCKER

TECHNICAL DATA

DPG CODE	ITEM CODE	LENGTH	WIDTH	BOLT	WT/PCS	PCS. IN INNER	PCS. IN OUTER
GB0604	BMH0604250	256	73	M6	0.684	5	20

FINISH AVAILABLE - POLISHED & LACQUERED BRASS/CP/SNP

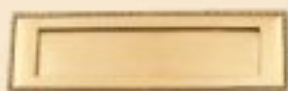

BRASS GEORGIAN LETTER PLATE

TECHNICAL DATA

DPG CODE	ITEM CODE	LENGTH	WIDTH	BOLT	WT/PCS	PCS. IN INNER	PCS. IN OUTER
GB0607	9MH0607250	258	78	M6	0.531	5	30

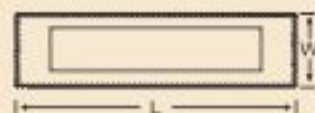
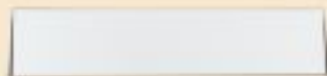
FINISH AVAILABLE - POLISHED & LACQUERED BRASS/CP/SNP
ALSO AVAILABLE GB0606 (11"x3.5")

ALUMINIUM FRONT FIX LETTER PLATE

TECHNICAL DATA

DPG CODE	ITEM CODE	LENGTH	WIDTH	SCREW NO.	WT/PCS	PCS. IN INNER	PCS. IN OUTER	PCS. IN PALLET
GA1201	AMH1201250	255	78	6	0.160	5	50	1400
GA1202	AMH1202300	305	78	6	0.200	5	50	1400

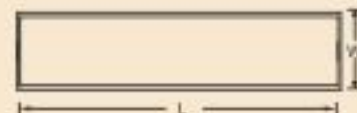
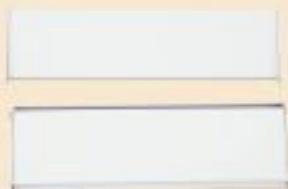
FINISH AVAILABLE : SAA, PAA

ALUMINIUM FRONT FIX LETTER PLATE & TIDY

TECHNICAL DATA

DPG CODE	ITEM CODE	LENGTH	WIDTH	SCREW NO.	WT/PCS	PCS. IN INNER	PCS. IN OUTER
GA1201T	AMH1203250	255	79	6	0.311	1	25

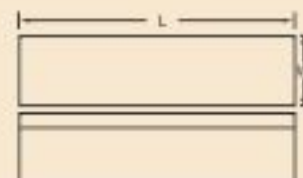
FINISH AVAILABLE : SAA, PAA

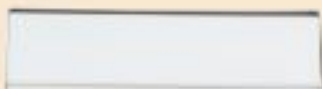

ALUMINIUM REAR FIX LETTER PLATE

TECHNICAL DATA

DPG CODE	ITEM CODE	LENGTH	WIDTH	SCREW NO.	WT./PCS	PCS. IN INNER	PCS. IN OUTER
GA1211	AMH1211250	252	76	M6	0.153	5	50

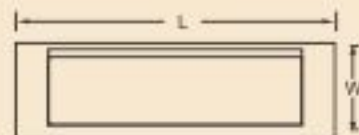
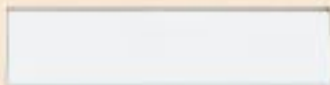
FINISH AVAILABLE : SAA, PAA

ALUMINIUM INNER FLAP

TECHNICAL DATA

DPG CODE	ITEM CODE	LENGTH	WIDTH	SCREW NO.	WT./PCS	PCS. IN INNER	PCS. IN OUTER	PCS. IN PALLET
GA1221	AMH1221250	251	68	6	0.106	5	50	1400
GA1222	AMH1222300	305	68	6	0.119	5	50	1400

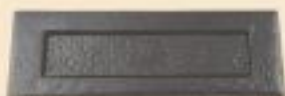
FINISH AVAILABLE : SAA, PAA

BLACK ANTIQUE LETTER PLATE PLAIN

TECHNICAL DATA

DPG CODE	ITEM CODE	LENGTH	WIDTH	BOLT	WT./PCS	PCS. IN INNER	PCS. IN OUTER
G0402	CMH0402250	250	83	M6	0.710	2	16
G0060	CMH0060254	268	88	M6	1.106	2	16
G0405	CMH0405250	250	100	M6	1.200	2	16

FINISH AVAILABLE : EXB, DUROSIL, PEWTER



BLACK ANTIQUE GEORGIAN LETTER PLATE

TECHNICAL DATA

DPG CODE	ITEM CODE	LENGTH	WIDTH	BOLT	WT/PCS	PCS. IN INNER	PCS. IN OUTER
G0065	CMH0065254	248	76	M6	0.765	5	20

FINISH AVAILABLE : EXB, DUROSIL, PEWTER

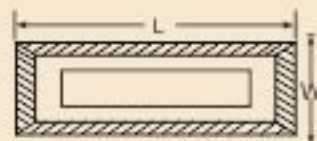

BLACK ANTIQUE FLEUR - DE - LYS ORNATE LETTER PLATE

TECHNICAL DATA

DPG CODE	ITEM CODE	LENGTH	WIDTH	BOLT	WT/PCS	PCS. IN INNER	PCS. IN OUTER
G0404A	CMH404A250	360	80	M6	0.801	5	20

FINISH AVAILABLE : EXB, DUROSIL, PEWTER

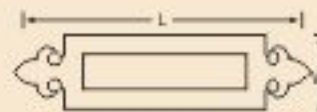
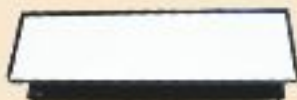
SIZE AVAILABLE : 10" X 4" (G0401), 11" X 4" (G0403), 14" X 3 1/2" (G0404)

GPV021 : UPVC LETTER PLATE

TECHNICAL DATA

ITEM CODE	LENGTH	WIDTH	SCREW NO.	WT/PCS	PCS. IN INNER	PCS. IN OUTER
HMHVP21250	260	72	7	0.354	5	40

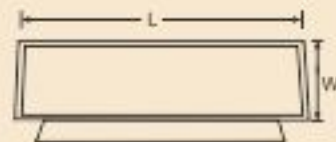
FINISH AVAILABLE : ELECTRO BRASS PLATED, EPOXY WHITE, SATIN NICKEL, CHROME PLATED



BRASS VICTORIAN CYLINDER DOOR PULL

TECHNICAL DATA

DPG CODE	ITEM CODE	LENGTH	WIDTH	WT./PCS	PCS. IN INNER	PCS. IN OUTER
GB0850	BMH0850076	79	41	0.074	20	200

FINISH AVAILABLE : POLISHED & LACQUERED BRASS/CP/SNP
 NOTE: SUITABLE TO USE IN NIGHT LATCH MODEL LAL9001 TO LAL 9008

BRASS GEORGIAN CYLINDER DOOR PULL

TECHNICAL DATA

DPG CODE	ITEM CODE	LENGTH	WIDTH	WT./PCS	PCS. IN INNER	PCS. IN OUTER
GB0860	BMH0860080	81	45	0.081	10	200

FINISH AVAILABLE : POLISHED & LACQUERED BRASS/CP/SNP
 NOTE: SUITABLE TO USE IN NIGHT LATCH MODEL LAL9001 TO LAL 9008

ALUMINIUM CYLINDER PULL

TECHNICAL DATA

DPG CODE	ITEM CODE	LENGTH	WIDTH	WT./PCS	PCS. IN INNER	PCS. IN OUTER	PCS. IN OUTER
GA1421	AMH1421054	72	44	0.025	20	400	25600

FINISH AVAILABLE : SAA, PAA
 NOTE: SUITABLE TO USE IN NIGHT LATCH MODEL LAL9001 TO LAL 9008



ALUMINIUM CYLINDER PULL

TECHNICAL DATA

NAME	DPG CODE	ITEM CODE	LENGTH	WIDTH	THICKNESS	SCREW NO.	WT./PCS	PCS. IN INNER	PCS. IN OUTER
EURO PROFILE	GA1423	AMH1423XXX	96	43	1.9	7	0.021	20	200
DUAL PROFILE	GA1425	AMH1425XXX	96	43	1.9	7	0.020	20	200

FINISH AVAILABLE : SAA, PAA

STAINLESS STEEL VICTORIAN CYLINDER DOOR PULL

TECHNICAL DATA

DPG CODE	ITEM CODE	LENGTH	WIDTH	WT./PCS	PCS. IN INNER	PCS. IN OUTER
850SS	SHIN850076	78	42	0.084	20	200

 FINISH AVAILABLE : EB, SATIN, MIRROR POLISHED
 NOTE: SUITABLE TO USE IN NIGHT LATCH MODEL LAL9001 TO LAL 9008

STAINLESS STEEL CYLINDER PULL

TECHNICAL DATA

DPG CODE	ITEM CODE	LENGTH	WIDTH	WT./PCS	PCS. IN INNER	PCS. IN OUTER
1421SS	SHIN1421064	89	42	0.084	20	400

 FINISH AVAILABLE : EB, SATIN, MIRROR POLISHED
 NOTE: SUITABLE TO USE IN NIGHT LATCH MODEL LAL9001 TO LAL 9008

STAINLESS STEEL CYLINDER PULL

TECHNICAL DATA

NAME	DPG CODE	ITEM CODE	LENGTH	WIDTH	THICKNESS	SCREW NO	WT./PCS	PCS. IN INNER	PCS. IN OUTER
EURP PROFILE	1423SS	SHIN1423X00	97	43	2.00	7	0.062	20	200
OWAL PROFILE	1425SS	SHIN1425X00	97	43	2.00	7	0.060	20	200

FINISH AVAILABLE : EB, SATIN, MIRROR POLISHED

CYLINDER PULL AND COVER

TECHNICAL DATA

DPG CODE	ITEM CODE	LENGTH	WIDTH	SCREW NO.	WT./PCS	PCS. IN INNER	PCS. IN OUTER
G2200	CMH2200120	120	55	6	0.235	10	80

FINISH AVAILABLE : EXB, DUROSIL, PEWTER

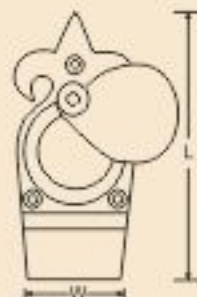
BRASS VICTORIAN OBLONG BELL PUSH

TECHNICAL DATA

DPG CODE	ITEM CODE	LENGTH	WIDTH	SCREW NO.	WT./PCS	PCS. IN INNER	PCS. IN OUTER
GB0881	BMH0881075	75	26	4	0.059	20	200

FINISH AVAILABLE : POLISHED & LACQUERED BRASS/CP/SNP



BLACK ANTIQUE BELL PUSH WITH FITTINGS & BELL PUSH PLATE

G1700

G1701

TECHNICAL DATA

DPG CODE	ITEM CODE	LENGTH	WIDTH	SCREW NO.	WT./PCS	PCS. IN INNER	PCS. IN OUTER
G1700	CMH1700122	132	33	7	0.110	20	160
G1701	CMH1701XXX	132	33	7	0.085	20	200

FINISH AVAILABLE : EXB, DUROSIL, PEWTER

BRASS GEORGIAN DOOR KNOCKER

TECHNICAL DATA

DPG CODE	ITEM CODE	LENGTH	WIDTH	SCREW NO.	WT./PCS	PCS. IN INNER	PCS. IN OUTER
GB2501	BMH2501165	178	77	M6	0.221	10	80

FINISH AVAILABLE : POLISHED & LACQUERED BRASS/CP/SNP

BRASS VICTORIAN URN DOOR KNOCKER

TECHNICAL DATA

DPG CODE	ITEM CODE	LENGTH	WIDTH	SCREW NO.	WT./PCS	PCS. IN INNER	PCS. IN OUTER
GB2502	BMH2502170	170	75	M6	0.178	10	100

FINISH AVAILABLE : POLISHED & LACQUERED BRASS/CP/SNP



BLACK ANTIQUE LION HEAD DOOR KNOCKER

TECHNICAL DATA

DPG CODE	ITEM CODE	LENGTH	WIDTH	SCREW NO.	WT./PCS	PCS. IN INNER	PCS. IN OUTER
G0120	CMIH0120150	155	93	M6	0.683	5	25

FINISH AVAILABLE : EXB, DUROSIL, PEWTER

BLACK ANTIQUE LION KNOCKER WITH SQUARE PLATE

TECHNICAL DATA

DPG CODE	ITEM CODE	LENGTH	WIDTH	SCREW NO.	WT./PCS	PCS. IN INNER	PCS. IN OUTER
G1402	CMIH1402150	154	94	M6	0.660	5	25

FINISH AVAILABLE : EXB, DUROSIL, PEWTER

BLACK ANTIQUE LION KNOCKER WITH ROUND PLATE

TECHNICAL DATA

DPG CODE	ITEM CODE	LENGTH	WIDTH	SCREW NO.	WT./PCS	PCS. IN INNER	PCS. IN OUTER
G1403	CMIH1403154	154	94	M6	0.650	5	25

FINISH AVAILABLE : EXB, DUROSIL, PEWTER



BLACK ANTIQUE LION LIGHT DOOR KNOCKER

TECHNICAL DATA

DPG CODE	ITEM CODE	LENGTH	WIDTH	SCREW NO.	WT./PCS	PCS. IN INNER	PCS. IN OUTER
G1401	GMH1401132	132	93	M6	0.495	5	30

FINISH AVAILABLE : EXB, DUROSIL, PEWTER

BLACK ANTIQUE FLEUR - DE - LYS RING KNOCKER

TECHNICAL DATA

DPG CODE	ITEM CODE	LENGTH	WIDTH	SCREW NO.	WT./PCS	PCS. IN INNER	PCS. IN OUTER
G1404	GMH1404125	124	93	M6	0.625	5	30

FINISH AVAILABLE : EXB, DUROSIL, PEWTER

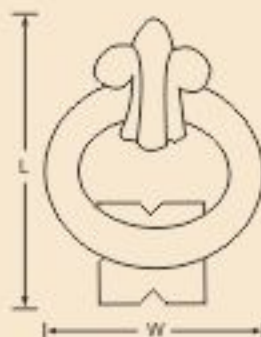
BLACK ANTIQUE RING KNOCKER

TECHNICAL DATA

DPG CODE	ITEM CODE	LENGTH	WIDTH	SCREW NO.	WT./PCS	PCS. IN INNER	PCS. IN OUTER
G0140	GMH0140158	126	94	M6	0.504	5	30

FINISH AVAILABLE : EXB, DUROSIL, PEWTER

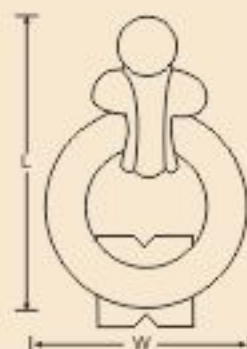

BRASS VICTORIAN HAT AND COAT HOOK

TECHNICAL DATA

DPG CODE	ITEM CODE	LENGTH	WIDTH	THICKNESS	SCREW NO.	WT/ PCS	PCS. IN INNER	PCS. IN OUTER	PCS. IN PALLET
GB0801	BMH0801125	126	30	2.6	6	0.072	10	200	6000

FINISH AVAILABLE : POLISHED & LACQUERED BRASS/CP/SNP

BRASS VICTORIAN HAT AND COAT HOOK HEAVY DUTY

TECHNICAL DATA

DPG CODE	ITEM CODE	LENGTH	WIDTH	THICKNESS	SCREW NO.	WT/ PCS	PCS. IN INNER	PCS. IN OUTER	PCS. IN PALLET
GB0806	BMH0806150	160	39	2.8	6	0.103	10	160	5760

FINISH AVAILABLE : POLISHED & LACQUERED BRASS/CP/SNP

BRASS VICTORIAN WARDROBE SINGLE HOOKS

TECHNICAL DATA

DPG CODE	ITEM CODE	LENGTH	WIDTH	THICKNESS	SCREW NO.	WT/ PCS	PCS. IN INNER	PCS. IN OUTER	PCS. IN PALLET
GB0811	BMH0811050	46	40	3.0	4	0.027	20	500	12000

FINISH AVAILABLE : POLISHED & LACQUERED BRASS/CP/SNP



BRASS VICTORIAN WARDROBE DOUBLE HOOK

TECHNICAL DATA

DPG CODE	ITEM CODE	HEIGHT	WIDTH	THICKNESS	SCREW NO.	WT/PCS	PCS. IN INNER	PCS. IN OUTER	PCS. IN PALLET
GB0812	BMH0812050	72	38	2.9	6	0.047	20	240	12000

FINISH AVAILABLE : POLISHED & LACQUERED BRASS/CP/SNP

BRASS CURTAIN TIE BACK ROSETTE & PLATE

TECHNICAL DATA

DPG CODE	ITEM CODE	LENGTH	WIDTH	WT/PCS	PCS. IN INNER	PCS. IN OUTER
GB0905	BMH0805038	38	32	0.021	50	500

FINISH AVAILABLE : POLISHED & LACQUERED BRASS/CP/SNP

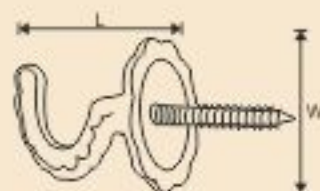
ALUMINIUM HAT & COAT HOOK

TECHNICAL DATA

DPG CODE	ITEM CODE	LENGTH	WIDTH	THICKNESS	SCREW NO.	WT/PCS	PCS. IN INNER	PCS. IN OUTER	PCS. IN PALLET
GA1481	BMHT481125	131	19	2.6	7	0.021	50	500	12000

FINISH AVAILABLE : SAA, PAA

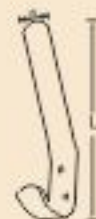

ALUMINIUM WARDROBE HOOK

TECHNICAL DATA

DPG CODE	ITEM CODE	LENGTH	WIDTH	THICKNESS	SCREW NO.	WT/PCS	PCS. IN INNER	PCS. IN OUTER	PCS. IN PALLET
GA1482	AMH1482050	46	19	2.5	6	0.006	50	500	19000

FINISH AVAILABLE : SAA, PAA

BLACK ANTIQUE HAT AND COAT HOOK SQUARE PLATE

TECHNICAL DATA

DPG CODE	ITEM CODE	LENGTH	WIDTH	SCREW NO.	WT/PCS	PCS. IN INNER	PCS. IN OUTER
B0400	CMH0400150	145	40	7	0.171	10	100

FINISH AVAILABLE : EXB, DUROSIL, PEWTER

BLACK ANTIQUE HAT & COAT HOOK OVAL PLATE

TECHNICAL DATA

DPG CODE	ITEM CODE	LENGTH	WIDTH	SCREW NO.	WT/PCS	PCS. IN INNER	PCS. IN OUTER
G0706	CMH0706125	138	36	7	0.132	10	140

FINISH AVAILABLE : EXB, DUROSIL, PEWTER



BLACK ANTIQUE ROBE HOOK

TECHNICAL DATA

DPG CODE	ITEM CODE	LENGTH	WIDTH	SCREW NO.	WT./PCS	PCS. IN INNER	PCS. IN OUTER
G0402A	CNIH402A050	60	40	7	0.110	10	200

FINISH AVAILABLE : EXB, DUROSIL, PEWTER

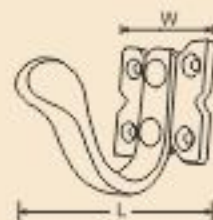
BLACK ANTIQUE ROBE HOOK DOUBLE

TECHNICAL DATA

DPG CODE	ITEM CODE	LENGTH	WIDTH	SCREW NO.	WT./PCS	PCS. IN INNER	PCS. IN OUTER
G0705	CMIH0705XXX	75	40	7	0.097	10	200

FINISH AVAILABLE : EXB, DUROSIL, PEWTER

MILD STEEL COWTIE HOOK

TECHNICAL DATA

DPG CODE	ITEM CODE	LENGTH	WIDTH	DIAMETER	WT./PCS	PCS. IN INNER	PCS. IN OUTER
G0710	CNIH071073	72	27	9.0	0.060	20	240

FINISH AVAILABLE : EXB, PEWTER



BLACK ANTIQUE CUPBOARD LATCH SET

TECHNICAL DATA

DPG CODE	ITEM CODE	LENGTH	WIDTH	SCREW NO.	WT/PCS	PCS. IN INNER	PCS. IN OUTER
G0492	CLAL0492070	52	76	8	0.226	10	80

FINISH AVAILABLE : EXB, DUROSIL, PEWTER



G0701 :

BLACK ANTIQUE ORNATE WARDROBE HOOK

G0494 :

BLACK ANTIQUE RING CABINET PULL (70MM)

G0702:

BLACK ANTIQUE BALL CURTAIN TIE BACK
GZC3001 : ZINC DIE CAST POLE HOOK

TECHNICAL DATA

ITEM CODE	LENGTH	WIDTH	DIA	SCREW NO.	WT/PCS	PCS. IN INNER	PCS. IN OUTER
ZMH3001XXX	112	72	27	4	0.091	10	100

FINISH AVAILABLE : ELECTRO BRASS, CHROME

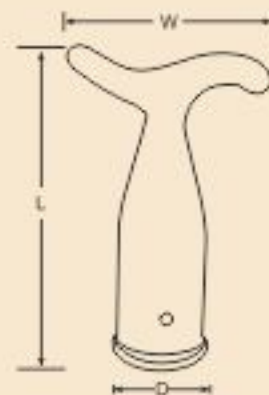
BRASS POLE HOOK

TECHNICAL DATA

DPG CODE	ITEM CODE	LENGTH	WIDTH	DIA	SCREW NO.	WT/PCS	PCS. IN INNER	PCS. IN OUTER
G80821	BMH0821112	112	74	28	4	0.123	10	120

FINISH AVAILABLE : POLISHED & LACQUERED BRASS/CP/SNP



BRASS RING FLUSH PULL

TECHNICAL DATA

DPG CODE	ITEM CODE	LENGTH	WIDTH	THICKNESS	SCREW NO.	WT./PCS	PCS. IN INNER	PCS. IN OUTER
GB0931	BMH0931050	53	38	2.2	6	0.053	20	200
GB0932	BMH0931063	64	50	2.5	6	0.104	10	160

FINISH AVAILABLE : POLISHED & LACQUERED BRASS/CP/SNP

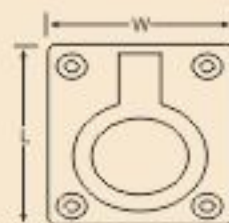
STAINLESS STEEL FLUSH PULL (OVAL SHAPE)

TECHNICAL DATA

DPG CODE	ITEM CODE	LENGTH	WIDTH	THICKNESS	SCREW NO.	WT./PCS	PCS. IN INNER	PCS. IN OUTER
SS455A	SMH455A120	120	41	2.00	6	0.052	20	200

FINISH AVAILABLE : EB, SATIN, MIRROR POLISHED

STAINLESS STEEL FLUSH PULL (OVAL SHAPE) CONCEALED FIXING

TECHNICAL DATA

DPG CODE	ITEM CODE	LENGTH	WIDTH	THICKNESS	SCREW NO.	WT./PCS	PCS. IN INNER	PCS. IN OUTER
SS456A	SMH456A120	120	41	2.00	6	0.052	20	200

FINISH AVAILABLE : EB, SATIN, MIRROR POLISHED



STAINLESS STEEL FLUSH PULL (RECTANGULAR SHAPE) CONCEALED FIXING

TECHNICAL DATA

DPG CODE	ITEM CODE	LENGTH	WIDTH	THICKNESS	SCREW NO.	WT./PCS	PCS. IN INNER	PCS. IN OUTER
455SS	SMHD455100	102	51	2.00	6	0.060	20	200

FINISH AVAILABLE : EB, SATIN, MIRROR POLISHED

BRASS FLUSH PULL

TECHNICAL DATA

DPG CODE	ITEM CODE	LENGTH	WIDTH	THICKNESS	SCREW NO.	WT./PCS	PCS. IN INNER	PCS. IN OUTER
GB0455A	BMHD456085	100	38	1.0	4	0.037	20	400

FINISH AVAILABLE : POLISHED & LACQUERED BRASS/CP/SNP

BRASS FLUSH PULL

TECHNICAL DATA

DPG CODE	ITEM CODE	LENGTH	WIDTH	THICKNESS	SCREW NO.	WT./PCS	PCS. IN INNER	PCS. IN OUTER
GB0459	BMHD459089	87	27	2.7	4	0.060	10	200

FINISH AVAILABLE : POLISHED & LACQUERED BRASS/CP/SNP



STAINLESS STEEL DRAWER PULL

TECHNICAL DATA

DPG CODE	ITEM CODE	O.D DIA	LD DIA	SCREW NO.	WT./PCS	PCS. IN INNER	PCS. IN OUTER
952SS	SMIH0952090	90	69	6	0.096	10	100

FINISH AVAILABLE : EB, SATIN, MIRROR POLISHED

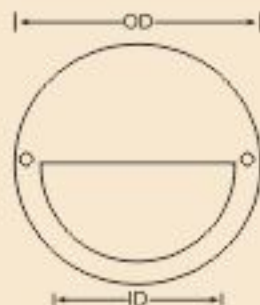
BRASS HOODED DRAWER PULL

TECHNICAL DATA

DPG CODE	ITEM CODE	LENGTH	WIDTH	SCREW NO.	WT./PCS	PCS. IN INNER	PCS. IN OUTER
G80951	SMIH0951080	100	40	6	0.079	20	200

FINISH AVAILABLE : POLISHED & LACQUERED BRASS/CP/SNP

ALUMINIUM FLUSH PULL

TECHNICAL DATA

DPG CODE	ITEM CODE	LENGTH	WIDTH	SCREW NO.	WT./PCS	PCS. IN INNER	PCS. IN OUTER
GA1451	AMH1451090	89	42	4	0.020	10	200

FINISH AVAILABLE : SAA, PAA



BLACK ANTIQUE ORNAMENT DRAWER PULL

TECHNICAL DATA

DPG CODE	ITEM CODE	LENGTH	WIDTH	SCREW NO.	WT./PCS	PCS. IN INNER	PCS. IN OUTER
G1601	CMH1601100	102	44	7	0.115	10	160

FINISH AVAILABLE : EXB, DUROSIL, PEWTER

BLACK ANTIQUE DRAWER PULL

TECHNICAL DATA

DPG CODE	ITEM CODE	LENGTH	WIDTH	SCREW NO.	WT./PCS	PCS. IN INNER	PCS. IN OUTER
G0497	CMH0497089	94	42	7	0.102	10	100

FINISH AVAILABLE : EXB, DUROSIL, PEWTER

STAINLESS STEEL TOILET ROLL HOLDER

TECHNICAL DATA

DPG CODE	ITEM CODE	LENGTH	WIDTH	THICKNESS	SCREW NO.	WT./PCS	PCS. IN INNER	PCS. IN OUTER	PCS. IN PALLET
1483SS	SMH1483XXX	135	81	2.0	8	0.053	10	100	2400

FINISH AVAILABLE : EB, SATIN, MIRROR POLISHED

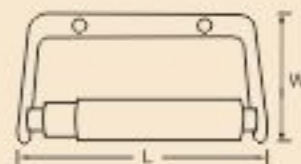

ALUMINIUM TOILET ROLL HOLDER

TECHNICAL DATA

DPG CODE	ITEM CODE	LENGTH	WIDTH	THICKNESS	SCREW NO.	WT/PCS	PCS. IN INNER	PCS. IN OUTER	PCS. IN PALLET
GA1483	AMH1483XXX	135	81	2.7	8	0.053	10	100	2400

FINISH AVAILABLE : SAA, PAA

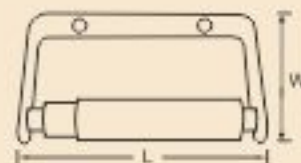
PLASTIC TOILET ROLLER

TECHNICAL DATA

DPG CODE	ITEM CODE	LENGTH	BIG DIA.	SMALL DIA.	WT/PCS	PCS. IN INNER	PCS. IN OUTER
GA1483A	PMH1483XXX	140	22	18	0.015	10	100

FINISH AVAILABLE : BLACK

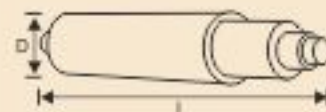
GFX5012 : MILD STEEL SCREW EYE

TECHNICAL DATA

ITEM CODE	SIZE	LENGTH	WIDTH	WIRE DIA.	WT/PCS	PCS. IN INNER	PCS. IN OUTER
MFNR5012075	3"	76	35	7.0	0.040	10	300
MFNR5012100	4"	102	35	7.0	0.050	10	300
MFNR5012125	5"	127	35	7.0	0.060	10	300
MFNR5012150	6"	152	35	7.0	0.071	10	200

FINISH AVAILABLE : B2P



GFX5001 : MILD STEEL SCREW HOOK

TECHNICAL DATA

ITEM CODE	SIZE	LENGTH	WIDTH	WIRE DIA	WT/ PCS	PCS. IN INNER	PCS. IN OUTER
MFNR5012075	3"	76	30	4.5	0.014	25	100

FINISH AVAILABLE : BZP

GPL0401 : PLASTIC SCREW CUP & CAP

TECHNICAL DATA

ITEM CODE	BASE DIA D1	CAP DIA D2	WT/ PCS	PCS. IN INNER	PCS. IN OUTER	PCS. IN PALLET
PMH0401XXX	12.0	11.0	0.0003	1000	5000	225000

COLOUR AVAILABLE : WHITE, BROWN, BLACK, MAGNOLIA, GREY

GPL0051 : PLASTIC CONNECTING BOLT

TECHNICAL DATA

ITEM CODE	LENGTH	DIAMETER	BOLT	WT/PCS	PCS. IN INNER	PCS. IN OUTER
PMH0051040	47	16	M6	0.002	1000	5000

COLOUR AVAILABLE : WHITE, BROWN, BLACK, MAGNOLIA, GREY

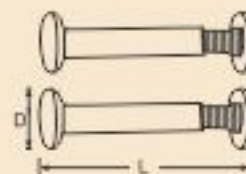

GPL0201 : PLASTIC SHELF BRACKET WITH NAILS

TECHNICAL DATA

ITEM CODE	LENGTH	WIDTH	WIRE DIA	WT./PCS	PCS. IN INNER	PCS. IN OUTER
PMIH0201XXX	15	13	6.5	0.0004	1000	5000

COLOUR AVAILABLE : WHITE, BROWN, BLACK, MAGNOLIA, GREY

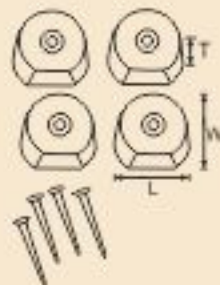
GPL0301 : PLASTIC KD BLOCKS

TECHNICAL DATA

ITEM CODE	LENGTH	WIDTH	THICKNESS	SCREW NO.	WT./PCS	PCS. IN INNER	PCS. IN OUTER
PMIH0301XXX	35	25	12.5	6	0.008	100	1000

COLOUR AVAILABLE : WHITE, BROWN, BLACK, MAGNOLIA, GREY

GPL0321 : PLASTIC MODESTY BLOCKS

TECHNICAL DATA

ITEM CODE	LENGTH	WIDTH	THICKNESS	SCREW NO.	WT./PCS	PCS. IN INNER	PCS. IN OUTER
PMIH0321XXX	35	13.5	13	6	0.004	100	1000

COLOUR AVAILABLE : WHITE, BROWN, BLACK, MAGNOLIA, GREY

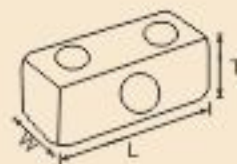

GPL0061 : PLASTIC GLASS CLIP

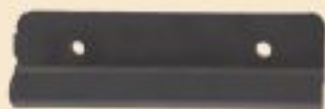

TECHNICAL DATA

ITEM CODE	LENGTH	WIDTH	THICKNESS	WT./PCS	PCS. IN INNER	PCS. IN OUTER
PMIH0061XXX	46	15	3.0	0.002	1000	5000

COLOUR AVAILABLE : BLACK, BROWN

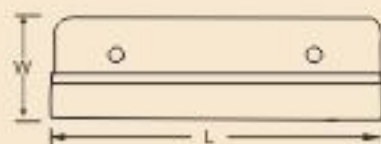

BRASS COUNTER FLAP CATCH



TECHNICAL DATA

DPG CODE	ITEM CODE	LENGTH	WIDTH	THICKNESS	SCREW NO.	WT./PCS	PCS. IN INNER	PCS. IN OUTER
GB3171	BMHS171085	86	23	3.5	7	0.171	10	100

FINISH AVAILABLE : POLISHED & LACQUERED BRASS/CP/SNP

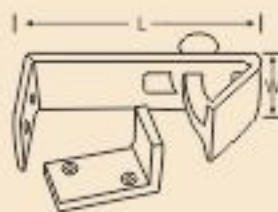



Garg
Locks



SECONDARY SECURITY

Visit us at : www.garglocks.com



ADSZ0001 : ZINC DIE CAST SECURITY BOLT (DOOR GUARD)



TECHNICAL DATA

ITEM CODE	LENGTH	WIDTH	THICKNESS	SCREW NO.	WT./PCS	PCS. IN INNER	PCS. IN OUTER
ZADS0001XXX	116	59	2.4	5	0.100	5	30

FINISH AVAILABLE : CP, NP, EB, SCP

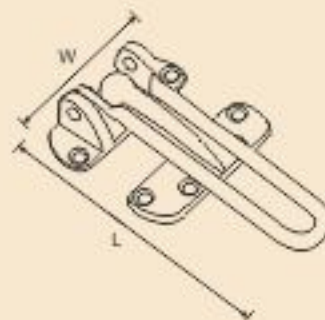

ADSM009 : MILD STEEL DOOR CHAIN



TECHNICAL DATA

ITEM CODE	LENGTH	WIDTH	THICKNESS	SCREW NO.	WT./PCS	PCS. IN INNER	PCS. IN OUTER
MADS0009040	44	38	3.0	6	0.135	10	100

FINISH AVAILABLE : BZP, NP, EB, CP, SCP

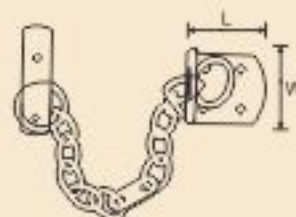

6300 : MILD STEEL SECURITY DOOR CHAIN



TECHNICAL DATA

ITEM CODE	LENGTH	WIDTH	THICKNESS	SCREW NO.	WT./PCS	PCS. IN INNER	PCS. IN OUTER
MSCF6300100	85	34	1.9	6	0.123	10	100

FINISH AVAILABLE : BZP, NP, EB, CP, SCP

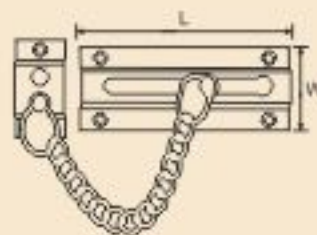

GB6300 BRASS DOOR CHAIN



TECHNICAL DATA

DPG CODE	ITEM CODE	LENGTH	WIDTH	THICKNESS	SCREW NO.	WT./PCS	PCS. IN INNER	PCS. IN OUTER
GB6300	BSCF6300085	85	35	2.2	4	0.117	10	100

FINISH AVAILABLE : POLISHED & LACQUERED BRASS, CP, SNP

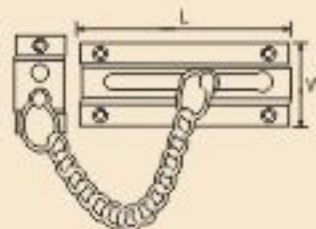

G0802 BLACK ANTIQUE SECURITY LATCH (DOOR CHAIN)



TECHNICAL DATA

DPG CODE	ITEM CODE	LENGTH	WIDTH	SCREW NO.	WT./PCS	PCS. IN INNER	PCS. IN OUTER
G0802	CIRN0802133	125	78	4	0.278	5	60

FINISH AVAILABLE : EXB, DUROSIL, PEWTER

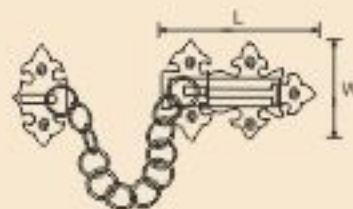

70010 : HINGE BOLT



TECHNICAL DATA

ITEM CODE	SIZE	LENGTH	DIA	PLATE L1XW	SCREW NO.	WT./SET	SETS IN INNER	SETS IN OUTER
MIRN700100X	2"	78	12.5	51X29	6	0.102	10	200

FINISH AVAILABLE : BZP, NP, EB

