



Ironmongery



Note

1. _____
2. _____
3. _____
4. _____
5. _____
6. _____
7. _____
8. _____
9. _____
10. _____
11. _____
12. _____
13. _____
14. _____
15. _____
16. _____
17. _____
18. _____
19. _____
20. _____

923SS : STAINLESS STEEL TOWER BOLT

TECHNICAL DATA

ITEM CODE	SIZE	LENGTH	WIDTH	SHOOT DIA	SCREW NO.	WT/PCS	PCS. IN INNER	PCS. IN OUTER	PCS. IN PALLET
SIRN0923075	3"	75	33	10	4	0.084	10	240	8160
SIRN0923100	4"	100	33	10	4	0.130	10	160	5440
SIRN0923150	6"	150	33	10	4	0.158	10	140	4200
SIRN0923200	8"	200	33	10	4	0.216	10	100	3000
SIRN0923250	10"	250	33	10	6	0.252	10	80	1920
SIRN0923300	12"	300	33	10	6	0.307	10	60	1800

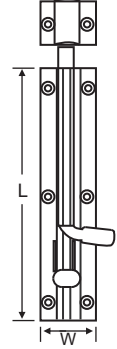
FINISH AVAILABLE - EB, SATIN, MIRROR POLISHED

STAINLESS STEEL BARREL BOLT (LIGHT)

TECHNICAL DATA

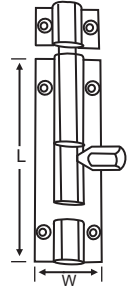
ITEM CODE	SIZE	LENGTH	WIDTH	SHOOT DIA	SCREW NO.	WT/PCS	PCS. IN INNER	PCS. IN OUTER	PCS. IN PALLET
SIRN0887038	1.5"	40	27	6.9	4	0.042	10	400	16000
SIRN0888050	2"	50	27	6.9	4	0.047	10	400	16000
SIRN0889065	2.5"	65	27	6.9	4	0.056	10	340	12240
SIRN0890075	3"	75	27	6.9	4	0.066	10	300	10800
SIRN0891100	4"	100	27	6.9	4	0.086	10	200	9000
SIRN0892150	6"	150	27	6.9	4	0.124	10	160	6400

FINISH AVAILABLE - EB, SATIN, MIRROR POLISHED

STAINLESS STEEL BARREL BOLT (HEAVY)

TECHNICAL DATA

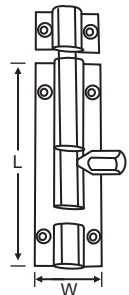
ITEM CODE	SIZE	LENGTH	WIDTH	SHOOT DIA	SCREW NO.	WT/PCS	PCS. IN INNER	PCS. IN OUTER	PCS. IN PALLET
SIRN0891100	4"	100	38	10.8	6	0.154	10	120	5400
SIRN0893150	6"	152	38	10.8	6	0.218	10	80	3120
SIRN0894200	8"	200	38	10.8	6	0.282	10	60	2700
SIRN0895250	10"	250	38	10.8	6	0.346	10	60	1980

FINISH AVAILABLE - EB, SATIN, MIRROR POLISHED

STAINLESS STEEL BARREL BOLT NECKED (LIGHT)

TECHNICAL DATA

ITEM CODE	SIZE	LENGTH	WIDTH	SHOOT DIA	SCREW NO.	WT/PCS	PCS. IN INNER	PCS. IN OUTER	PCS. IN PALLET
SIRN888N050	2"	50	27	6.9	4	0.047	10	400	16000
SIRN889N065	2.5"	65	27	6.9	4	0.056	10	340	12240
SIRN890N075	3"	75	27	6.9	4	0.066	10	300	10800
SIRN891N100	4"	100	27	6.9	4	0.086	10	200	9000
SIRN892N150	6"	150	27	6.9	4	0.124	10	160	6400

FINISH AVAILABLE - EB, SATIN, MIRROR POLISHED

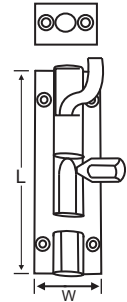
STAINLESS STEEL BARREL BOLT NECKED (HEAVY)

TECHNICAL DATA

ITEM CODE	SIZE	LENGTH	WIDTH	SHOOT DIA	SCREW NO.	WT/PCS	PCS. IN INNER	PCS. IN OUTER	PCS. IN PALLET
SIRN0791100	4"	100	38	10	6	0.154	10	120	5400
SIRN893N150	6"	152	38	10	6	0.218	10	80	3120
SIRN894N200	8"	200	38	10	6	0.282	10	60	2700
SIRN895N250	10"	250	38	10	6	0.346	10	60	1980

FINISH AVAILABLE - EB, SATIN, MIRROR POLISHED

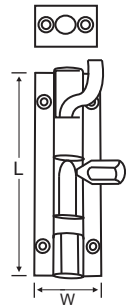
923A : MILD STEEL TOWER BOLT

TECHNICAL DATA

ITEM CODE	SIZE	LENGTH	WIDTH	THICKNESS	SHOOT DIA	SCREW NO.	WT/PCS	PCS. IN INNER	PCS. IN OUTER	PCS. IN PALLET
MIRN923A075	3"	85	38	0.8	10	6	0.107	10	200	8000
MIRN923A100	4"	110	38	0.8	10	6	0.135	10	120	5400
MIRN923A125	5"	135	38	0.8	10	6	0.150	10	100	4800
MIRN923A150	6"	160	38	0.8	10	6	0.192	10	80	4000
MIRN923A200	8"	210	45	1.0	12	6	0.370	10	50	2000
MIRN923A250	10"	260	45	1.0	12	6	0.449	10	40	1440
MIRN923A300	12"	310	45	1.0	12	6	0.531	10	30	1200

FINISH AVAILABLE - EXB, TEXTURE BLK, EXW, ZP, DUROSIL, EVERBLACK , HSG

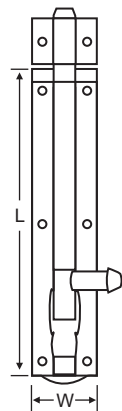

923N : MILD STEEL NECKED TOWER BOLT



TECHNICAL DATA

ITEM CODE	SIZE	LENGTH	WIDTH	SHOOT DIA	SCREW NO.	WT/PCS	PCS. IN INNER	PCS. IN OUTER	PCS. IN PALLET
MIRN923N100	4"	110	38	10	6	0.126	10	120	5400
MIRN923N150	6"	160	38	10	6	0.188	10	80	4000
MIRN923N200	8"	210	45	12	6	0.348	10	50	2000
MIRN923N250	10"	260	45	12	6	0.467	10	40	1440

FINISH AVAILABLE - EXB, TEXTURE BLK, EXW, ZP, DUROSIL, EVERBLACK, HSG

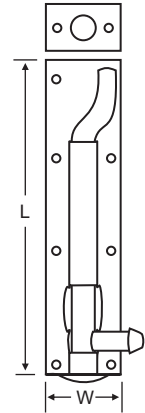

923SA : MILD STEEL BARREL BOLT



TECHNICAL DATA

ITEM CODE	SIZE	LENGTH	WIDTH	THICKNESS	SHOOT DIA	BOLT	WT/PCS	PCS. IN INNER	PCS. IN OUTER	PCS. IN PALLET
MIRN923SA100	4"	117	43	1.6	12	M5	0.183	10	100	4200
MIRN923SA150	6"	167	43	1.6	12	M5	0.264	10	80	2560
MIRN923SA200	8"	217	43	1.6	12	M5	0.375	10	60	1920
MIRN923SA250	10"	267	43	1.6	12	M5	0.426	10	40	1920

FINISH AVAILABLE - EXB, TEXTURE BLK, EXW, ZP, DUROSIL, EVERBLACK, HSG

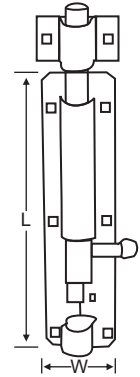

923H : MILD STEEL SECTIONAL TOWER BOLT



TECHNICAL DATA

ITEM CODE	SIZE	LENGTH	WIDTH	SHOOT DIA	SCREW NO.	WT/PCS	PCS. IN INNER	PCS. IN OUTER	PCS. IN PALLET
MIRN923H075	3"	75	33	10	6	0.135	10	200	6000
MIRN923H100	4"	100	33	10	6	0.165	10	150	5400
MIRN923H125	5"	125	33	10	6	0.210	10	100	3200
MIRN923H150	6"	150	33	10	6	0.240	10	80	2560
MIRN923H150	6"	150	38	12	6	0.280	10	50	2500
MIRN923H200	8"	200	33	10	6	0.420	10	40	2000
MIRN923H200	8"	200	38	12	6	0.446	10	40	1600

FINISH AVAILABLE - EXB, TEXTURE BLK, EXW, ZP, DUROSIL, EVERBLACK, HSG

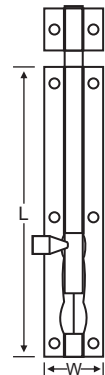

922A MILD STEEL BUDGET STRAIGHT BARREL BOLT HEX KNOB



TECHNICAL DATA

ITEM CODE	SIZE	LENGTH	WIDTH	SHOOT DIA	SCREW NO.	WT/PCS	PCS. IN INNER	PCS. IN OUTER	PCS. IN PALLET
MIRN922A038	1.5"	40	27	6.9	4	0.042	10	400	16000
MIRN922A050	2"	50	27	6.9	4	0.047	10	400	16000
MIRN922A065	2.5"	65	27	6.9	4	0.055	10	340	12240
MIRN922A075	3"	75	27	6.9	4	0.065	10	300	10800
MIRN922A100	4"	100	27	6.9	4	0.085	10	200	9000
MIRN922A150	6"	150	27	6.9	4	0.125	10	160	6400

FINISH AVAILABLE - BZP, EB, SAT, PCP

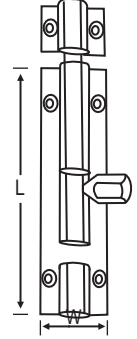

922N MILD STEEL BUDGET BARREL BOLT NECKED HEX KNOB



TECHNICAL DATA

ITEM CODE	SIZE	LENGTH	WIDTH	SHOOT DIA	SCREW NO.	WT/PCS	PCS. IN INNER	PCS. IN OUTER	PCS. IN PALLET
MIRN922N063	2.5"	65	27	6.9	4	0.055	10	340	12240
MIRN922N075	3"	75	27	6.9	4	0.065	10	300	10800
MIRN922N100	4"	100	27	6.9	4	0.085	10	200	9000
MIRN922N150	6"	150	27	6.9	4	0.125	10	160	6400

FINISH AVAILABLE - BZP, EB, SAT, PCP

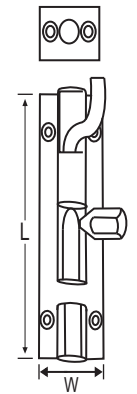

1258 : MILD STEEL BARREL BOLT



TECHNICAL DATA

ITEM CODE	SIZE	LENGTH	WIDTH	THICKNESS	SCREW NO.	SHOOT DIA	WT/PCS	PCS. IN INNER	PCS. IN OUTER	PCS. IN PALLET
MIRN1258038	1.5"	35	39.5	1.2	7	7.8	0.050	20	400	12800
MIRN1258050	2"	45	39.5	1.2	7	7.8	0.060	20	300	10800
MIRN1258050	2"	55	39.5	1.2	7	7.8	0.070	10	200	9000
MIRN1258100	4"	77	39.5	1.2	7	7.8	0.090	10	200	9000

FINISH AVAILABLE - EXB, TEXTURE BLK, EXW, ZP, DUROSIL, EVERBLACK, HSG

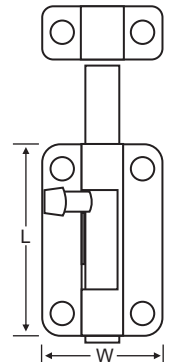

1258H : MILD STEEL HEAVY BARREL BOLT

TECHNICAL DATA

ITEM CODE	SIZE	LENGTH	WIDTH	THICKNESS	SCREW NO.	SHOOT DIA	WT/PCS	PCS. IN INNER	PCS. IN OUTER	PCS. IN PALLET
MIRN1258075	3"	83	42	1.6	7	10	0.150	10	100	4800
MIRN1258100	4"	114	42	1.6	7	10	0.200	10	100	3600

FINISH AVAILABLE - EXB, TEXTURE BLK, EXW, ZP, DUROSIL, EVERBLACK, HSG

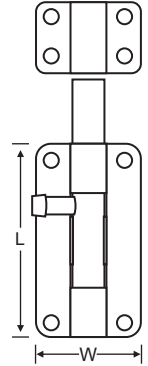
BRASS HEAVY DUTY STRAIGHT BARREL BOLT-HEX KNOB

TECHNICAL DATA

DPG CODE	ITEM CODE	LENGTH	WIDTH	THICKNESS	SHOOT DIA	SCREW NO.	WT/PCS	PCS. IN INNER	PCS. IN OUTER	PCS. IN PALLET
GB0893	BMIH0893150	152	30	1.2	8.4	6	0.174	10	100	4000
GB0894	BMIH0894200	205	30	1.2	8.8	6	0.256	5	80	2880
GB0895	BMIH0895250	250	30	1.2	8.8	6	0.338	5	60	2160
GB0896	BMIH0896300	300	30	1.2	8.8	6	0.420	5	40	1600

FINISH AVAILABLE - POLISHED & LACQUERED BRASS/CP/SNP

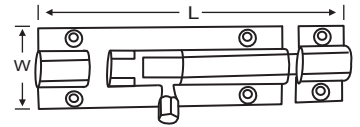
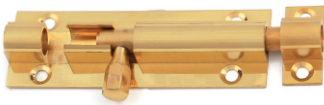
BRASS STRAIGHT BARREL BOLT HEX KNOB

TECHNICAL DATA

DPG CODE	ITEM CODE	LENGTH	WIDTH	THICKNESS	SHOOT DIA	SCREW NO.	WT/PCS	PCS. IN INNER	PCS. IN OUTER	PCS. IN PALLET
GB0887	BMIH0887038	38	25	0.9	6.8	4	0.036	20	400	16000
GB0888	BMIH0888050	50	25	0.9	6.8	4	0.039	20	400	16000
GB0889	BMIH0889065	63	25	0.9	6.8	4	0.049	20	300	12000
GB0890	BMIH0890075	75	25	0.9	6.8	4	0.060	10	250	10000
GB0891	BMIH0891100	100	25	0.9	6.8	4	0.082	10	200	9000
GB0892	BMIH0892150	150	25	0.9	6.8	4	0.123	10	140	5600

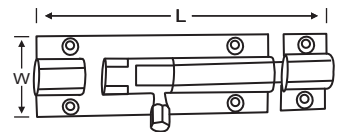
FINISH AVAILABLE - POLISHED & LACQUERED BRASS/CP/SNP



BRASS NECKED BARREL BOLT HEX KNOB

TECHNICAL DATA

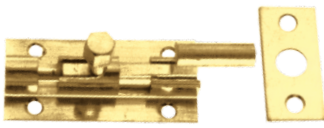

DPG CODE	ITEM CODE	LENGTH	WIDTH	THICKNESS	SHOOT DIA	SCREW NO.	WT/ PCS	PCS. IN INNER	PCS. IN OUTER	PCS. IN PALLET
GB0889N	BMIH889N065	63	25	0.9	6.8	4	0.051	20	300	12000
GB0897	BMIH0897075	75	25	0.9	6.8	4	0.062	10	250	10000
GB0898	BMIH0898100	100	25	0.9	6.8	4	0.080	10	200	9000
GB0899	BMIH0899150	150	25	0.9	6.8	4	0.123	10	140	5600

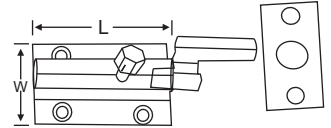

FINISH AVAILABLE - POLISHED & LACQUERED BRASS/CP/SNP

BRASS SHAPED BARREL BOLT

TECHNICAL DATA



DPG CODE	ITEM CODE	LENGTH	WIDTH	THICKNESS	SHOOT DIA	SCREW NO.	WT/ PCS	PCS. IN INNER	PCS. IN OUTER	PCS. IN PALLET
GB0914	BMIH0914090	95	30	1.3	8.3	6	0.120	10	120	6000

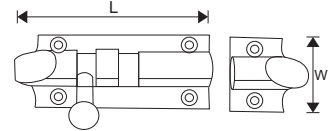

FINISH AVAILABLE - POLISHED & LACQUERED BRASS/CP/SNP

BRASS SHAPED NECKED BARREL BOLT

TECHNICAL DATA



DPG CODE	ITEM CODE	LENGTH	WIDTH	THICKNESS	SHOOT DIA	SCREW NO.	WT/ PCS	PCS. IN INNER	PCS. IN OUTER	PCS. IN PALLET
GB0915	BMIH0915090	95	30	1.3	8.3	6	0.105	10	120	6000

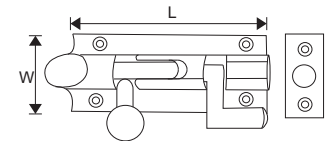

FINISH AVAILABLE - POLISHED & LACQUERED BRASS/CP/SNP

TOP SLIDE BOLT

TECHNICAL DATA

DPG CODE	ITEM CODE	LENGTH	WIDTH	SCREW NO.	WT/ PCS	PCS. IN INNER	PCS. IN OUTER	PCS. IN PALLET
GB0908	BMIH0908115	111	24	6	0.088	10	200	9000
GB0909	BMIH0909150	145	32	6	0.188	10	100	4000
GB0910	BMIH0910195	195	40	6	0.294	5	60	2400

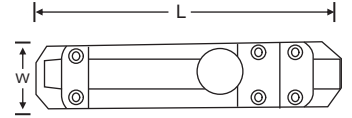

FINISH AVAILABLE - POLISHED & LACQUERED BRASS/CP/SNP

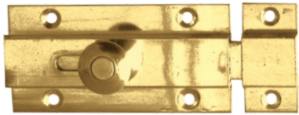
BRASS SPRING TOWER BOLT 3" (75mm)

GB0901
BRASS OVAL SHAPED TOWER BOLT 4"

GB0902
BRASS BARREL TOWER BOLT 4"

GB0903
BRASS GEORGIAN BARREL BOLT

**GB0904 (4")
GB0906 (6")**
BRASS STRAIGHT TOWER BOLT

**GB0911 (4")
GB0912 (6")**
ALUMINIUM BARREL BOLT

TECHNICAL DATA

DPG CODE	ITEM CODE	LENGTH	WIDTH	THICKNESS	SHOOT DIA	SCREW NO.	WT/ PCS	PCS. IN INNER	PCS. IN OUTER	PCS. IN PALLET
GA1601	AIRN1601050	50	25	0.7	7.5	4	0.023	10	450	10800
GA1602	AIRN1602063	63	25	0.9	7.5	4	0.030	10	400	10800
GA1603	AIRN1603075	75	25	0.9	7.5	4	0.036	10	300	10800
GA1604	AIRN1604100	100	25	0.9	7.5	4	0.048	10	250	9000
GA1605	AIRN1605150	150	25	1.0	7.5	4	0.070	10	160	5120

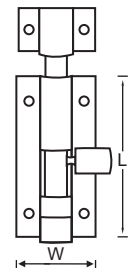

Finish Available : SAA

ALUMINIUM NECKED BARREL BOLT



TECHNICAL DATA

DPG CODE	ITEM CODE	LENGTH	WIDTH	THICKNESS	SCREW NO.	WT/ PCS	PCS. IN INNER	PCS. IN OUTER	PCS. IN PALLET
GA1651	AIRN1651075	75	25	0.9	4	0.035	10	300	10800
GA1652	AIRN1652100	100	25	0.9	4	0.047	10	250	9000
GA1653	AIRN1653150	150	25	1.0	4	0.070	10	160	5120

Finish Available : SAA

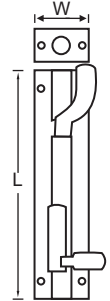

BLACK ANTIQUE STRAIGHT DOOR BOLT WITH KNOB



TECHNICAL DATA

DPG CODE	ITEM CODE	SIZE	LENGTH	WIDTH	SCREW NO.	WT/ PCS	PCS. IN INNER	PCS. IN OUTER	PCS. IN PALLET
G0366	CIRN0366075	3"	86	31	7	0.130	10	140	5040
G0368	CIRN0368100	4"	102	33	7	0.160	10	100	4000

FINISH AVAILABLE : EXB, DUROSIL

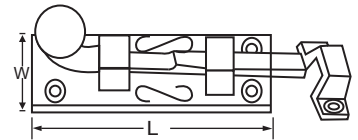

BLACK ANTIQUE NECKED DOOR BOLT WITH KNOB



TECHNICAL DATA

DPG CODE	ITEM CODE	SIZE	LENGTH	WIDTH	SCREW NO.	WT/ PCS	PCS. IN INNER	PCS. IN OUTER	PCS. IN PALLET
G0374	CIRN0374075	3"	78	31	6	0.148	10	120	4800

FINISH AVAILABLE : EXB, DUROSIL

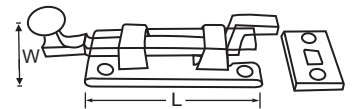

BLACK ANTIQUE CURLY TAIL DOOR BOLT



TECHNICAL DATA

DPG CODE	ITEM CODE	SIZE	LENGTH	WIDTH	SCREW NO.	WT/ PCS	PCS. IN INNER	PCS. IN OUTER	PCS. IN PALLET
G0376	CIRN0376075	3"	85	31	7	0.133	10	140	5040
G0377	CIRN0377100	4"	102	33	7	0.143	10	120	4320

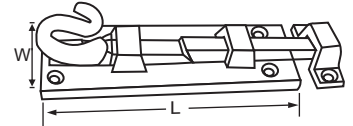

FINISH AVAILABLE : EXB, DUROSIL

BLACK ANTIQUE CURLY TAIL NECKED DOOR BOLT



TECHNICAL DATA

DPG CODE	ITEM CODE	SIZE	LENGTH	WIDTH	SCREW NO.	WT/ PCS	PCS. IN INNER	PCS. IN OUTER	PCS. IN PALLET
G0378	CIRN0378075	3"	78	31	7	0.132	10	120	5400

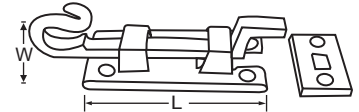

FINISH AVAILABLE : EXB, DUROSIL

BLACK ANTIQUE SCROLL STRAIGHT DOOR BOLT



TECHNICAL DATA

DPG CODE	ITEM CODE	SIZE	LENGTH	WIDTH	SCREW NO.	WT/ PCS	PCS. IN INNER	PCS. IN OUTER	PCS. IN PALLET
G0900	CIRN0900100	4"	110	40	7	0.154	5	100	4000
G0901	CIRN0901125	5"	115	45	7	0.204	5	80	2880
G0901A	CIRN901A150	6"	163	45	7	0.330	5	60	2160
G0902	CIRN0903200	8"	185	52	8	0.456	5	40	1440

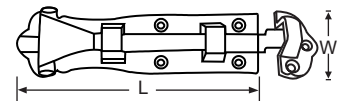

FINISH AVAILABLE : EXB, DUROSIL

BLACK ANTIQUE SCROLL NECKED DOOR BOLT
TECHNICAL DATA

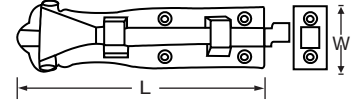

DPG CODE	ITEM CODE	SIZE	LENGTH	WIDTH	SCREW NO.	WT/ PCS	PCS. IN INNER	PCS. IN OUTER	PCS. IN PALLET
G0900N	CIRN900N100	4"	112	40	7	0.223	5	80	3200
G0901N	CIRN901N125	5"	120	45	7	0.242	5	80	3200
G0901AN	CIRN902N150	6"	163	45	7	0.330	5	60	2160
G0902N	CIRN902N200	8"	185	52	8	0.460	5	40	1600

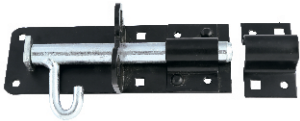

FINISH AVAILABLE : EXB, DUROSIL

1A : MILD STEEL HEAVY PADBOLT, BRENTON PATTERN
TECHNICAL DATA

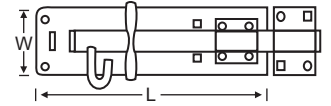
ITEM CODE	SIZE	SHOOT LENGTH	LENGTH	WIDTH	THICKNESS	SCREW NO.	SHOOT DIA	WT/ PCS	PCS. IN INNER	PCS. IN OUTER	PCS. IN PALLET
MIRN001A150	6"	151	171	57	1.9	6	16	0.533	5	40	1360
MIRN001A200	8"	201	222	57	1.9	6	16	0.654	5	35	945
MIRN001A250	10"	251	275	57	1.9	6	16	0.772	5	25	900
MIRN001A300	12"	301	322	57	1.9	6	16	0.907	5	20	720



FINISH AVAILABLE - EXB, TEXTURE BLK, EXW, ZP, DUROSIL, EVERBLACK, HSG

2A : MILD STEEL MEDIUM PADBOLT, BRENTON PATTERN
TECHNICAL DATA

ITEM CODE	SIZE	SHOOT LENGTH	LENGTH	WIDTH	THICKNESS	SCREW NO.	SHOOT DIA	WT/ PCS	PCS. IN INNER	PCS. IN OUTER	PCS. IN PALLET
MIRN002A100	4"	101	120	45	1.5	6	12	0.242	5	80	2880
MIRN002A150	6"	152	172	45	1.5	6	12	0.305	5	60	2040
MIRN002A200	8"	202	220	45	1.5	6	12	0.385	5	50	1200
MIRN002A250	10"	252	272	45	1.5	6	12	0.452	5	40	1080
MIRN002A300	12"	302	322	45	1.5	6	12	0.530	5	35	980

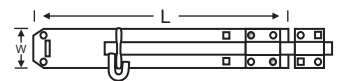

FINISH AVAILABLE - EXB, TEXTURE BLK, EXW, ZP, DUROSIL, EVERBLACK, HSG

4A : MILD STEEL OVAL PAD BOLT

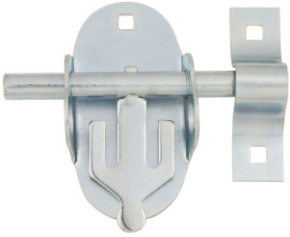

TECHNICAL DATA

ITEM CODE	SIZE	SHOOT LENGTH	LENGTH	WIDTH	THICKNESS	SCREW NO.	SHOOT DIA	WT/ PCS	PCS. IN INNER	PCS. IN OUTER	PCS. IN PALLET
MIRN004A100	4"	115	102	54	2.0	M6	12	0.280	10	80	1920

FINISH AVAILABLE - EXB, TEXTURE BLK, EXW, ZP, DUROSIL, EVERBLACK, HSG

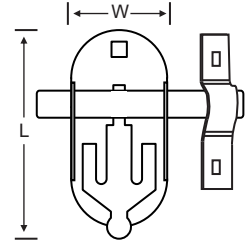

4ASA : MILD STEEL OVAL PADBOLT

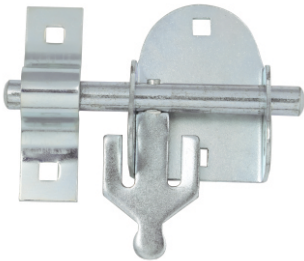

TECHNICAL DATA

ITEM CODE	SIZE	SHOOT LENGTH	LENGTH	WIDTH	THICKNESS	SHOOT DIA	BOLT	WT/ PCS	PCS. IN INNER	PCS. IN OUTER	PCS. IN PALLET
MIRN4ASA100	4"	115	75	55	2.0	12	M6	0.243	10	80	1920

FINISH AVAILABLE - EXB, TEXTURE BLK, EXW, ZP, DUROSIL, EVERBLACK, HSG

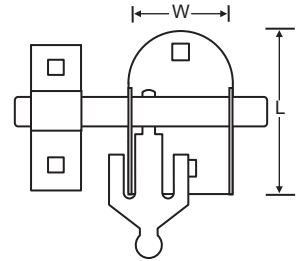

5A: MILD STEEL DOOR BOLT FOR PADLOCK



TECHNICAL DATA

ITEM CODE	SIZE	SHOOT LENGTH	LENGTH	WIDTH	THICKNESS	SCREW NO.	WT/ PCS	PCS. IN INNER	PCS. IN OUTER	PCS. IN PALLET
MIRN005A100	4"	94	101	43	2.2	6	0.130	10	120	5400
MIRN005A120	5"	107	121	45	2.1	6	0.160	10	100	3600
MIRN005A160	6"	144	160	53	2.2	6	0.310	5	60	2040

FINISH AVAILABLE - EXB, TEXTURE BLK, EXW, ZP, DUROSIL, EVERBLACK, HSG

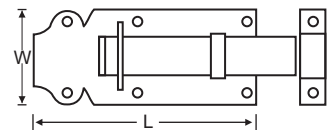

6A: MILD STEEL SLIMLINE PADBOLT

TECHNICAL DATA

ITEM CODE	SIZE	SHOOT LENGTH	LENGTH	WIDTH	THICKNESS	SCREW NO.	WT/ PCS	PCS. IN INNER	PCS. IN OUTER	PCS. IN PALLET
MIRN006A100	4"	112	68	32	2.0	6	0.112	10	120	5400
MIRN006A150	6"	144	95	46	2.0	8	0.282	5	60	2040

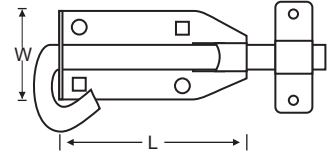

FINISH AVAILABLE - EXB, TEXTURE BLK, EXW, ZP, DUROSIL, EVERBLACK, HSG

1257 : MILD STEEL SLIDING ACTION BOLT (DOUBLE LOCKING)

TECHNICAL DATA

ITEM CODE	SIZE	SHOOT LENGTH	LENGTH	WIDTH	THICKNESS	BOLT	SHOOT DIA	WT/ PCS	PCS. IN INNER	PCS. IN OUTER	PCS. IN PALLET
MIRN1257100	4"	186	104	72	2.0	M6	9.0	0.283	10	80	2400

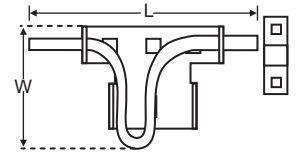

FINISH AVAILABLE - EXB, TEXTURE BLK, EXW, ZP, DUROSIL, EVERBLACK, HSG

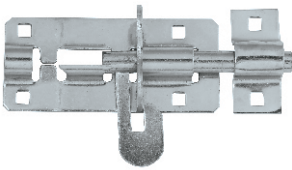
2ASA : MILD STEEL MEDIUM PADBOLT

TECHNICAL DATA

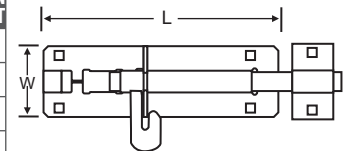
ITEM CODE	SIZE	SHOOT LENGTH	LENGTH	WIDTH	THICKNESS	BOLT	SHOOT DIA	WT/ PCS	PCS. IN INNER	PCS. IN OUTER	PCS. IN PALLET
MIRN2ASA100	4"	105	114	52	1.6	M6	12	0.230	5	40	1920
MIRN2ASA150	6"	156	170	52	1.6	M6	12	0.317	5	35	1575
MIRN2ASA200	8"	203	214	52	1.6	M6	12	0.404	5	25	1125
MIRN2ASA250	10"	255	265	52	1.6	M6	12	0.491	5	20	900
MIRN2ASA300	12"	300	315	52	1.6	M6	12	0.571	5	20	720



FINISH AVAILABLE - EXB, TEXTURE BLK, EXW, ZP, DUROSIL, EVERBLACK, HSG

SPARES : MILD STEEL KEEPS FOR PADBOLT

TECHNICAL DATA

ITEM CODE	LENGTH	WIDTH	THICKNESS	BOLT	WT/PCS	PCS. IN INNER	PCS. IN OUTER
1A	58	38	1.9	M6	0.057	50	800
2A	50	35	1.1	M6	0.017	50	800
2ASA	58	26	1.6	M6	0.024	50	500
4A, 4ASA	83	23	2.2	M6	0.044	25	400
6A	63	21	1.9	M6	0.024	50	500
1AAK	91	40	2.5	M6	0.098	20	200
2AAK	80	20	2.0	M6	0.035	20	200

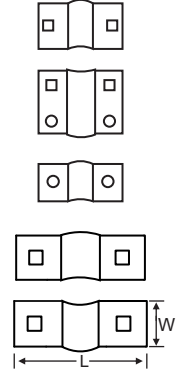

FINISH AVAILABLE - EXB, TEXTURE BLK, EXW, ZP, DUROSIL, EVERBLACK, HSG

60BHB : MILD STEEL BOW HANDLE BOLT

TECHNICAL DATA

ITEM CODE	SIZE	LENGTH	WIDTH	THICKNESS	SHOOT SQUARE	SCREW NO.	WT/PCS	PCS. IN INNER	PCS. IN OUTER	PCS. IN PALLET
MIRN60BH300	12"	305	50	2.0	16	10	0.864	2	20	560
MIRN60BH375	15"	380	50	2.0	16	10	0.927	2	20	480
MIRN60BH450	18"	458	50	2.0	16	10	1.081	2	16	192
MIRN60BH600	24"	610	50	2.0	16	10	1.215	2	12	168
MIRN60BH750	30"	762	50	2.0	16	10	1.349	2	12	240
MIRN60BH900	36"	915	50	2.0	16	10	1.483	2	12	240

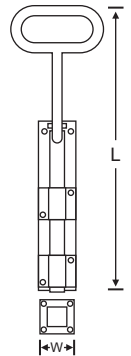

FINISH AVAILABLE - EXB, TEXTURE BLK, EXW, ZP, DUROSIL, EVERBLACK, HSG

60MTB : MILD STEEL MONKEY TAIL BOLT

TECHNICAL DATA

ITEM CODE	SIZE	LENGTH	WIDTH	THICKNESS	SHOOT SQUARE	SCREW NO.	WT/PCS	PCS. IN INNER	PCS. IN OUTER	PCS. IN PALLET
MIRN60MT300	12"	320	50	2.0	16	10	0.782	2	24	672
MIRN60MT375	15"	385	50	2.0	16	10	0.835	2	22	440
MIRN60MT450	18"	458	50	2.0	16	10	0.977	2	20	400
MIRN60MT600	24"	605	50	2.0	16	10	1.111	2	12	240
MIRN60MT750	30"	765	50	2.0	16	10	1.242	2	12	240
MIRN60MT900	36"	916	50	2.0	16	10	1.369	2	10	200

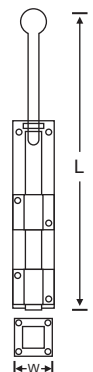

FINISH AVAILABLE - EXB, TEXTURE BLK, EXW, ZP, DUROSIL, EVERBLACK, HSG

66 : MILD STEEL CHAIN BOLT REVERSIBLE SPRING LOADED SHOOT



TECHNICAL DATA

ITEM CODE	SIZE	SHOOT LENGTH	LENGTH	WIDTH	SHOOT SQUARE	CHAIN LENGTH	SCREW NO.	WT/ PCS	PCS. IN INNER	PCS. IN OUTER	PCS. IN PALLET
MSCF0066210	8"	206	189	50	16	18"	10	0.585	5	30	1350

FINISH AVAILABLE - EXB, TEXTURE BLK, EXW, ZP, DUROSIL, EVERBLACK, HSG

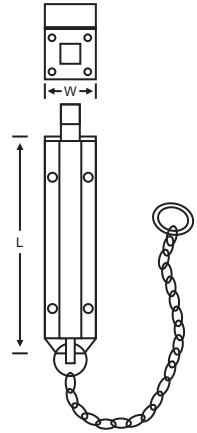

68 : MILD STEEL FOOTBOLT



TECHNICAL DATA

ITEM CODE	SIZE	LENGTH	WIDTH	SHOOT SQUARE	SHOOT LENGTH	THICKNESS	SCREW NO.	WT/ PCS	PCS. IN INNER	PCS. IN OUTER	PCS. IN PALLET
MIRN0068175	8"	186	50	16	205	2.0	10	0.850	5	25	1050

FINISH AVAILABLE - EXB, TEXTURE BLK, EXW, ZP, DUROSIL, EVERBLACK, HSG

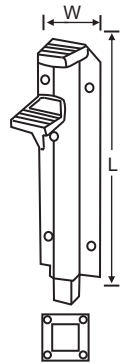

482-83-84-85 : MILD STEEL ACCESSORIES FOR BOLTS (TO SUIT 16MM BOLTS)

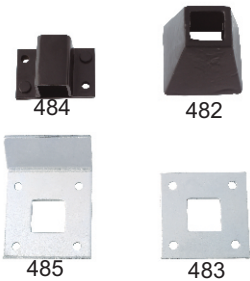

TECHNICAL DATA

ITEM CODE	LENGTH	WIDTH	THICKNESS	SCREW NO.	WT/ PCS	PCS. IN INNER	PCS. IN OUTER	PCS. IN PALLET
MIRN0482016	45	48	5.5	8	0.207	50	100	3000
MIRN0483016	50	50	2.0	8	0.033	50	500	20000
MIRN0484016	64	37	1.2	8	0.029	50	500	20000
MIRN0485016	70	50	3.0	8	0.072	50	250	10000

FINISH AVAILABLE - EXB, TEXTURE BLK, EXW, ZP, DUROSIL, EVERBLACK, HSG

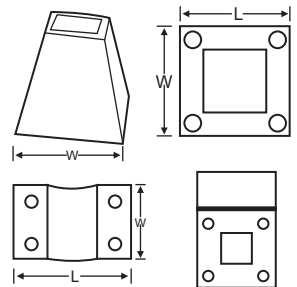

1259 : MILD STEEL DOOR BOLT

TECHNICAL DATA

ITEM CODE	SIZE	LENGTH	WIDTH	THICKNESS	SHOOT LENGTH	SHOOT DIA	SCREW NO.	WT/ PCS	PCS. IN INNER	PCS. IN OUTER	PCS. IN PALLET
MIRN1259150	6"	158	25	2.0	130	8.0	7	0.170	10	100	3600
MIRN1259200	8"	200	32	2.0	180	12.5	7	0.418	10	30	1800
MIRN1259250	10"	252	32	2.0	225	12.5	7	0.470	10	40	1440
MIRN1259300	12"	305	32	2.0	275	12.5	7	0.586	10	30	1260

FINISH AVAILABLE - EXB, TEXTURE BLK, EXW, ZP, DUROSIL, EVERBLACK, HSG

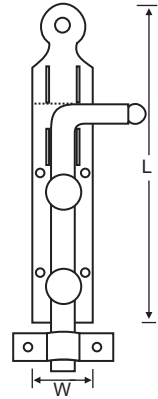
1260L : MILD STEEL LIGHT GARAGE DOOR BOLT WITH RECEIVER PLATE

TECHNICAL DATA

ITEM CODE	SIZE	LENGTH	SCREW NO.	THICKNESS	BOLT DIA	WT/ PCS	PCS. IN INNER	PCS. IN OUTER	PCS. IN PALLET
MIRN1260300	12"	310	8	3.0	16	1.003	2	20	600
MIRN1260375	15"	390	8	3.0	16	1.126	2	20	480
MIRN1260450	18"	465	8	3.0	16	1.250	2	16	480
MIRN1260600	24"	617	8	3.0	16	1.580	2	16	320
MIRN1260750	30"	770	10	3.0	16	1.825	2	12	288
MIRN1260900	36"	922	10	3.0	16	2.065	2	8	160

FINISH AVAILABLE - EXB, TEXTURE BLK, EXW, ZP, DUROSIL, EVERBLACK, HSG

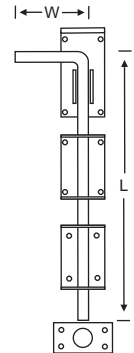
1260H : MILD STEEL HEAVY GARAGE DOOR BOLT WITH RECEIVER PLATE

TECHNICAL DATA

ITEM CODE	SIZE	LENGTH	SCREW NO.	THICKNESS	BOLT DIA	WT/ PCS	PCS. IN INNER	PCS. IN OUTER	PCS. IN PALLET
MIRN1160300	12"	310	8	4.0	16	1.602	2	20	600
MIRN1160450	18"	465	8	4.0	16	1.847	2	16	384
MIRN1160600	24"	617	8	4.0	16	2.085	2	12	240

FINISH AVAILABLE - EXB, TEXTURE BLK, EXW, ZP, DUROSIL, EVERBLACK, HSG

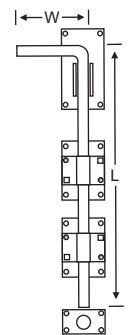

1260HLK : MILD STEEL LOCKING GARAGE DOOR BOLT

TECHNICAL DATA

ITEM CODE	SIZE	LENGTH	WIDTH	THICKNESS	SCREW NO.	WT/PCS	PCS. IN INNER	PCS. IN OUTER	PCS. IN PALLET
MIRN9971450	18"	455	140	4.0	8&12	1.940	2	4	288

FINISH AVAILABLE - EXB, TEXTURE BLK, EXW, ZP, DUROSIL, EVERBLACK, HSG

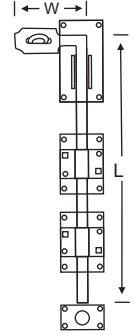
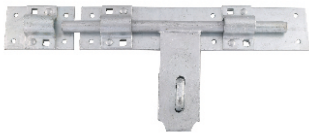
597 : MILD STEEL CROSS DOOR BOLT

TECHNICAL DATA

ITEM CODE	SIZE	LENGTH	WIDTH	SECTION THICKNESS	SCREW NO.	SHOOT DIA	WT/PCS	PCS. IN INNER	PCS. IN OUTER	PCS. IN PALLET
MIRN0597300	12"	316	64	4.0	8	16	1.936	2	8	400
MIRN0597450	18"	465	64	4.0	8	16	2.640	2	8	340
MIRN0597600	24"	616	64	4.0	8	16	3.000	2	8	160

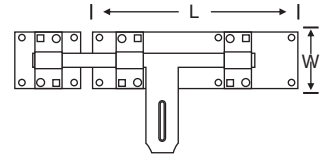
FINISH AVAILABLE - EXB, TEXTURE BLK, EXW, ZP, DUROSIL, EVERBLACK, HSG

213 : MILD STEEL CANE BOLT

TECHNICAL DATA

ITEM CODE	SIZE	LENGTH	WIDTH	SHOOT DIA	SCREW NO.	WT/PCS	PCS. IN INNER	PCS. IN OUTER
MGFI0213300	12"	306	75	12.0	10	0.494	2	2

FINISH AVAILABLE - EXB, TEXTURE BLK, EXW, ZP, DUROSIL, EVERBLACK, HSG

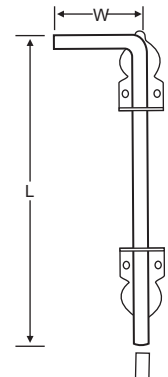

7A : MILD STEEL AUTO LOCK PIG BOLT

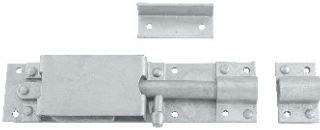

TECHNICAL DATA

ITEM CODE	SIZE	LENGTH	WIDTH	THICKNESS	SHOOT DIA	WT/PCS	SCREW NO.	PCS. IN INNER	PCS. IN OUTER
MGFI007A200	8"	215	50	2.1	14.0	0.668	8	5	20

FINISH AVAILABLE - EXB, TEXTURE BLK, EXW, ZP, DUROSIL, EVERBLACK, HSG

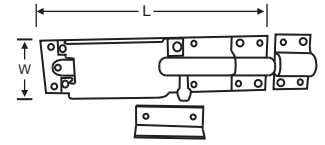

1836 : MILD STEEL SPRING LOADED ANIMAL BOLT



TECHNICAL DATA

ITEM CODE	SIZE	LENGTH	WIDTH	SECTION THICKNESS	SCREW NO.	SHOOT DIA	WT/PCS	PCS.IN INNER	PCS. IN OUTER	PCS.IN PALLET
MGFI1836010	3/8"	143	40	3.0	10	10	0.330	5	50	2500
MGFI1836012	1/2"	225	40	4.0	10	12	0.572	5	30	1200
MGFI1836016	5/8"	242	50	5.0	10	16	1.042	5	15	720

FINISH AVAILABLE - EXB, TEXTURE BLK, EXW, ZP, DUROSIL, EVERBLACK, HSG

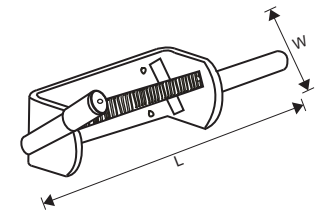

1835 : MILD STEEL SPRING LOADED ANIMAL BOLT C/W STAPLE



TECHNICAL DATA

ITEM CODE	SIZE	LENGTH	WIDTH	THICKNESS	SCREW NO.	SHOOT DIA	WT/PCS	PCS.IN INNER	PCS. IN OUTER	PCS. IN PALLET
MGFI1835010	3/8"	143	40	3.0	10	10	0.486	5	40	1600
MGFI1835012	1/2"	225	40	4.0	10	12	0.728	5	30	720
MGFI1835016	5/8"	242	50	5.0	10	16	1.239	5	15	540

FINISH AVAILABLE - EXB, TEXTURE BLK, EXW, ZP, DUROSIL, EVERBLACK, HSG

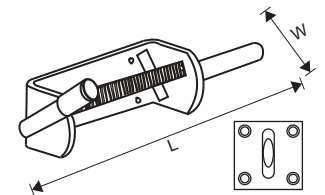

BRASS FLUSH BOLT



TECHNICAL DATA

DPG CODE	ITEM CODE	LENGTH	WIDTH	SCREW NO.	WT/PCS	PCS. IN INNER	PCS. IN OUTER
GB3100	BMIH3100150	153	19	6	0.145	10	100
GB3101	BMIH3101200	205	19	6	0.178	10	100

FINISH AVAILABLE - POLISHED & LACQUERED BRASS/CP/SNP

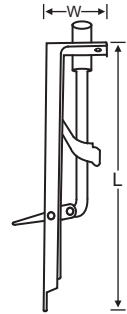

ALUMINIUM FLUSH BOLT



TECHNICAL DATA

DPG CODE	ITEM CODE	LENGTH	WIDTH	SCREW NO.	WT/PCS	PCS. IN INNER	PCS. IN OUTER
GA1671	AMIH1671150	150	19	6	0.065	10	100
GA1672	AMIH1672200	201	19	6	0.085	10	100

Finish Available : SAA,

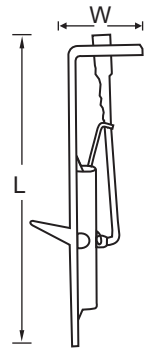

1819 : MILD STEEL AUTOMATIC GATE CATCH STEEL CASE & PEG



TECHNICAL DATA

ITEM CODE	SIZE	LENGTH	WIDTH	THICK.	SCREW NO.	PEG DIA LENGTH	WT/ SET	SET. IN INNER	SET. IN OUTER	SET. IN PALLET
MGFI1819050	2"	51	45	1.4	6	8.5x112	0.148	10	140	3780

FINISH AVAILABLE - EXB, TEXTURE BLK, EXW, ZP, DUROSIL, EVERBLACK, HSG

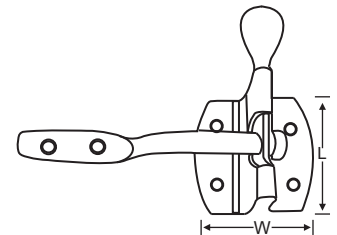

1819AH : MILD STEEL AUTOMATIC GATE CATCH STEEL CASE & PEG (SA PATTERN)

TECHNICAL DATA

ITEM CODE	SIZE	LENGTH	WIDTH	THICK.	SCREW NO.	PEG DIA LENGTH	WT/ SET	SET. IN INNER	SET. IN OUTER	SET. IN PALLET
MGF1818050	1.5"	40	40	1.9	6	9.5X115	0.140	10	140	3780

FINISH AVAILABLE - EXB, TEXTURE BLK, EXW, ZP, DUROSIL, EVERBLACK, HSG

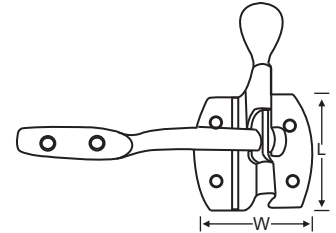
1819B : MILD STEEL AUTOMATIC GATE CATCH STEEL CASE & PEG

TECHNICAL DATA

ITEM CODE	SIZE	LENGTH	WIDTH	THICK.	SCREW NO.	PEG DIA LENGTH	WT/ SET	SET. IN INNER	SET. IN OUTER	SET. IN PALLET
MGF1719050	2"	45	41	2.7	6	8.5X115	0.170	10	140	3780

FINISH AVAILABLE - EXB, TEXTURE BLK, EXW, ZP, DUROSIL, EVERBLACK, HSG

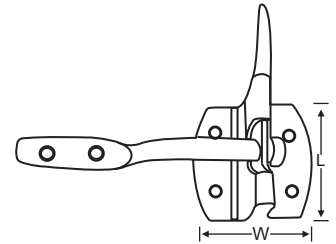
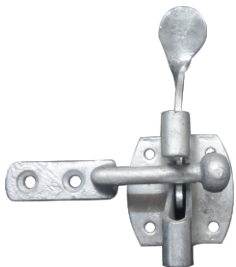
1822 : MILD STEEL HEAVY AUTOMATIC GATE CATCH STEEL CASE, MALLEABLE IRON PEG

TECHNICAL DATA

ITEM CODE	SIZE	LENGTH	WIDTH	THICK.	SCREW NO.	PEG DIA LENGTH	WT/ SET	SET. IN INNER	SET. IN OUTER	SET. IN PALLET
MGF1822050	2"	57	56	2.6	6	8x114	0.313	10	60	1800

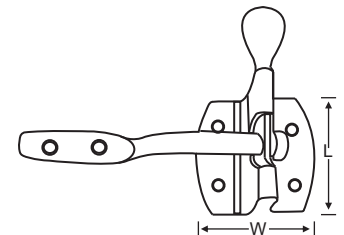
FINISH AVAILABLE - EXB, TEXTURE BLK, EXW, ZP, DUROSIL, EVERBLACK, HSG



PEGS FOR AUTOMATIC GATE CATCHES



TECHNICAL DATA

ITEM CODE	LENGTH	WIDTH	SCREW NO.	PEG DIA	WT/PCS	PCS. IN INNER	PCS. IN OUTER
1819	114	15	8	9	0.053	20	200
1822	116	22	12	9	0.115	20	100

FINISH AVAILABLE - EXB, TEXTURE BLK, EXW, ZP, DUROSIL, EVERBLACK, HSG

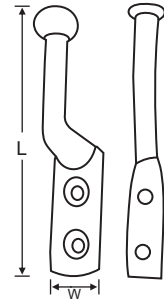

20 : MILD STEEL SUFFOLK LATCH



TECHNICAL DATA

DPG CODE	ITEM CODE	SIZE	LENGTH	WIDTH	THICKNESS	SCREW NO.	WT/ SET	SET. IN INNER	SET. IN OUTER	SET. IN PALLET
20	MIRN0020175	7"	179	45	1.5	6	0.380	5	50	800
20	MIRN0020190	7.5"	191	45	1.5	6	0.400	5	50	800
20	MIRN0020200	8"	205	45	1.5	6	0.400	5	50	800
20	MIRN0050230	9"	230	45	1.5	6	0.415	5	50	800

FINISH AVAILABLE - EXB, TEXTURE BLK, EXW, ZP, DUROSIL, EVERBLACK, HSG

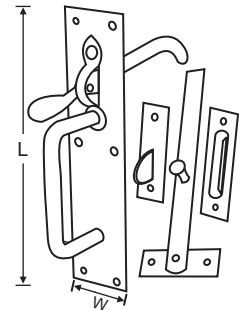

50/4: MILD STEEL SUFFOLK LATCH HEAVY



TECHNICAL DATA

DPG CODE	ITEM CODE	SIZE	LENGTH	WIDTH	THICKNESS	SCREW NO.	WT/ SET	SET. IN INNER	SET. IN OUTER	SET. IN PALLET
50/4	MIRN0020175	7"	179	45	2.0	6	0.412	5	50	800
50/4	MIRN0020190	7.5"	191	45	2.0	6	0.418	5	50	800
50/4	MIRN0020200	8"	205	45	2.0	6	0.436	5	50	800
50/4	MIRN0050230	9"	230	45	2.0	6	0.483	5	50	800

FINISH AVAILABLE - EXB, TEXTURE BLK, EXW, ZP, DUROSIL, EVERBLACK, HSG

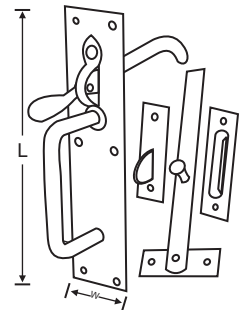

20P MILD STEEL SUFFOLK LATCH PREMIUM RANGE



TECHNICAL DATA

DPG CODE	ITEM CODE	SIZE	LENGTH	WIDTH	THICKNESS	SCREW NO.	WT/SET	SET. IN INNER	SET. IN OUTER	SET. IN PALLET
20P	MIRN020P230	9"	220	50	2.2	8	0.645	5	50	800

FINISH AVAILABLE - EXB, TEXTURE BLK, EXW, ZP, DUROSIL, EVERBLACK, HSG

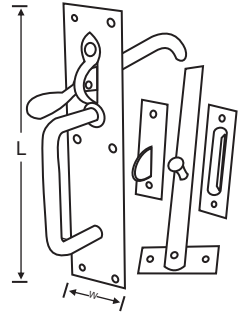

SPARES: MILD STEEL FOR 20/2 SUFFOLK LATCH (KEEP, CATCH & T BAR)

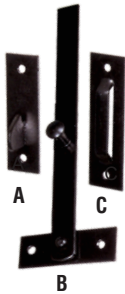

TECHNICAL DATA

ITEM CODE	LENGTH	WIDTH	THICKNESS	SCREW NO.	WT/PCS	PCS. IN INNER	PCS. IN OUTER
MMIH020CXXX(A)	74	22	1.5	6	0.025	50	500
MMIH020LXXX(B)	192	65	1.5	6	0.087	20	200
MMIH020KXXX(C)	87	25	1.5	6	0.025	50	500

FINISH AVAILABLE - EXB, TEXTURE BLK, EXW, ZP, DUROSIL, EVERBLACK, HSG

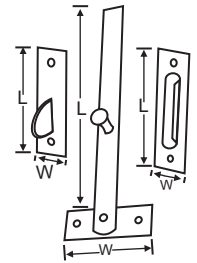

BLACK ANTIQUE THUMB LATCH SET



TECHNICAL DATA

DPG CODE	ITEM CODE	LENGTH	WIDTH	SCREW NO.	WT/SET	SET. IN INNER	SET. IN OUTER	SET. IN PALLET
G0350	CMIH0350200	140	192	8	0.590	5	30	1200
G0801	CIRN0801200	155	197	7	0.620	5	30	1200

FINISH AVAILABLE : EXB, DUROSIL

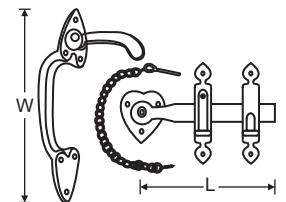

1136 : MILD STEEL GATE LATCH PLAIN RING HANDLE

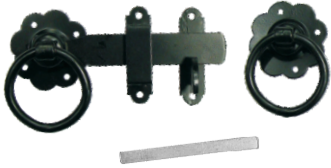

TECHNICAL DATA

ITEM CODE	SIZE	LENGTH	WIDTH	THICKNESS	SCREW NO.	WT/ SET	SET. IN INNER	SET. IN OUTER	SET. IN PALLET
MIRN1136127	5"	127	25	4.0	6	0.522	5	40	1440
MIRN1136150	6"	152	25	4.0	6	0.540	5	30	1170
MIRN1136178	7"	178	25	4.0	6	0.562	5	30	1170

FINISH AVAILABLE - EXB, TEXTURE BLK, EXW, ZP, DUROSIL, EVERBLACK, HSG
RING DIA (70MM X 8MM), SPINDLE 8MM X 90MM

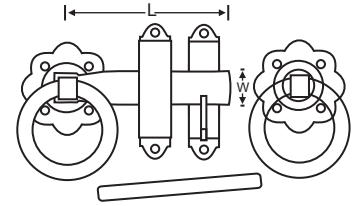

1136BR : MILD STEEL GATE LATCH PLAIN BIG RING HANDLE



TECHNICAL DATA

ITEM CODE	SIZE	LENGTH	WIDTH	THICKNESS	SCREW NO.	WT/ PCS	PCS. IN INNER	PCS. IN OUTER	PCS. IN PALLET
MIRN1137127	5"	127	25	4.0	6	0.565	5	35	1260
MIRN1137150	6"	152	25	4.0	6	0.567	5	30	1170
MIRN1137178	7"	178	25	4.0	6	0.569	5	30	1170

FINISH AVAILABLE - EXB, TEXTURE BLK, EXW, ZP, DUROSIL, EVERBLACK, HSG
Note : Also Available 1136BR Premium
RING DIA (85MM X 8MM) SPINDLE 8MM X 90MM

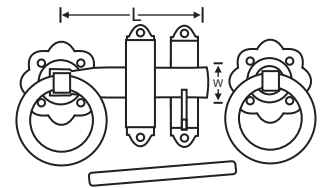

1136EH : MILD STEEL EXTRA HEAVY GATE LATCH PLAIN RING HANDLE

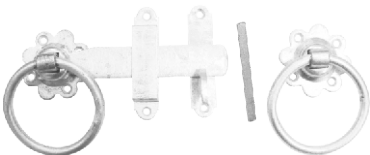

TECHNICAL DATA

ITEM CODE	SIZE	LENGTH	WIDTH	THICKNESS	SCREW NO.	WT/ PCS	PCS. IN INNER	PCS. IN OUTER	PCS. IN PALLET
MIRN1138127	5"	127	25	4.0	6	0.639	5	35	1260
MIRN1138150	6"	152	25	4.0	6	0.642	5	30	1170
MIRN1138178	7"	178	25	4.0	6	0.645	5	30	1170

FINISH AVAILABLE - EXB, TEXTURE BLK, EXW, ZP, DUROSIL, EVERBLACK, HSG
RING DIA (70MM X 8MM) SPINDLE 8MM X 90MM

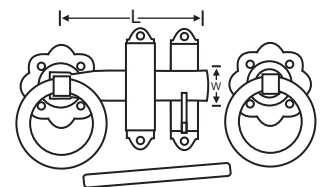

1141 : MILD STEEL GATE LATCH TWISTED RING HANDLE

TECHNICAL DATA

ITEM CODE	SIZE	LENGTH	WIDTH	THICKNESS	SCREW NO.	WT/ SET	SET. IN INNER	SET. IN OUTER	SET. IN PALLET
MIRN1141127	5"	127	25	4.0	6	0.522	5	40	1440
MIRN1141150	6"	152	25	4.0	6	0.540	5	30	1170
MIRN1141178	7"	178	25	4.0	6	0.562	5	30	1170

FINISH AVAILABLE - EXB, TEXTURE BLK, EXW, ZP, DUROSIL, EVERBLACK, HSG

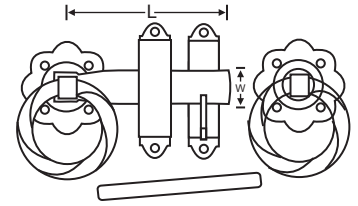
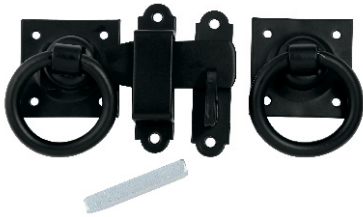
1136A : MILD STEEL WENDY HOUSE LATCH

TECHNICAL DATA

ITEM CODE	SIZE	LENGTH	WIDTH	THICKNESS	SCREW NO.	WT/ SET	SET. IN INNER	SET. IN OUTER	SET. IN PALLET
MIRN1135100	4"	101	25	3.2	6	0.411	5	40	1280

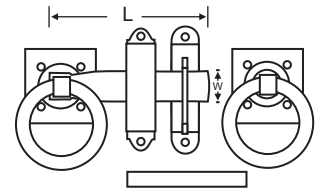
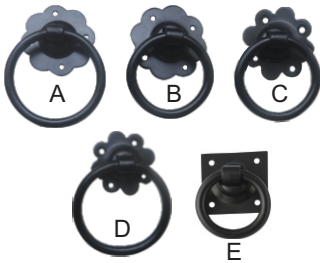
FINISH AVAILABLE - EXB, TEXTURE BLK, EXW, ZP, DUROSIL, EVERBLACK, HSG

SPARES : MILD STEEL RING ONLY

TECHNICAL DATA

ITEM CODE	ROSE DIA	RING DIA	RING WIRE DIA	SCREW NO.	WT/PCS	PCS. IN INNER	PCS. IN OUTER	PCS. IN PALLET
MIRN0137065(A)	66	85	8.0	6	0.170	10	100	3600
MIRN0136065(B)	66	70	8.0	6	0.145	10	100	3600
MIRN0138060(C)	60	70	8.0	6	0.145	10	100	3600
MIRN0139060(D)	60	85	8.0	6	0.171	10	100	3600
MIRN0140050(E)	52	58	8.0	6	0.121	10	100	3600

FINISH AVAILABLE - EXB, TEXTURE BLK, EXW, ZP, DUROSIL, EVERBLACK, HSG

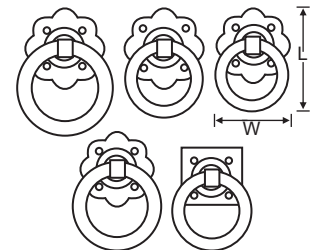
Note : Also available 141 (Twisted) Ring Handle.



BLACK ANTIQUE RING GATE LATCH TWISTED (HEAVY SQUARE PATTERN)

TECHNICAL DATA

DPG CODE	ITEM CODE	LENGTH	WIDTH	SCREW NO.	WT/SET	SET. IN INNER	SET. IN OUTER
G2255	CIRN2255180	180	64X64	7	0.965	5	20

FINISH AVAILABLE : EXB, EXW, DUROSIL

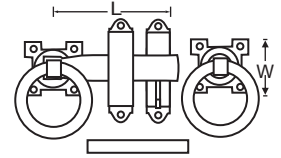
SPARES : MILD STEEL FOR RING GATE LATCH (KEEP & CATCH)



R1

R2

TECHNICAL DATA

ITEM CODE	LENGTH	WIDTH	THICKNESS	SCREW NO.	WT/PCS	PCS. IN INNER	PCS. IN OUTER	PCS. IN PALLET
MIRN136KXXX(R1)	80	20	1.7	8	0.042	50	400	14400
MIRN136CXXX(R2)	79	20	2.0	8	0.045	50	400	14400

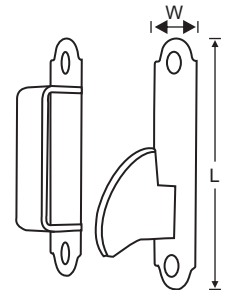
FINISH AVAILABLE - EXB, TEXTURE BLK, EXW, ZP, DUROSIL, EVERBLACK, HSG

1131 : MILD STEEL SURFACE LATCH

TECHNICAL DATA

ITEM CODE	SIZE	WIDTH	SCREW NO.	WT/PCS	PCS. IN INNER	PCS. IN OUTER
MIRN1131175	7"	56	8	0.265	10	60

FINISH AVAILABLE - EXB, TEXTURE BLK, EXW, ZP, DUROSIL, EVERBLACK, HSG

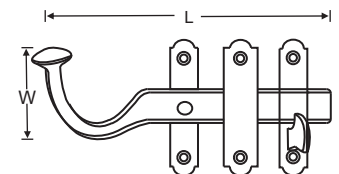

1261SS : STAINLESS STEEL CABIN HOOK
TECHNICAL DATA

ITEM CODE	LENGTH	ROAD DIA	THICKNESS	SCREW NO.	WT/PCS	PCS. IN INNER	PCS. IN OUTER	PCS. IN PALLET
SIRN1261065	65	3.8	1.7	6	0.023	20	400	11200
SIRN1261075	75	3.8	1.7	6	0.025	20	400	11200
SIRN1261100	100	5.6	1.7	6	0.043	20	400	11200
SIRN1261125	125	5.6	1.7	6	0.047	20	300	10800
SIRN1261150	150	5.6	1.7	6	0.052	20	300	10800
SIRN1261200	200	5.6	1.7	6	0.061	20	300	9000

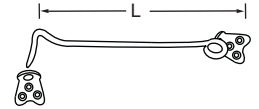

FINISH AVAILABLE - SATIN, MIRROR

1261 : MILD STEEL WIRE CABIN HOOK
TECHNICAL DATA

ITEM CODE	SIZE	LENGTH	WIDTH	WIRE DIA	THICKNESS	SCREW NO.	WT/PCS	PCS. IN INNER	PCS. IN OUTER	PCS. IN PALLET
MIRN1261075	3"	76	40	6.25	2.0	6	0.095	20	240	7200
MIRN1261100	4"	101	40	6.25	2.0	6	0.104	20	200	6000
MIRN1261150	6"	152	40	6.25	2.0	6	0.115	10	200	6000
MIRN1261200	8"	200	40	7.5	2.0	6	0.169	10	120	4320
MIRN1261250	10"	250	40	7.5	2.0	6	0.193	10	100	3600
MIRN1261300	12"	300	40	7.5	2.0	6	0.219	10	100	2400

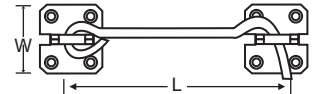

FINISH AVAILABLE - EXB, TEXTURE BLK, EXW, ZP, DUROSIL, EVERBLACK, HSG

1262 : MILD STEEL EXTRA LONG CABIN HOOK
TECHNICAL DATA

ITEM CODE	SIZE	LENGTH	WIDTH	WIRE DIA	THICKNESS	SCREW NO.	WT/PCS	PCS. IN INNER	PCS. IN OUTER	PCS. IN PALLET
MIRN1262150	6"	160	42	5.8	1.8	6	0.052	20	300	7200
MIRN1262200	8"	210	42	5.8	1.8	6	0.063	20	240	7200
MIRN1262250	10"	260	42	5.6	1.8	6	0.075	20	300	7200
MIRN1262300	12"	310	42	5.6	1.8	6	0.088	20	240	5760
MIRN1262350	14"	350	42	5.6	1.8	6	0.095	20	200	4800
MIRN1262375	15"	375	42	5.6	1.8	6	0.100	20	160	3840
MIRN1262450	18"	460	42	5.6	1.8	6	0.132	20	140	3360

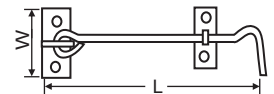

FINISH AVAILABLE - EXB, TEXTURE BLK, EXW, ZP, DUROSIL, EVERBLACK, HSG

BRASS VICTORIAN CABIN HOOK



TECHNICAL DATA

DPG CODE	ITEM CODE	LENGTH	WIDTH	SCREW NO.	WT/ PCS	PCS. IN INNER	PCS. IN OUTER	PCS. IN PALLET
GB2601	BMIH2601075	98	35	6	0.080	10	200	4500
GB2602	BMIH2602100	115	35	6	0.088	10	200	4500
GB2603	BMIH2603150	160	35	6	0.100	10	160	4800
GB2604	BMIH2604203	215	35	6	0.140	10	140	4200

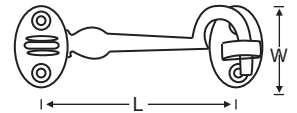

FINISH AVAILABLE - POLISHED & LACQUERED BRASS/CP/SNP

BRASS VICTORIAN HEAVY CABIN HOOK



TECHNICAL DATA

DPG CODE	ITEM CODE	LENGTH	WIDTH	SCREW NO.	WT/ PCS	PCS. IN INNER	PCS. IN OUTER	PCS. IN PALLET
GB2612	BMIH2612150	175	39	6	0.163	10	100	3600
GB2613	BMIH2613200	220	39	6	0.189	10	100	3600
GB2614	BMIH2614250	265	42	6	0.260	5	60	2040
GB2615	BMIH2615300	320	42	6	0.325	5	40	1560



FINISH AVAILABLE - POLISHED & LACQUERED BRASS/CP/SNP

BLACK ANTIQUE CABIN HOOK SQUARE CAST PLATE



TECHNICAL DATA

DPG CODE	ITEM CODE	LENGTH	WIDTH	SCREW NO.	WT/PCS	PCS. IN INNER	PCS. IN OUTER	PCS. IN PALLET
G0420	CMIH0420100	105	54	8	0.193	10	100	4500
G0421	CMIH0421150	155	54	8	0.202	10	80	3520

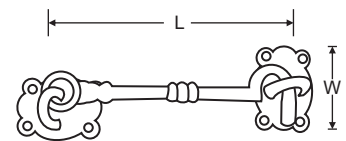

FINISH AVAILABLE : EXB, DUROSIL, HSG

BLACK ANTIQUE CABIN HOOK OVAL PLATE
TECHNICAL DATA

DPG CODE	ITEM CODE	LENGTH	WIDTH	SCREW NO.	WT/ PCS	PCS. IN INNER	PCS. IN OUTER	PCS. IN PALLET
G2099	CIRN2099075	76	45	8	0.102	20	100	5000
G2100	CIRN2100100	102	45	8	0.126	20	100	5000
G2101	CIRN2101150	152	45	8	0.140	10	120	4320
G2102	CIRN2102200	203	45	8	0.224	10	80	3200
G2103	CIRN2103250	255	45	8	0.236	10	80	3120
G2104	CIRN2104300	305	45	8	0.274	10	60	2100

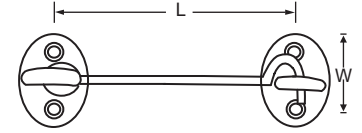

FINISH AVAILABLE : EXB, DUROSIL, HSG

BLACK ANTIQUE CABIN HOOK OVAL PLATE WITH RING
TECHNICAL DATA

DPG CODE	ITEM CODE	LENGTH	WIDTH	SCREW NO.	WT/ PCS	PCS. IN INNER	PCS. IN OUTER	PCS. IN PALLET
G2099A	CIRN3099075	85	45	8	0.104	20	100	5000
G2100A	CIRN3100100	105	45	8	0.120	20	100	5000
G2101A	CIRN3101150	155	45	8	0.142	10	120	4320
G2102A	CIRN3102200	210	45	8	0.205	10	80	3200
G2103A	CIRN3103250	255	45	8	0.226	10	80	3120
G2104A	CIRN3104300	310	45	8	0.330	10	60	2100

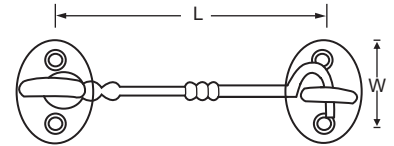

FINISH AVAILABLE : EXB, DUROSIL, HSG

149M : MILD STEEL SAFETY HASP AND STAPLE (MEDIUM WEIGHT LOCKING BAR)
TECHNICAL DATA

ITEM CODE	SIZE	LENGTH	WIDTH	THICKNESS	SCREW NO.	WT/ PCS	PCS. IN INNER	PCS. IN OUTER	PCS. IN PALLET
MIRN149M200	8"	201	45	3.6	12	0.396	5	40	1920
MIRN149M250	10"	250	54	4.0	12	0.614	5	35	1200

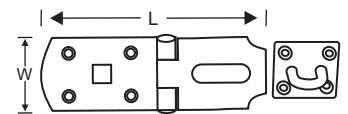

FINISH AVAILABLE - EXB, TEXTURE BLK, EXW, ZP, DUROSIL, EVERBLACK, HSG

147 : MILD STEEL SWIVEL LOCKING BAR

TECHNICAL DATA

ITEM CODE	SIZE	LENGTH	WIDTH	THICKNESS	SCREW NO.	WT/ PCS	PCS. IN INNER	PCS. IN OUTER	PCS. IN PALLET
MIRN0147200	8"	203	54	4.0	12	0.693	5	25	1000
MIRN0147250	10"	251	54	4.0	12	0.780	5	25	1000
MIRN0147300	12"	307	54	4.0	12	0.870	5	20	800

FINISH AVAILABLE - EXB, TEXTURE BLK, EXW, ZP, DUROSIL, EVERBLACK, HSG

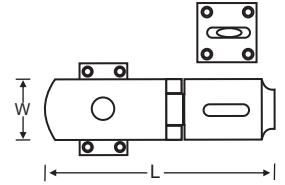
146 : MILD STEEL VERTICAL HASP AND STAPLE

TECHNICAL DATA

ITEM CODE	SIZE	LENGTH	WIDTH	THICKNESS	SCREW NO.	WT/ PCS	PCS. IN INNER	PCS. IN OUTER	PCS. IN PALLET
MIRN0146150	6"	150	54	4.6	12	0.651	5	25	1000

FINISH AVAILABLE - EXB, TEXTURE BLK, EXW, ZP, DUROSIL, EVERBLACK, HSG

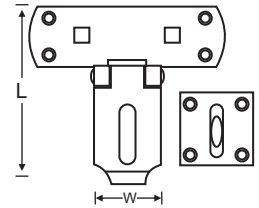
617 : MILD STEEL SAFETY HASP AND STAPLE

TECHNICAL DATA

ITEM CODE	SIZE	LENGTH	WIDTH	THICKNESS	SCREW NO.	WT/ PCS	PCS. IN INNER	PCS. IN OUTER	PCS. IN PALLET
MIRN0617075	3"	76	38	2.0	8	0.090	10	240	9600
MIRN0617090	3.5"	90	38	2.0	8	0.104	10	160	6400
MIRN0617100	4.5"	114	38	2.0	8	0.142	10	160	6400
MIRN0617150	6"	152	38	2.0	8	0.160	10	120	4800

FINISH AVAILABLE - EXB, TEXTURE BLK, EXW, ZP, DUROSIL, EVERBLACK, HSG

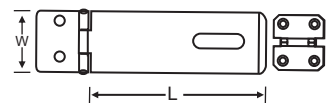

617EL : MILD STEEL SAFETY HASP AND STAPLE (EXTRA LIGHT PATTERN)



TECHNICAL DATA

ITEM CODE	SIZE	LENGTH	WIDTH	THICKNESS	SCREW NO.	WT/ PCS	PCS. IN INNER	PCS. IN OUTER	PCS. IN PALLET
MIRN0618100	4"	100	30	1.0	4	0.038	25	500	12000

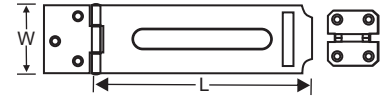

FINISH AVAILABLE - EXB, TEXTURE BLK, EXW, ZP, DUROSIL, EVERBLACK, HSG

149 : MILD STEEL SAFETY HASP AND STAPLE (HEAVY PATTERN)



TECHNICAL DATA

ITEM CODE	SIZE	LENGTH	WIDTH	THICKNESS	SCREW NO.	WT/ PCS	PCS. IN INNER	PCS. IN OUTER	PCS. IN PALLET
MIRN0149150	6"	158	54	4	12	0.457	5	40	1760
MIRN0149200	8"	203	54	4	12	0.550	5	40	1440
MIRN0149250	10"	253	54	4	12	0.635	5	35	1225
MIRN0149300	12"	305	54	4	12	0.725	5	30	900



FINISH AVAILABLE - EXB, TEXTURE BLK, EXW, ZP, DUROSIL, EVERBLACK, HSG

* Extra Heavy Pattern

GLH001: MILD STEEL LOCKING HASP AND STAPLE



TECHNICAL DATA

ITEM CODE	SIZE	LENGTH	WIDTH	THICKNESS	SCREW NO.	WT/ PCS	PCS. IN INNER	PCS. IN OUTER	PCS. IN PALLET
MSCF0001075	3"	78	32	1.5	5	0.110	10	100	2800
MSCF0001100	4"	115	32	1.5	5	0.120	10	100	2800

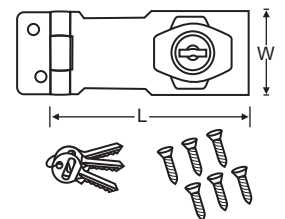

FINISH AVAILABLE - EXB, BZP, DUROSIL, EVERBLACK, CP

BRASS HASP & STAPLE



TECHNICAL DATA

DPG CODE	ITEM CODE	SIZE	LENGTH	WIDTH	THICKNESS	SCREW NO.	WT/PCS	PCS. IN INNER	PCS. IN OUTER
GB0617	BMIH0617050	2"	45	17	1.4	4	0.016	20	500
GB0617	BMIH0617063	2.5"	60	17	1.4	4	0.018	20	500
GB0617	BMIH0617075	3"	70	17	1.4	4	0.020	20	500
GB0617	BMIH0617100	4"	95	22	1.4	4	0.037	20	400

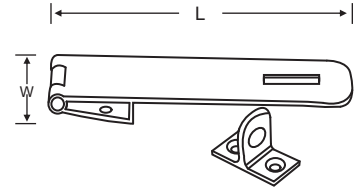

FINISH AVAILABLE - POLISHED & LACQUERED BRASS, CP, SNP

151LH / 151RH : MILD STEEL PADLOCK PROTECTION BAR (RIGHT HAND & LEFT HAND)



TECHNICAL DATA

DPG CODE	ITEM CODE	SIZE	LENGTH	WIDTH	THICK.	SCREW NO.	WT/PCS	PCS. IN INNER	PCS. IN OUTER	PCS. IN PALLET
151LH	MIRN151L185	7"	180	58	2.0	M6	0.690	2	30	1080
151RH	MIRN151R185	7"	180	58	2.0	M6	0.690	2	30	1080
152LH	MIRN152L185	7"	185	64	2.0	M6	1.000	2	20	720
152RH	MIRN152R185	7"	185	64	2.0	M6	1.000	2	20	720

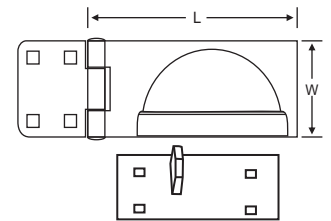

FINISH AVAILABLE - EXB, TEXTURE BLK, EXW, ZP, DUROSIL, EVERBLACK, HSG

149LW : MILD STEEL WIRE HASP AND STAPLE (LIGHT PATTERN)



TECHNICAL DATA

ITEM CODE	SIZE	LENGTH	WIDTH	THICKNESS	SCREW NO.	WT/PCS	PCS. IN INNER	PCS. IN OUTER	PCS. IN PALLET
MIRN0150075	3"	76	26	1.0	6	0.018	50	800	24000
MIRN0150100	4"	101	26	1.0	6	0.022	50	500	24000

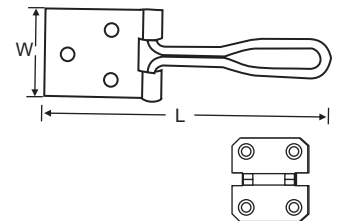

FINISH AVAILABLE - EXB, TEXTURE BLK, EXW, ZP, DUROSIL, EVERBLACK, HSG

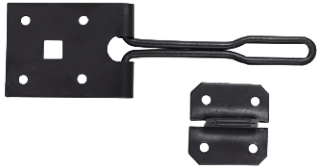
149W : MILD STEEL WIRE HASP AND STAPLE

TECHNICAL DATA

ITEM CODE	SIZE	LENGTH	WIDTH	THICKNESS	SCREW NO.	WT/ PCS	PCS. IN INNER	PCS. IN OUTER	PCS. IN PALLET
MIRN149W125	5"	125	45	2.0	7	0.080	10	200	5600
MIRN149W150	6"	150	45	2.0	7	0.088	10	200	5600

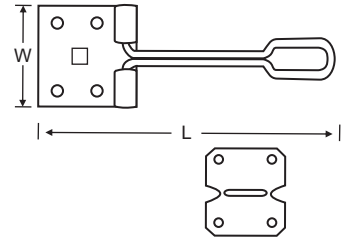
FINISH AVAILABLE - EXB, TEXTURE BLK, EXW, ZP, DUROSIL, EVERBLACK, HSG

1010 : MILD STEEL GARAGE DOOR HOLDER SENIOR FOR WIDE LINTELS

TECHNICAL DATA

ITEM CODE	SIZE	LENGTH	WIDTH	THICKNESS	SCREW NO.	WT/ PCS	PCS. IN INNER	PCS. IN OUTER	PCS. IN PALLET
MGFI1010600	24"	620	58	4.0	10	0.911	2	20	220

FINISH AVAILABLE - EXB, TEXTURE BLK, EXW, EX BLUE, ZP, DUROSIL, EVERBLACK, HSG

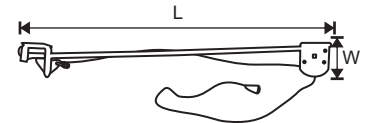
1011: MILD STEEL GARAGE DOOR HOLDER FOR NARROW LINTELS

TECHNICAL DATA

ITEM CODE	SIZE	LENGTH	WIDTH	THICKNESS	SCREW NO.	WT/ PCS	PCS. IN INNER	PCS. IN OUTER	PCS. IN PALLET
MGFI1011600	24"	620	58	4.0	10	1.00	2	20	220

FINISH AVAILABLE - EXB, TEXTURE BLK, EXW, ZP, DUROSIL, EVERBLACK, HSG

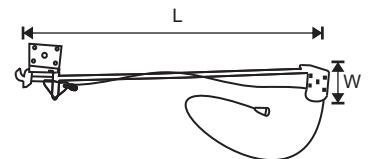

1012 : MILD STEEL GARAGE DOOR HOLDER JUNIOR FOR WIDE LINTELS



TECHNICAL DATA

ITEM CODE	SIZE	LENGTH	WIDTH	THICKNESS	SCREW NO.	WT/ PCS	PCS. IN INNER	PCS. IN OUTER	PCS. IN PALLET
MGF1012375	15"	380	58	4.0	10	0.730	2	20	320

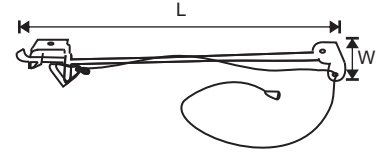

FINISH AVAILABLE - EXB, TEXTURE BLK, EXW, ZP, DUROSIL, EVERBLACK, HSG

SSB001: MILD STEEL SHED SECURITY BAR



TECHNICAL DATA

ITEM CODE	LENGTH	OVAL SIZE	WT/PCS	PCS. IN INNER	PCS. IN OUTER
MSCF1024I43	1080	38X20	1.806	1	10

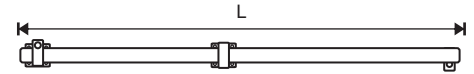

FINISH AVAILABLE - EXB, TEXTURE BLK, EXW, ZP, DUROSIL, EVERBLACK, HSG

236FB : MILD STEEL HANDRAIL BRACKET FIX BENDED (EURO) (FRENCH SPECIFICATION)



TECHNICAL DATA

ITEM CODE	SIZE	LENGTH	TOP PLATE LxW	ROD DIA	SCREW NO.	WT/ PCS	PCS. IN INNER	PCS. IN OUTER	PCS. IN PALLET
MIRN0237075	3"	75	70x18	10	10	0.148	10	100	2400

FINISH AVAILABLE - EXB, TEXTURE BLK, EXW, ZP, DUROSIL, EVERBLACK, HSG

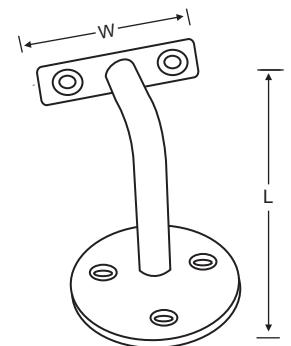

236AB/AS MILD STEEL HANDRAIL BRACKETS ADJUSTABLE BENDED/STRAIGHT (FRENCH SPECIFICATION)



TECHNICAL DATA

ITEM CODE	SIZE	LENGTH	WIDTH	ROD DIA	SCREW NO.	WT/ PCS	PCS. IN INNER	PCS. IN OUTER	PCS. IN PALLET
MIRN0238050	2.5"	50/70	18	10	10	0.180	10	100	2800
MIRN0239055	3"	55/80	18	10	10	0.200	10	100	2400

FINISH AVAILABLE - EXB, TEXTURE BLK, EXW, ZP, DUROSIL, EVERBLACK, HSG

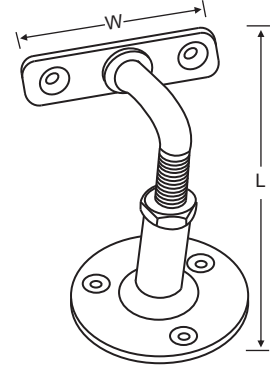

236 : MILD STEEL HANDRAIL BRACKET



TECHNICAL DATA

ITEM CODE	SIZE	LENGTH	TOP PLATE	ROD DIA	SCREW NO.	WT/ PCS	PCS. IN INNER	PCS. IN OUTER	PCS. IN PALLET
MIRN0236063	2.5"	65	60x22	10	8	0.125	10	100	2800
MIRN0236075	3"	77	60x22	10	8	0.136	10	100	2400

FINISH AVAILABLE - EXB, TEXTURE BLK, EXW, ZP, DUROSIL, EVERBLACK, HSG

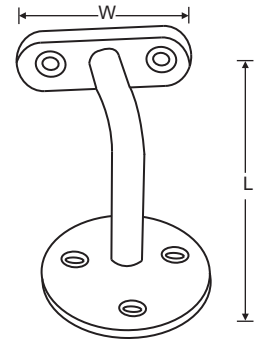

BRASS HANDRAIL BRACKET



TECHNICAL DATA

DPG CODE	ITEM CODE	SIZE	LENGTH	TOP PLATE	BASE PLATE	SCREW NO.	WT/ PCS	PS. IN INNER	PCS. IN OUTER	PCS. IN PALLET
GB0236	BMIH0236065	2.5"	62	45x20	55	7	0.130	10	100	2800
GB0236	BMIH0236076	3"	77	47x20	57	7	0.160	10	80	2400
GB0236H	BMIH236H076	3"	68	51x19	59	7	0.202	10	80	2400

FINISH AVAILABLE - POLISHED & LACQUERED BRASS/CP/SNP

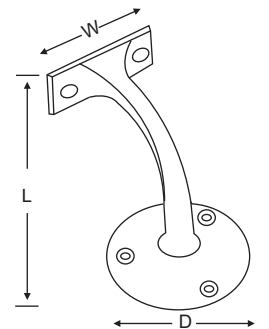

BRASS HEAVY DUTY HANDRAIL BRACKET



TECHNICAL DATA

DPG CODE	ITEM CODE	LENGTH	TOP PLATE	BASE DIA	SCREW NO.	WT/ PCS	PCS. IN INNER	PCS. IN OUTER	PCS. IN PALLET
GB0236S	BMIH236S065	65	47x20	57	6	0.168	10	100	2800

FINISH AVAILABLE - POLISHED & LACQUERED BRASS, CP, SNP

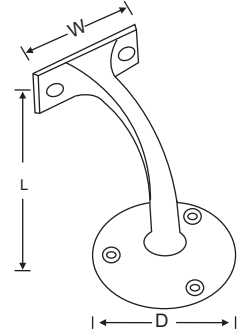

ALUMINIUM HANDRAIL BRACKET



TECHNICAL DATA

DPG CODE	ITEM CODE	LENGTH	TOP PLATE	BASE DIA	SCREW NO.	WT/ PCS	PCS. IN INNER	PCS. IN OUTER	PCS. IN PALLET
GA1475	AMIH1475063	62	50X22	61	8	0.122	10	80	2400

Finish Available : SAA, PAA
Size Available: 3" (GA1476)

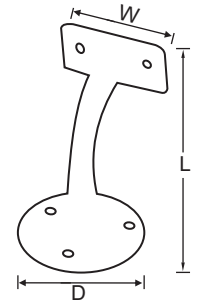

BLACK ANTIQUE HANDRAIL BRACKET



TECHNICAL DATA

DPG CODE	ITEM CODE	LENGTH	TOP PLATE	BASE PLATE	SCREW NO.	WT/ PCS	PCS. IN INNER	PCS. IN OUTER	PCS. IN PALLET
G0236	CMIH0236XXX	65	60X22	58	8	0.280	10	80	2400

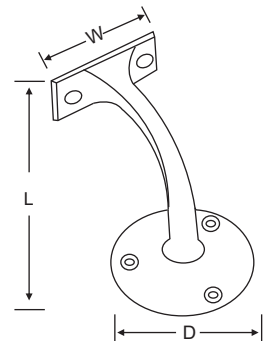

497 : MILD STEEL TOP FLAP STAY



TECHNICAL DATA

ITEM CODE	LENGTH	WIDTH	THICKNESS	SCREW NO.	WT/PCS	PCS. IN INNER	PCS. IN OUTER	PCS. IN PALLET
MIMIHO497150	210	44	2.5	6	0.051	10	200	6400

FINISH AVAILABLE - NP WITH WHITE BOSS

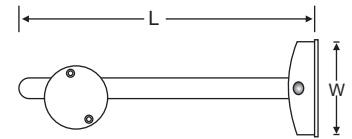

498 : MILD STEEL SOLID LID STAY



TECHNICAL DATA

ITEM CODE	LENGTH	WIDTH	THICKNESS	SCREW NO.	WT/PCS	PCS. IN INNER	PCS. IN OUTER	PCS. IN PALLET
MIMIHO498200	210	44	2.5	6	0.050	10	200	3600

FINISH AVAILABLE - NP

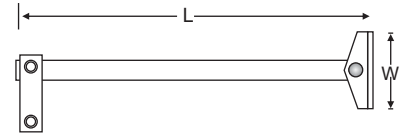

319L : MILD STEEL CORNER BRACES (LIGHT) COUNTER SUNK - INSIDE/OUTSIDE

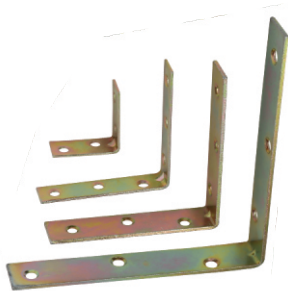

TECHNICAL DATA

ITEM CODE	SIZE	LENGTH	WIDTH	THICKNESS	SCREW NO.	WT/PCS	PCS. IN INNER	PCS. IN OUTER	PCS. IN PALLET
MIRN0319025	1"	25	16	1.6	6	0.009	50	2200	96800
MIRN0319038	1.5"	38	16	1.6	6	0.012	50	1500	60000
MIRN0319050	2"	50	16	1.6	6	0.019	50	1000	39000
MIRN0319065	2.5"	65	16	1.7	6	0.025	50	600	28800
MIRN0319075	3"	75	16	1.7	7	0.030	50	500	12000
MIRN0319100	4"	100	22	2.30	7	0.075	25	250	10000
MIRN0319125	5"	125	22	2.30	7	0.096	25	200	9600
MIRN0319150	6"	150	26	2.5	8	0.145	25	150	7200

FINISH AVAILABLE - EXB, TEXTURE BLK, EXW, ZP, DUROSIL, EVERBLACK, HSG
 Note : 320 Inside Countersunk And 321 Outside Countersunk also available.

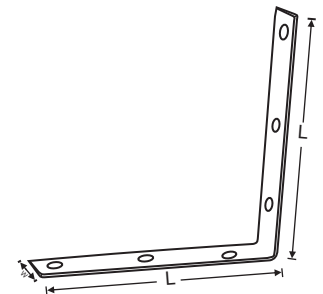

319H : MILD STEEL CORNER BRACES (HEAVY) COUNTER SUNK - INSIDE/OUTSIDE

TECHNICAL DATA



ITEM CODE	SIZE	LENGTH	WIDTH	THICKNESS	SCREW NO.	WT/PCS	PCS. IN INNER	PCS. IN OUTER	PCS. IN PALLET
MIRN0320027	1"	27	16	2.0	6	0.011	50	2200	96800
MIRN0320038	1.5"	39	16	2.0	6	0.015	50	1500	58500
MIRN0320050	2"	52	16	2.0	6	0.021	50	1000	39000
MIRN0320065	2.5"	66	19	2.0	6	0.035	50	600	28800
MIRN0320075	3"	76	19	2.0	6	0.037	50	500	24000
MIRN0320100	4"	101	22	2.5	7	0.082	25	250	10000
MIRN0320125	5"	127	22	2.5	7	0.102	25	200	9000
MIRN0320150	6"	152	25	2.5	7	0.146	25	150	7650

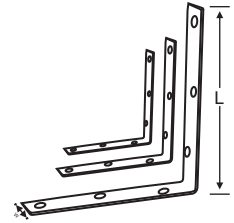

FINISH AVAILABLE - EXB, TEXTURE BLK, EXW, ZP, DUROSIL, EVERBLACK, HSG
 Note : 320 Inside Countersunk And 321 Outside Countersunk also available.

319RC : MILD STEEL ROUND CORNER BRACKET



TECHNICAL DATA

ITEM CODE	SIZE	LENGTH	WIDTH	THICKNESS	SCREW NO.	WT/PCS	PCS. IN INNER	PCS. IN OUTER	PCS. IN PALLET
MIRN0321019	3/4"	19	19	1.0	8	0.004	1000	5000	180000

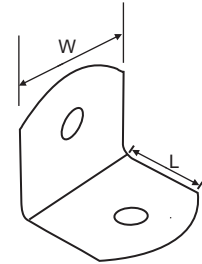

FINISH AVAILABLE - EXB, TEXTURE BLK, EXW, ZP, DUROSIL, EVERBLACK, HSG

218 : MILD STEEL STRETCHER PLATE (LIGHT)



TECHNICAL DATA

ITEM CODE	SIZE	LENGTH	WIDTH W1XW2	THICKNESS	SCREW NO.	WT/PCS	PCS. IN INNER	PCS. IN OUTER	PCS. IN PALLET
MIRN0218025	1"	28	25X25	1.15	6	0.011	100	1000	40000

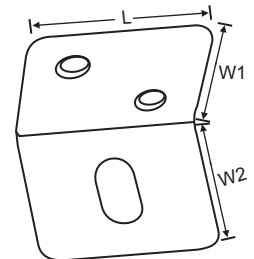

FINISH AVAILABLE - EXB, TEXTURE BLK, EXW, ZP, DUROSIL, EVERBLACK, HSG

315 : MILD STEEL STRETCHER PLATE

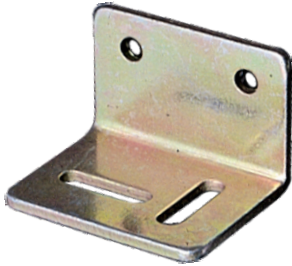

TECHNICAL DATA

ITEM CODE	SIZE	LENGTH	WIDTH W1XW2	THICKNESS	SCREW NO.	WT/ PCS	PCS. IN INNER	PCS. IN OUTER	PCS. IN PALLET
MIRN0315038	1.5"	38	25X29	1.8	8	0.025	100	800	36000

FINISH AVAILABLE - EXB, TEXTURE BLK, EXW, ZP, DUROSIL, EVERBLACK, HSG

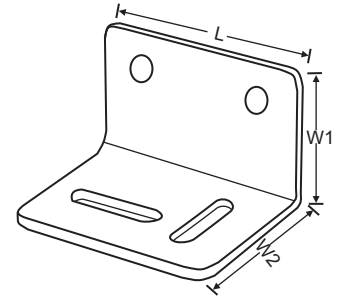

324 : MILD STEEL CORNER PLATE

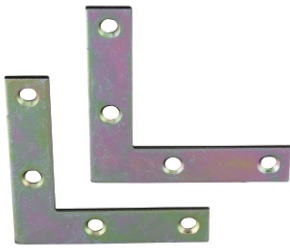

TECHNICAL DATA

ITEM CODE	SIZE	LENGTH	WIDTH	THICKNESS	SCREW NO.	WT/ PCS	PCS. IN INNER	PCS. IN OUTER	PCS. IN PALLET
MIRN0324050	2"	50	13	1.5	6	0.014	50	1500	58500
MIRN0324065	2.5"	67	13	2.0	7	0.022	50	1000	40000
MIRN0324075	3"	78	16	2.0	8	0.035	50	600	28800
MIRN0324100	4"	100	16	2.65	8	0.054	25	400	16000
MIRN0324125	5"	125	19	2.65	8	0.091	25	225	9000
MIRN0324150	6"	150	22	2.65	8	0.122	25	150	6750

FINISH AVAILABLE - EXB, TEXTURE BLK, EXW, ZP, DUROSIL, EVERBLACK, HSG

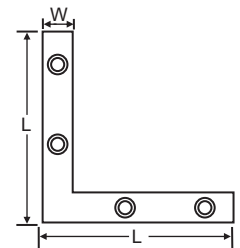

318 : MILD STEEL TEE PLATE

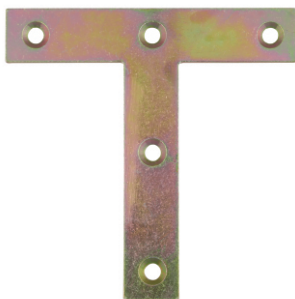

TECHNICAL DATA

ITEM CODE	SIZE	LENGTH	WIDTH	THICKNESS	SCREW NO.	WT/ PCS	PCS. IN INNER	PCS. IN OUTER	PCS. IN PALLET
MIRN0318075	3"	76	16	2.0	8	0.031	25	400	24000
MIRN0318100	4"	100	19	2.0	8	0.052	25	250	15000

FINISH AVAILABLE - EXB, TEXTURE BLK, EXW, ZP, DUROSIL, EVERBLACK, HSG

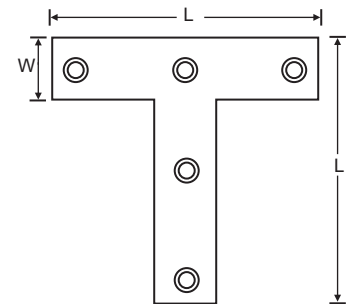

325 : MILD STEEL MENDING PLATE



TECHNICAL DATA

ITEM CODE	SIZE	LENGTH	WIDTH	THICKNESS	SCREW NO.	WT/PCS	PCS. IN INNER	PCS. IN OUTER	PCS. IN PALLET
MIRN0325075	3"	76	16	1.85	7	0.016	50	1000	50000
MIRN0325100	4"	100	16	2.0	7	0.025	50	700	28000
MIRN0325125	5"	126	19	2.5	8	0.042	25	450	18000
MIRN0325150	6"	151	19	2.5	8	0.053	25	300	12600

FINISH AVAILABLE - EXB, TEXTURE BLK, EXW, ZP, DUROSIL, EVERBLACK, HSG

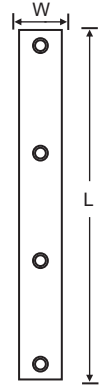

325H : MILD STEEL HEAVY MENDING PLATE



TECHNICAL DATA

ITEM CODE	SIZE	LENGTH	WIDTH	THICKNESS	SCREW NO.	WT/PCS	PCS. IN INNER	PCS. IN OUTER	PCS. IN PALLET
MIRN325H075	3"	75	19	2.5	7	0.025	50	800	28800
MIRN325H100	4"	100	25	2.5	8	0.049	50	400	16000
MIRN325H125	5"	125	25	2.5	9	0.057	25	350	12600
MIRN325H150	6"	150	25	2.5	9	0.070	25	300	12600

FINISH AVAILABLE - EXB, TEXTURE BLK, EXW, ZP, DUROSIL, EVERBLACK, HSG



316/317 : MILD STEEL SLOT PLATE (HEAVY) HORIZONTAL/ VERTICAL

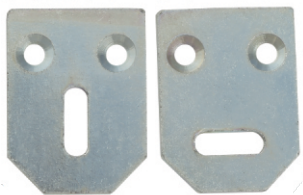

TECHNICAL DATA

ITEM CODE	SIZE	LENGTH	WIDTH	THICKNESS	SCREW NO.	WT/PCS	PCS. IN INNER	PCS. IN OUTER
MIRN0316050	2"	50	38	3.0	10	0.040	100	600
MIRN0317050	2"	50	38	3.0	10	0.040	100	600

FINISH AVAILABLE - EXB, TEXTURE BLK, EXW, ZP, DUROSIL, EVERBLACK, HSG

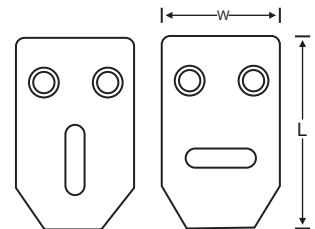

316A/317A : MILD STEEL SLOT PLATE (LIGHT) HORIZONTAL/ VERTICAL



TECHNICAL DATA

ITEM CODE	SIZE	LENGTH	WIDTH	THICKNESS	SCREW NO.	WT/PCS	PCS. IN INNER	PCS. IN OUTER
MIRN0316A045	1.5"	44	32	2.35	8	0.022	100	600
MIRN0317A045	1.5"	44	32	2.35	8	0.022	100	600

FINISH AVAILABLE - EXB, TEXTURE BLK, EXW, ZP, DUROSIL, EVERBLACK, HSG

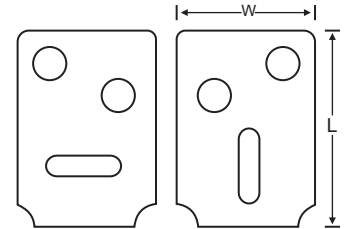

70070 : MILD STEEL FLANGE BRACKET



TECHNICAL DATA

ITEM CODE	SIZE	LENGTH	WIDTH	THICKNESS	SCREW NO.	WT/PCS	PCS. IN INNER	PCS. IN OUTER	PCS. IN PALLET
MIRN7007083	3.25"	83	83	1	4	0.031	50	500	24000

FINISH AVAILABLE - EXB, TEXTURE BLK, EXW, ZP, DUROSIL, EVERBLACK, HSG

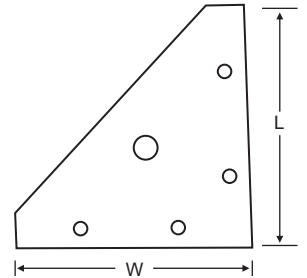

70080 : MILD STEEL CORNER BRACKET



TECHNICAL DATA

ITEM CODE	SIZE	LENGTH	WIDTH	THICKNESS	SCREW NO.	WT/PCS	PCS. IN INNER	PCS. IN OUTER	PCS. IN PALLET
MIRN7008050	2.5"	64	64	1.0	4	0.034	50	500	22500

FINISH AVAILABLE - EXB, TEXTURE BLK, EXW, ZP, DUROSIL, EVERBLACK, HSG

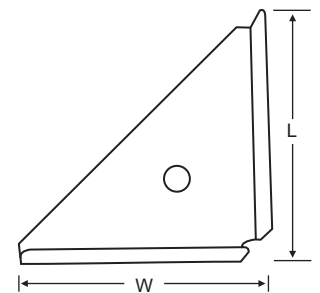

329: MILD STEEL Z BRACKET



TECHNICAL DATA

ITEM CODE	SIZE	LENGTH	WIDTH	THICKNESS	SCREW NO.	WT/PCS	PCS. IN INNER	PCS. IN OUTER	PCS. IN PALLET
MIRN0329035	35MM	68	31	1.0	4	0.034	50	1000	22500
MIRN0330028	28MM	66	28	1.0	4	0.018	50	1000	39000

FINISH AVAILABLE - EXB, TEXTURE BLK, EXW, ZP, DUROSIL, EVERBLACK, HSG

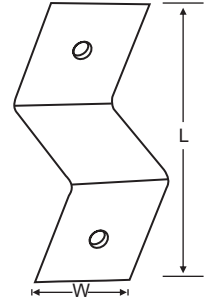

326 : MILD STEEL CONNECTING BRACKET



TECHNICAL DATA

ITEM CODE	SIZE	LENGTH	WIDTH	THICKNESS	SCREW NO.	WT/PCS	PCS. IN INNER	PCS. IN OUTER
MIRN0326050	2"	50	21	1.3	4	0.011	100	1000
MIRN0326075	3"	73	21	1.3	4	0.017	100	1000

FINISH AVAILABLE - EXB, TEXTURE BLK, EXW, ZP, DUROSIL, EVERBLACK, HSG

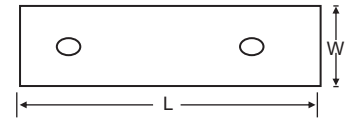

327 : MILD STEEL TWISTED BRACKET



TECHNICAL DATA

ITEM CODE	SIZE	LENGTH	WIDTH	THICKNESS	SCREW NO.	WT/PCS	PCS. IN INNER	PCS. IN OUTER
MIRN0327050	2"	60	18	0.9	4	0.008	100	1000

FINISH AVAILABLE - EXB, TEXTURE BLK, EXW, ZP, DUROSIL, EVERBLACK, HSG

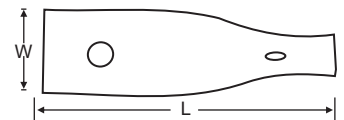

331: MILD STEEL RIDGE PLATE



TECHNICAL DATA

ITEM CODE	SIZE	LENGTH	WIDTH	THICKNESS	SCREW NO.	WT/PCS	PCS. IN INNER	PCS. IN OUTER
MIRN0331038	1.5"	27X26	38	1.4	4	0.025	50	500

FINISH AVAILABLE - EXB, TEXTURE BLK, EXW, ZP, DUROSIL, EVERBLACK, HSG

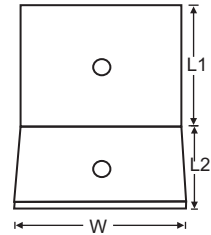

585 : MILD STEEL MIRROR PLATE PLAIN

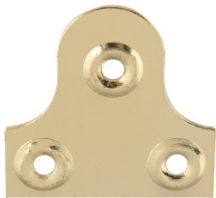

TECHNICAL DATA

ITEM CODE	SIZE	LENGTH	WIDTH	THICKNESS	SCREW NO.	WT/PCS	PCS. IN INNER	PCS. IN OUTER
MIRN0585025	1"	25	27	0.8	4	0.003	100	2000
MIRN0585032	1.25"	32	32	0.8	4	0.005	100	2000
MIRN0585038	1.5"	38	38	0.8	4	0.006	100	2000
MIRN0585050	2"	50	50	0.8	4	0.009	100	2000

FINISH AVAILABLE - EXB, TEXTURE BLK, EXW, ZP, DUROSIL, EVERBLACK, HSG

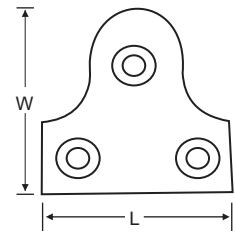

585S : MILD STEEL MIRROR PLATE SLOTTED



TECHNICAL DATA

ITEM CODE	SIZE	LENGTH	WIDTH	THICKNESS	SCREW NO.	WT/PCS	PCS. IN INNER	PCS. IN OUTER
MIRN585S025	1"	25	27	0.8	4	0.003	100	2000
MIRN586S032	1.25"	32	32	0.8	4	0.005	100	2000
MIRN586S038	1.5"	38	38	0.8	4	0.006	100	2000
MIRN586S050	2"	50	50	0.8	4	0.009	100	2000

FINISH AVAILABLE - EXB, TEXTURE BLK, EXW, ZP, DUROSIL, EVERBLACK, HSG

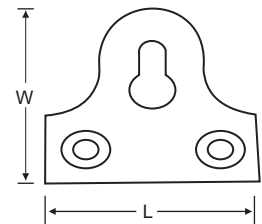

70090 : MILD STEEL MINI MOUNT

TECHNICAL DATA

ITEM CODE	SIZE	LENGTH	WIDTH	THICKNESS	SCREW NO.	WT/PCS	PCS. IN INNER	PCS. IN OUTER
MIRN7009XXX	1.5"	40	16	1.4	4	0.006	100	2000

FINISH AVAILABLE - EXB, TEXTURE BLK, EXW, ZP, DUROSIL, EVERBLACK, HSG

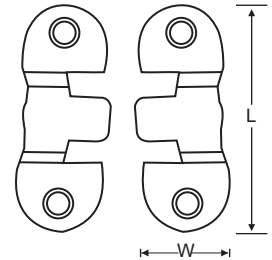

780
LARGE PATTERN TABLE BRACE PLATE

401
TWISTED SUPPORT BRACKET

FINISH AVAILABLE - EXB, TEXTURE BLK, EXW, ZP, DUROSIL, EVERBLACK, HSG

1247 : MILD STEEL FLUTED ANGLE BRACKET
TECHNICAL DATA

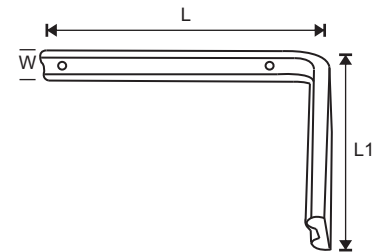
ITEM CODE	SIZE	LENGTH	WIDTH	THICKNESS	SCREW NO.	WT/PCS	PCS. IN OUTER	PCS. IN PALLET
MGF1247075	3"X2"	75X50	20	3.7	8	0.093	20	3760
MGF1247100	4"X3"	100X75	20	3.7	8	0.136	20	2000
MGF1247125	5"X4"	125X100	20	3.7	8	0.180	20	2000
MGF1247150	6"X5"	150X125	25	5.0	8	0.361	20	1000
MGF1247200	8"X6"	200X150	25	5.0	8	0.445	20	900
MGF1247250	10"X8"	250X200	25	5.0	8	0.580	20	720
MGF1247300	12"X10"	300X250	25	5.0	8	0.703	20	720
MGF1247350	14"X12"	350X300	25	5.0	8	0.830	20	720



FINISH AVAILABLE - EXB, TEXTURE BLK, EXW, ZP, DUROSIL, EVERBLACK, HSG

MILD STEEL SHELF BRACKET (LONDON PATTERN)

TECHNICAL DATA

DPG CODE	ITEM CODE	SIZE	LENGTH	WIDTH	THICKNESS	SCREW NO.	WT/ PCS	PCS. IN INNER	PCS. IN OUTER	PCS. IN PALLET
D701	MMIHD701100	4"X3"	100x75	32	1.0	4	0.029	20	240	11520
D702	MMIHD702125	5"X4"	125x100	34	1.0	4	0.040	20	240	9360
D703	MMIHD703150	6"X5"	150x125	34	1.0	4	0.050	20	240	5760
D704	MMIHD704200	8"X6"	200x150	40	1.0	4	0.079	20	160	4800
D705	MMIHD705225	9"X7"	225x175	40	1.0	6	0.097	20	140	2520
D706	MMIHD706250	10"X8"	250x200	42	1.0	6	0.107	20	140	2520
D707	MMIHD707300	12"X10"	300x250	47	1.0	6	0.149	20	100	1800
D708	MMIHD708350	14"X12"	350x300	50	1.0	6	0.174	20	60	1080

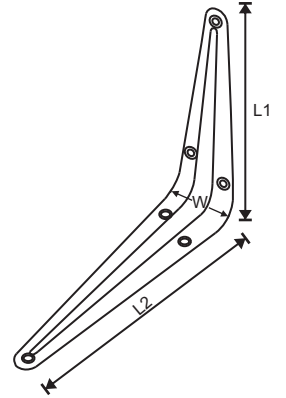

FINISH AVAILABLE - EXW, EXB, EXGR

70050: MILD STEEL CISTERN BRACKET

TECHNICAL DATA

ITEM CODE	SIZE	LENGTH	WIDTH	THICKNESS	SCREW NO.	WT/ PCS	PCS. IN INNER	PCS. IN OUTER
MIRN7050100	4"X4"	100x100	31	1.0	8	0.055	20	160

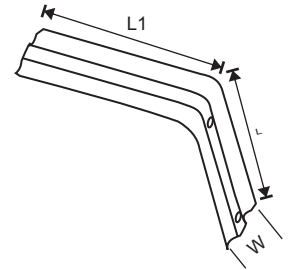

FINISH AVAILABLE - EXB, TEXTURE BLK, EXW, ZP, DUROSIL, EVERBLACK, HSG

BLACK ANTIQUE TURN BUTTON

TECHNICAL DATA

DPG CODE	ITEM CODE	SIZE	LENGTH	WIDTH	SCREW NO.	WT/ PCS	PCS. IN INNER	PCS. IN OUTER	PCS. IN PALLET
G1801	CMIH1801038	1.5"	38	11	7	0.011	100	1000	48000
G1802	CMIH1802050	2"	51	13	8	0.020	50	500	25000
G1803	CMIH1803065	2.5"	65	17	8	0.040	50	400	16800

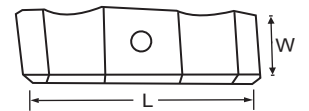

 FINISH AVAILABLE : EXB, DUROSIL, HSG
 SIZE AVAILABLE : 1 1/4" (G1800)

BLACK ANTIQUE WING TURN BUTTON

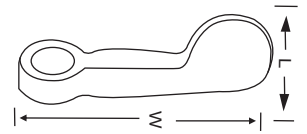

TECHNICAL DATA

DPG CODE	ITEM CODE	SIZE	LENGTH	WIDTH	SCREW NO.	WT/PCS	PCS. IN INNER	PCS. IN OUTER
G1850	CMIH185038	1.5"	40	13	7	0.013	100	1000
G1851	CMIH1851050	2"	50	13	7	0.019	100	1000



FINISH AVAILABLE : EXB, EXW, DUROSIL, HSG

BLACK ANTIQUE HALF TURN BUTTON



TECHNICAL DATA

DPG CODE	ITEM CODE	LENGTH	WIDTH	SCREW NO.	WT/PCS	PCS. IN INNER	PCS. IN OUTER
G1820	CMIH1820030	32	13	8	0.015	100	1000

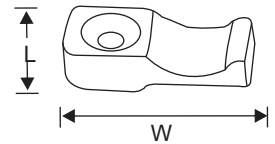

FINISH AVAILABLE : EXB, EXW, DUROSIL, HSG

BLACK ANTIQUE CLEAT HOOK



TECHNICAL DATA

DPG CODE	ITEM CODE	SIZE	LENGTH	WIDTH	SCREW NO.	WT/PCS	PCS. IN INNER	PCS. IN OUTER	PCS. IN PALLET
G2002	CMIH2002075	3"	76	25	6	0.053	30	300	12000
G2003	CMIH2003100	4"	100	25	10	0.070	25	250	10000
G2004	CMIH2004125	5"	128	28	10	0.092	25	250	8000
G2005	CMIH2005150	6"	151	28	10	0.103	25	150	7500

FINISH AVAILABLE : EXB, EXW, DUROSIL, HSG
SIZE AVAILABLE IN 50MM (G2001)



790 : MILD STEEL QUADRANT STAY - LEFT HANDED & RIGHT HANDED



TECHNICAL DATA

ITEM CODE	SIZE	LENGTH	WIDTH	THICKNESS	SCREW NO.	WT/ SET	SET. IN INNER	SET. IN OUTER	SET. IN PALLET
MMIH0790150	6"	176	60	2.6	10	0.180	5	50	2000

FINISH AVAILABLE - EXB, TEXTURE BLK, EXW, ZP, DUROSIL, EVERBLACK, HSG

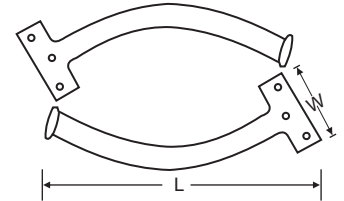

GP039 : MILD STEEL SINGLE SCREW PULLEY



TECHNICAL DATA

ITEM CODE	SIZE	LENGTH	WIDTH	THICKNESS	WHEEL DIA	WT/ PCS	PCS. IN INNER	PCS. IN OUTER	PCS. IN PALLET
MPUL0039045	1.75"	40	62	2	43	0.074	10	100	3600

FINISH AVAILABLE - EXB, TEXTURE BLK, EXW, BZP, DUROSIL, HSG

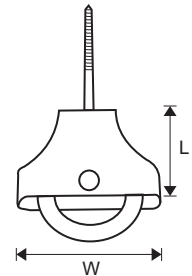

GP042 : MILD STEEL DOUBLE SCREW PULLEY



TECHNICAL DATA

ITEM CODE	SIZE	LENGTH	WIDTH	THICKNESS	WHEEL DIA	WT/ PCS	PCS. IN INNER	PCS. IN OUTER	PCS. IN PALLET
MPUL0042045	1.75"	38	68	2	43	0.115	10	100	3600

FINISH AVAILABLE - EXB, TEXTURE BLK, EXW, BZP, DUROSIL, HSG

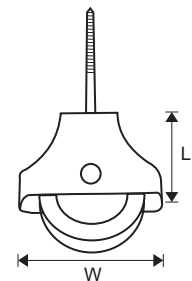

GP260 : MILD STEEL SINGLE CLOTHES LINE PULLEY



TECHNICAL DATA

ITEM CODE	SIZE	LENGTH	WIDTH	THICKNESS	WHEEL DIA	WT/ PCS	PCS. IN INNER	PCS. IN OUTER	PCS. IN PALLET
MPUL0260032	1.25"	114	32	1.9	30	0.097	10	100	3600

FINISH AVAILABLE - EXB, TEXTURE BLK, EXW, BZP, DUROSIL, HSG

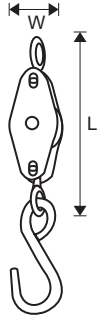

GP260A : MILD STEEL SINGLE CLOTHES LINE PULLEY



TECHNICAL DATA

ITEM CODE	SIZE	LENGTH	WIDTH	THICKNESS	WHEEL DIA	WT/ PCS	PCS. IN INNER	PCS. IN OUTER	PCS. IN PALLET
MPUL260A038	1.5"	120	38	2.2	35	0.115	10	100	3600

FINISH AVAILABLE - EXB, TEXTURE BLK, EXW, BZP, DUROSIL, HSG

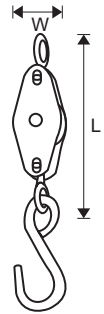

GP202A : MILD STEEL AXLE PULLEY WITH PLATE, NYLON WHEEL FOREND



TECHNICAL DATA

ITEM CODE	SIZE	LENGTH	WIDTH	THICKNESS	WHEEL DIA	WT/ PCS	PCS. IN INNER	PCS. IN OUTER	PCS. IN PALLET
MPUL202A040	1.75"	112	25	3.0	43	0.160	10	100	3600

FINISH AVAILABLE - EXB, TEXTURE BLK, EXW, BZP, DUROSIL, HSG
PLATE FINISHES - EB, CP, SNP

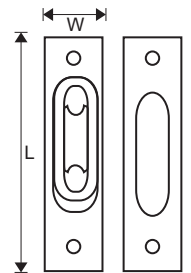

GP202 : MILD STEEL AXLE PULLEY NYLON WHEEL

TECHNICAL DATA

ITEM CODE	SIZE	LENGTH	WIDTH	THICKNESS	SCREW NO.	WHEEL DIA	WT/ PCS	PCS. IN INNER	PCS. IN OUTER	PCS. IN PALLET
MPUL0202040	1.75"	112	25	3.0	8	43	0.110	10	100	3600

FINISH AVAILABLE - EXB, TEXTURE BLK, EXW, ZP, DUROSIL, BZP, HSG

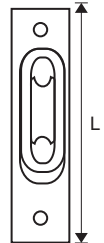
GP202/Q : MILD STEEL ROUND END AXLE PULLEY CAST WHEEL

TECHNICAL DATA

ITEM CODE	SIZE	LENGTH	WIDTH	THICKNESS	SCREW NO.	WHEEL DIA	WT/ PCS	PCS. IN INNER	PCS. IN OUTER	PCS. IN PALLET
MPUL202Q045	1.75"	111	35	5.0	10	43	0.150	10	100	3600

FINISH AVAILABLE - EXB, TEXTURE BLK, EXW, ZP, DUROSIL, BZP, HSG

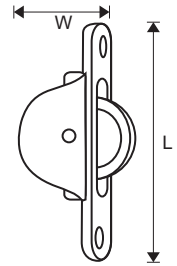
GP261 : MILD STEEL SINGLE LINE (AWNING) PULLEY

TECHNICAL DATA

ITEM CODE	SIZE	LENGTH	WIDTH	THICKNESS	WHEEL DIA	WT/ PCS	PCS. IN INNER	PCS. IN OUTER	PCS. IN PALLET
MPUL0261038	1.5"	100	38	2.2	36	0.084	10	100	3600

FINISH AVAILABLE - EXB, TEXTURE BLK, EXW, ZP, DUROSIL, BZP, HSG

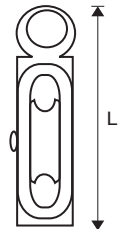

GP268 : MILD STEEL SINGLE UPRIGHT PULLEY - WHEEL ACROSS THE PLATE

TECHNICAL DATA

ITEM CODE	SIZE	LENGTH	WIDTH	THICKNESS	SCREW NO.	WHEEL DIA	WT/ PCS	PCS. IN INNER	PCS. IN OUTER	PCS. IN PALLET
MPUL0268038	1.5"	70	53	2.2	8	35	0.068	10	100	3600

FINISH AVAILABLE - EXB, TEXTURE BLK, EXW, ZP, DUROSIL, BZP, HSG

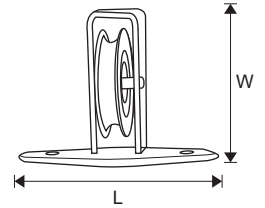
GP268A : MILD STEEL SINGLE UPRIGHT PULLEY WHEEL ALONG THE PLATE

TECHNICAL DATA

ITEM CODE	SIZE	LENGTH	WIDTH	THICKNESS	SCREW NO.	WHEEL DIA	WT/ PCS	PCS. IN INNER	PCS. IN OUTER	PCS. IN PALLET
MPUL268A038	1.5"	70	53	2.2	8	35	0.066	10	100	3600

FINISH AVAILABLE - EXB, TEXTURE BLK, EXW, ZP, DUROSIL, BZP, HSG

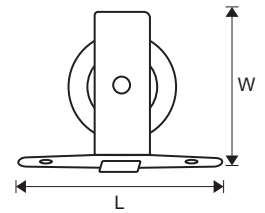
GP202C : CAST IRON SASH PULLEY CAST WHEEL

TECHNICAL DATA

ITEM CODE	SIZE	LENGTH	WIDTH	THICKNESS	SCREW NO.	WHEEL DIA	WT/ PCS	PCS. IN INNER	PCS. IN OUTER	PCS. IN PALLET
MPUL202C044	1.75"	115	35	4.1	10	45	0.214	10	60	3000

FINISH AVAILABLE - EXB, TEXTURE BLK, EXW, ZP, DUROSIL, BZP, HSG

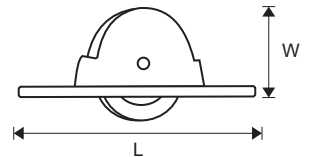

GP202D : MILD STEEL SASH PULLEY WITH BRASS WHEEL



TECHNICAL DATA

ITEM CODE	SIZE	LENGTH	WIDTH	THICKNESS	SCREW NO.	WHEEL DIA	WT/PCS	PCS. IN INNER	PCS. IN OUTER	PCS. IN PALLET
MPUL202D044	1.75"	117	39	3.2	6	46	0.152	10	100	3600

FINISH AVAILABLE - POLISHED BRASS & CHROME PLATED FOREND

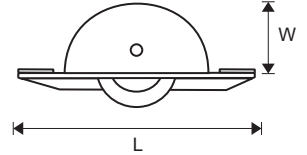

1581 : CAST IRON FAST EYE PULLEY



TECHNICAL DATA

ITEM CODE	SIZE	LENGTH	WIDTH	WHEEL DIA	WT/PCS	PCS. IN INNER	PCS. IN OUTER	PCS. IN PALLET
MPUL1581019	1.5"	75	36	36	0.130	10	100	3600

FINISH AVAILABLE - EXB, TEXTURE BLK, EXW, ZP, DUROSIL, BZP, HSG

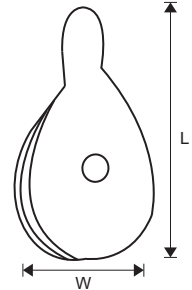

G0051: BLACK ANTIQUE RACK END (LIGHT WEIGHT)



TECHNICAL DATA

ITEM CODE	SIZE	LENGTH	WIDTH	WT/PCS	PCS. IN INNER	PCS. IN OUTER
CMIH0051363	14"	356	93	0.347	5	50

FINISH AVAILABLE : EXB, EXW, DUROSIL

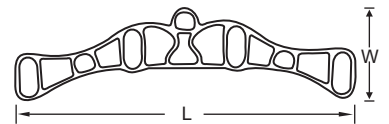

1706: MILD STEEL SPRING DOOR STOP

TECHNICAL DATA

ITEM CODE	LENGTH	WIDTH	SCREW NO.	WT/PCS	PCS. IN INNER	PCS. IN OUTER	PCS. IN PALLET
MMIH1706076	78	24	6	0.027	10	200	12000

FINISH AVAILABLE - ELECTROBRASS, NICKEL PLATED

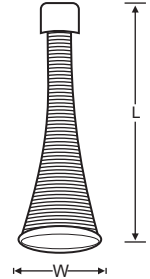
71705 : MILD STEEL DOOR STOPPER

TECHNICAL DATA

ITEM CODE	SIZE	HEIGHT	WIDTH	SCREW NO.	WT/PCS	PCS. IN INNER	PCS. IN OUTER	PCS. IN PALLET
MIRN7175SML	5"	119	12	6	0.098	10	100	4000
MIRN7176LRG	6"	166	30	7	0.216	5	80	3200

FINISH AVAILABLE - EPOXY SILVER, ELECTRO BRASS & CHROME PLATED

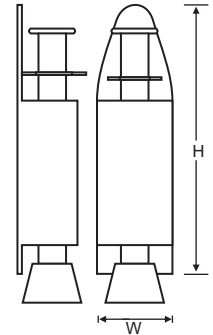
BRASS VICTORIAN PROJECTING DOOR STOP

TECHNICAL DATA

DPG CODE	ITEM CODE	LENGTH	BASE DIA	THICKNESS	SCREW NO.	WT/PCS	PCS. IN INNER	PCS. IN OUTER	PCS. IN PALLET
GB2702	BMIH2702075	76	38	2.6	6	0.073	10	200	6000

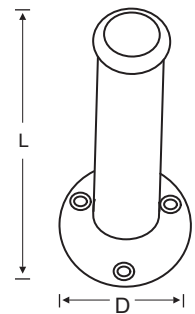
 FINISH AVAILABLE - POLISHED & LACQUERED BRASS/CP/SNP
 Also Available : GB 2701 (2")

BRASS VICTORIAN SKIRTING DOOR STOP



TECHNICAL DATA

DPG CODE	ITEM CODE	LENGTH	WIDTH	THICKNESS	SCREW NO.	WT/ PCS	PCS. IN INNER	PCS. IN OUTER	PCS. IN PALLET
GB2703	BMIH2703063	76	40X40	3.5	6	0.091	10	160	5760

FINISH AVAILABLE - POLISHED & LACQUERED BRASS/CP/SNP

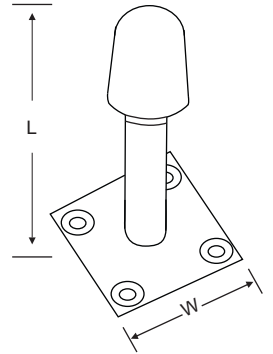

BRASS VICTORIAN OVAL SHIELD DOOR STOP



TECHNICAL DATA

DPG CODE	ITEM CODE	LENGTH	WIDTH	THICKNESS	SCREW NO.	WT/ PCS	PCS. IN INNER	PCS. IN OUTER	PCS. IN PALLET
GB2705	BMIH2705038	48	40	2.6	8	0.092	10	160	5760

FINISH AVAILABLE - POLISHED & LACQUERED BRASS/CP/SNP

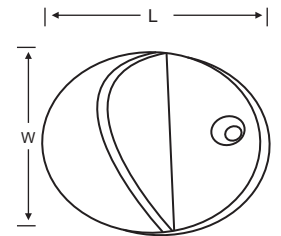

BRASS ROUND SHIELDED DOOR STOP



TECHNICAL DATA

DPG CODE	ITEM CODE	LENGTH	DIA	THICKNESS	SCREW NO.	WT/ PCS	PCS. IN INNER	PCS. IN OUTER	PCS. IN PALLET
GB2707	BMIH2707038	31	38	3.7	7	0.095	10	160	5760

FINISH AVAILABLE - POLISHED & LACQUERED BRASS/CP/SNP

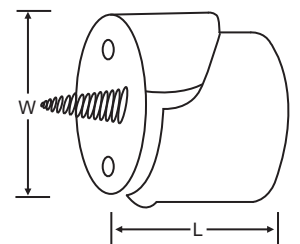

ALUMINIUM TUBULAR DOOR STOP



TECHNICAL DATA

DPG CODE	ITEM CODE	LENGTH	BASE DIAMETER	SCREW NO.	WT/ PCS	PCS. IN INNER	PCS. IN OUTER	PCS. IN PALLET
GA1485	AMIH1485065	73	41	4	0.025	20	200	7200
GA1484	AMIH1484075	86	41	4	0.029	20	200	7200

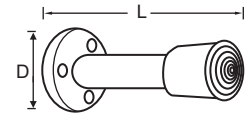

Finish Available : SAA, PAA

ALUMINIUM OVAL SHIELD DOOR STOP



TECHNICAL DATA

DPG CODE	ITEM CODE	LENGTH	WIDTH	THICKNESS	SCREW NO.	WT/ PCS	PCS. IN INNER	PCS. IN OUTER	PCS. IN PALLET
GA1486	AMIH1486XXX	48	41	2.2	6	0.040	10	100	3600

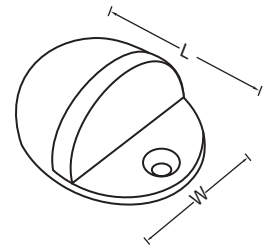

Finish Available : SAA, PAA

ALUMINIUM ROUND SHIELDED DOOR STOP



TECHNICAL DATA

DPG CODE	ITEM CODE	LENGTH	DIA	SCREW NO.	WT/ PCS	PCS. IN INNER	PCS. IN OUTER	PCS. IN PALLET
GA1488	AMIH1488XXX	31	37	7	0.059	10	200	3600

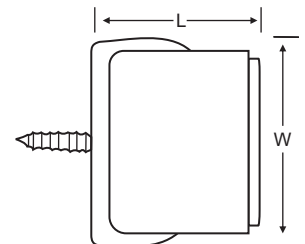

Finish Available : SAA, PAA

GPL0351: RUBBER DOOR WEDGE



TECHNICAL DATA

ITEM CODE	LENGTH	WIDTH	SCREW NO.	WT/PCS	PCS. IN INNER	PCS. IN OUTER
PMIH0351XXX	136	43	6	0.058	20	240

COLOUR AVAILABLE : GREY

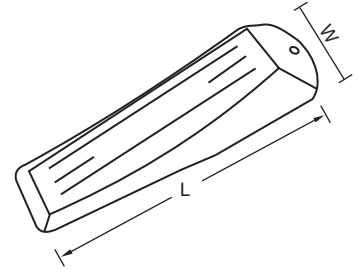

GPL0331: RUBBER DOOR STOP



TECHNICAL DATA

ITEM CODE	HEIGHT	DIAMETER	SCREW NO.	WT/PCS	PCS. IN INNER	PCS. IN OUTER	PCS. IN PALLET
RHIH0331032	21	32	8	0.012	50	500	20000
RHIH0331025	21	26	7	0.010	50	500	20000

COLOUR AVAILABLE : BLACK, WHITE

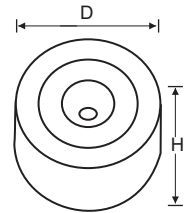

BLACK ANTIQUE DOOR STUD



TECHNICAL DATA

DPG CODE	ITEM CODE	LENGTH	WIDTH	WT/PCS	PCS. IN INNER	PCS. IN OUTER
G1901	CMIH1901019	19	19	0.028	50	500

FINISH AVAILABLE : EXB, DUROSIL

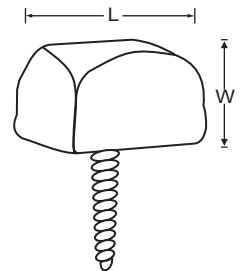

GDC011 : SPRING DOOR CLOSER

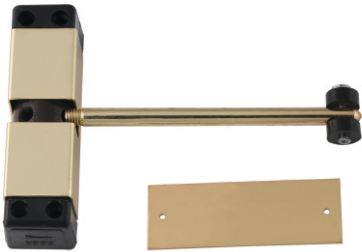

SUITABLE FOR DOOR UPTO 68KG
 Finishes Available : Epoxy White, Satin Nickel Plated
 Brass Plated, Epoxy Black Etc.

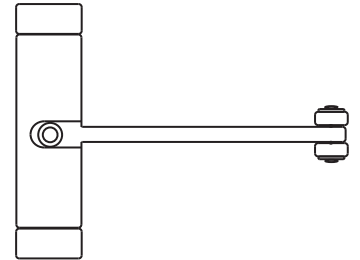

GDC001 : SPRING DOOR CLOSER

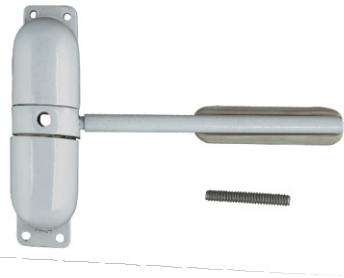

KEEPS THE DOOR CLOSED
 ADJUSTABLE TENSION LEFT RIGHT
 HAND FITTING.
 Suitable for use on doors up to 68 kgs. (150lbs)
 Finishes Available : Epoxy White, Satin Nickel Plated
 Brass Plated, Epoxy Black Etc.

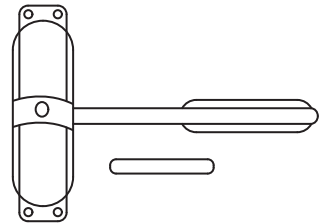

500 : MILD STEEL DOOR SPRING



TECHNICAL DATA

ITEM CODE	SIZE	LENGTH	WIRE DIA	THICKNESS	SCREW NO.	WT/ PCS	PCS. IN INNER	PCS. IN OUTER	PCS. IN PALLET
MGFI0500200	8"	200	4	2.40	8	0.275	5	50	2000
MGFI0500250	10"	250	4	2.40	8	0.337	5	50	1400

FINISH AVAILABLE - EXB, TEXTURE BLK, EXW, ZP, DUROSIL, EVERBLACK, HSG

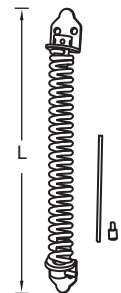

VICTORIAN BRASS LETTER PLATE

TECHNICAL DATA

DPG CODE	ITEM CODE	LENGTH	WIDTH	BOLT	WT/ PCS	PCS. IN INNER	PCS. IN OUTER	PCS. IN PALLET
GB0608	BMIH0608250	255	75	M6	0.444	5	30	1200
GB0612	BMIH0612250	258	98	M6	0.589	5	30	1200
GB0613	BMIH0613300	310	101	M6	0.755	5	20	900
GB0615	BMIH0615400	410	127	M6	1.620	5	10	450

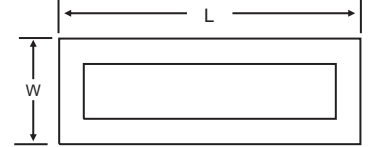

FINISH AVAILABLE - POLISHED & LACQUERED BRASS/CP/SNP
Also Available : GB0614 (14"x5")

VICTORIAN BRASS LETTER PLATE (INTERNAL FLAP COVER)

TECHNICAL DATA

DPG CODE	ITEM CODE	LENGTH	WIDTH	THICKNESS	SCREW NO.	WT/ PCS	PCS. IN INNER	PCS. IN OUTER	PCS. IN PALLET
GB0611	BMIH6110250	260	80	1.0	6	0.282	5	50	1800

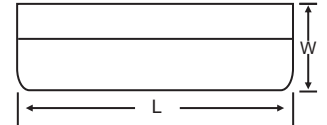

FINISH AVAILABLE - POLISHED & LACQUERED BRASS/CP/SNP, POLISHED
STAINLESS STEEL & SATIN STAINLESS STEEL

VICTORIAN BRASS LETTER PLATE (WITH KNOCKER)

TECHNICAL DATA

DPG CODE	ITEM CODE	LENGTH	WIDTH	BOLT	WT/ PCS	PCS. IN INNER	PCS. IN OUTER	PCS. IN PALLET
GB0609	BMIH0609250	256	78	M6	0.588	5	30	1200

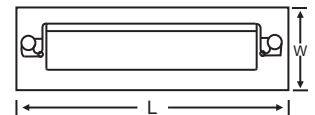

FINISH AVAILABLE - POLISHED & LACQUERED BRASS/CP/SNP

BRASS GEORGIAN POSTAL KNOCKER



TECHNICAL DATA

DPG CODE	ITEM CODE	LENGTH	WIDTH	BOLT	WT/PCS	PCS. IN INNER	PCS. IN OUTER
GB0604	BMIH0604250	256	73	M6	0.684	5	20

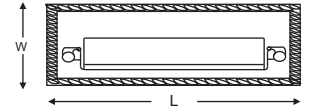

FINISH AVAILABLE - POLISHED & LACQUERED BRASS/CP/SNP

BRASS GEORGIAN LETTER PLATE



TECHNICAL DATA

DPG CODE	ITEM CODE	LENGTH	WIDTH	BOLT	WT/PCS	PCS. IN INNER	PCS. IN OUTER
GB0607	BMIH0607250	258	78	M6	0.531	5	30

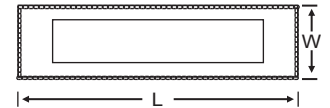

FINISH AVAILABLE - POLISHED & LACQUERED BRASS/CP/SNP
ALSO AVAILABLE GB0606 (11"x3.5")

ALUMINIUM FRONT FIX LETTER PLATE



TECHNICAL DATA

DPG CODE	ITEM CODE	LENGTH	WIDTH	SCREW NO.	WT/PCS	PCS. IN INNER	PCS. IN OUTER	PCS. IN PALLET
GA1201	AMIH1201250	255	78	6	0.160	5	50	1400
GA1202	AMIH1202300	305	78	6	0.200	5	50	1400

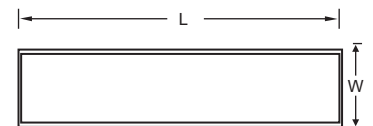

Finish Available : SAA, PAA

ALUMINIUM FRONT FIX LETTER PLATE & TIDY



TECHNICAL DATA

DPG CODE	ITEM CODE	LENGTH	WIDTH	SCREW NO.	WT/PCS	PCS. IN INNER	PCS. IN OUTER
GA1201T	AMIH120350	255	79	6	0.311	1	25

Finish Available : SAA, PAA

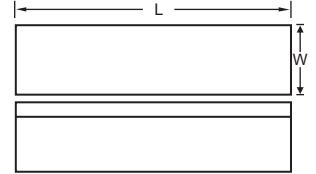

ALUMINIUM REAR FIX LETTER PLATE



TECHNICAL DATA

DPG CODE	ITEM CODE	LENGTH	WIDTH	SCREW NO.	WT/PCS	PCS. IN INNER	PCS. IN OUTER
GA1211	AMIH1211250	252	76	M6	0.153	5	50

Finish Available : SAA, PAA

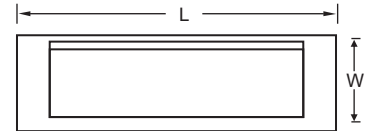

ALUMINIUM INNER FLAP



TECHNICAL DATA

DPG CODE	ITEM CODE	LENGTH	WIDTH	SCREW NO.	WT/PCS	PCS. IN INNER	PCS. IN OUTER	PCS. IN PALLET
GA1221	AMIH1221250	251	68	6	0.106	5	50	1400
GA1222	AMIH1222300	305	68	6	0.119	5	50	1400

Finish Available : SAA, PAA

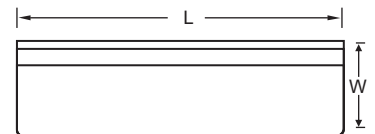

BLACK ANTIQUE LETTER PLATE PLAIN

TECHNICAL DATA

DPG CODE	ITEM CODE	LENGTH	WIDTH	BOLT	WT/PCS	PCS. IN INNER	PCS. IN OUTER
G0402	CMIH0402250	250	83	M6	0.710	2	16
G0060	CMIH0060254	268	88	M6	1.106	2	16
G0405	CMIH0405250	250	100	M6	1.200	2	16

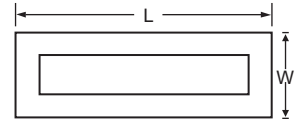

FINISH AVAILABLE : EXB, DUROSIL

BLACK ANTIQUE GEORGIAN LETTER PLATE

TECHNICAL DATA

DPG CODE	ITEM CODE	LENGTH	WIDTH	BOLT	WT/PCS	PCS. IN INNER	PCS. IN OUTER
G0065	CMIH0065254	246	76	M6	0.765	5	20

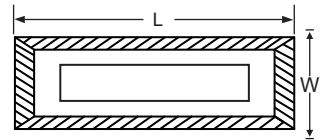

FINISH AVAILABLE : EXB, DUROSIL

BLACK ANTIQUE FLEUR - DE - LYS ORNATE LETTER PLATE

TECHNICAL DATA

DPG CODE	ITEM CODE	LENGTH	WIDTH	BOLT	WT/PCS	PCS. IN INNER	PCS. IN OUTER
G0404A	CMIH0404A350	360	80	M6	0.801	5	20

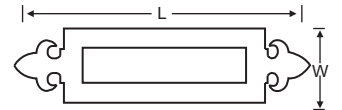

FINISH AVAILABLE : EXB, DUROSIL
 SIZE AVAILABLE : 10" X 4" (G0401), 11"X 4" (G0403) ,14" X 3 1/2" (G0404)

GPV021: UPVC LETTER PLATE

TECHNICAL DATA

ITEM CODE	LENGTH	WIDTH	SCREW NO.	WT/PCS	PCS. IN INNER	PCS. IN OUTER
HMIHPV21250	260	72	7	0.354	5	40

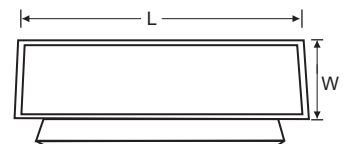

FINISH AVAILABLE : ELECTRO BRASS PLATED, EPOXY WHITE,
 SATIN NICKEL, CHROME PLATED

BRASS VICTORIAN CYLINDER DOOR PULL



TECHNICAL DATA

DPG CODE	ITEM CODE	LENGTH	WIDTH	WT/PCS	PCS. IN INNER	PCS. IN OUTER
GB0850	BMIH0850076	79	41	0.074	20	200

FINISH AVAILABLE - POLISHED & LACQUERED BRASS/CP/SNP

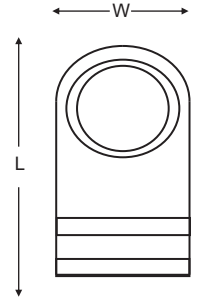

BRASS GEORGIAN CYLINDER DOOR PULL



TECHNICAL DATA

DPG CODE	ITEM CODE	LENGTH	WIDTH	WT/PCS	PCS. IN INNER	PCS. IN OUTER
GB0860	BMIH0860080	81	45	0.081	10	200

FINISH AVAILABLE - POLISHED & LACQUERED BRASS/CP/SNP

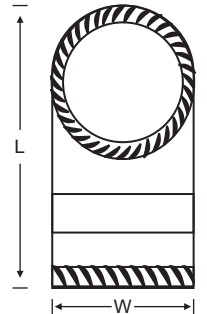

ALUMINIUM CYLINDER PULL



TECHNICAL DATA

DPG CODE	ITEM CODE	LENGTH	WIDTH	WT/PCS	PCS. IN INNER	PCS. IN OUTER	PCS. IN OUTER
GA1421	AMIH1421064	72	44	0.025	20	400	25600

Finish Available : SAA, PAA

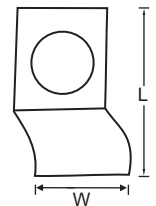

ALUMINIUM CYLINDER PULL



TECHNICAL DATA

NAME	DPG CODE	ITEM CODE	LENGTH	WIDTH	THICKNESS	SCREW NO.	WT/PCS	PCS. IN INNER	PCS. IN OUTER
EURO PROFILE	GA1423	AMIH1423096	96	43	1.9	7	0.021	20	200
OVAL PROFILE	GA1425	AMIH1425096	96	43	1.9	7	0.020	20	200

Finish Available : SAA, PAA

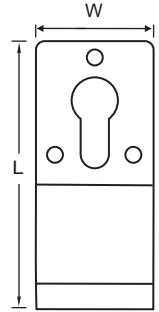

BRASS VICTORIAN OBLONG BELL PUSH



TECHNICAL DATA

DPG CODE	ITEM CODE	LENGTH	WIDTH	SCREW NO.	WT/PCS	PCS. IN INNER	PCS. IN OUTER
GB0881	BMIH0881075	75	26	4	0.059	20	200

FINISH AVAILABLE - POLISHED & LACQUERED BRASS/CP/SNP

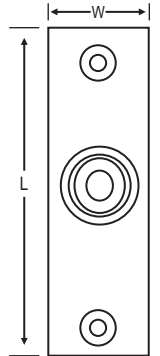

BLACK ANTIQUE BELL PUSH WITH FITTINGS



TECHNICAL DATA

DPG CODE	ITEM CODE	LENGTH	WIDTH	SCREW NO.	WT/PCS	PCS. IN INNER	PCS. IN OUTER
G1700	CMIH1700122	132	33	7	0.110	20	160

FINISH AVAILABLE : EXB, DUROSIL

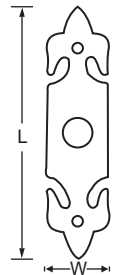

BLACK ANTIQUE BELL PUSH PLATE



TECHNICAL DATA

DPG CODE	ITEM CODE	LENGTH	WIDTH	SCREW NO.	WT/PCS	PCS. IN INNER	PCS. IN OUTER
G1701	CMIH1701XXX	132	33	7	0.085	20	200

FINISH AVAILABLE : EXB, DUROSIL

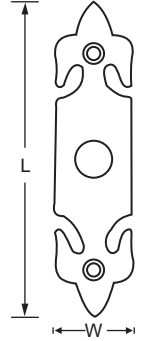

BRASS GEORGIAN DOOR KNOCKER



TECHNICAL DATA

DPG CODE	ITEM CODE	LENGTH	WIDTH	SCREW NO.	WT/PCS	PCS. IN INNER	PCS. IN OUTER
GB2501	BMIH2501165	178	77	M6	0.221	10	80

FINISH AVAILABLE - POLISHED & LACQUERED BRASS/CP/SNP

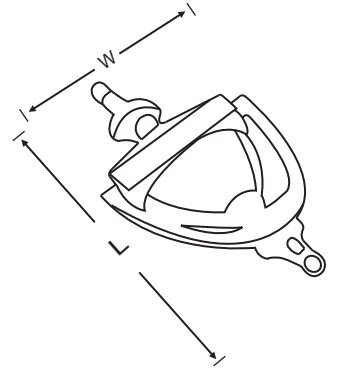

BRASS VICTORIAN URN DOOR KNOCKER



TECHNICAL DATA

DPG CODE	ITEM CODE	LENGTH	WIDTH	SCREW NO.	WT/PCS	PCS. IN INNER	PCS. IN OUTER
GB 2502	BMIH2502170	170	75	M6	0.178	10	100

FINISH AVAILABLE - POLISHED BR/CP

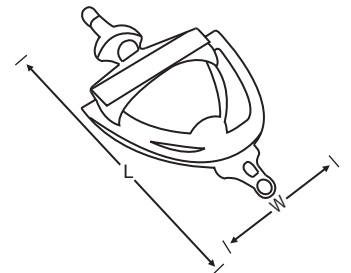

BLACK ANTIQUE LION HEAD DOOR KNOCKER



TECHNICAL DATA

DPG CODE	ITEM CODE	LENGTH	WIDTH	SCREW NO.	WT/PCS	PCS. IN INNER	PCS. IN OUTER
G0120	CMIH0120159	155	93	M6	0.683	5	25

FINISH AVAILABLE : EXB, DUROSIL



BLACK ANTIQUE LION KNOCKER WITH SQUARE PLATE



TECHNICAL DATA

DPG CODE	ITEM CODE	LENGTH	WIDTH	SCREW NO.	WT/PCS	PCS. IN INNER	PCS. IN OUTER
G1402	CMIH1402154	154	94	M6	0.660	5	25

FINISH AVAILABLE : EXB, DUROSIL



BLACK ANTIQUE LION KNOCKER WITH ROUND PLATE



TECHNICAL DATA

DPG CODE	ITEM CODE	LENGTH	WIDTH	SCREW NO.	WT/PCS	PCS. IN INNER	PCS. IN OUTER
G1403	CMIH1403154	154	94	M6	0.650	5	25

FINISH AVAILABLE : EXB, DUROSIL

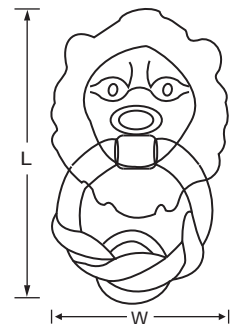

BLACK ANTIQUE LION LIGHT DOOR KNOCKER



TECHNICAL DATA

DPG CODE	ITEM CODE	LENGTH	WIDTH	SCREW NO.	WT/PCS	PCS. IN INNER	PCS. IN OUTER
G1401	CMIH1401132	132	93	M6	0.495	5	30

FINISH AVAILABLE : EXB, DUROSIL

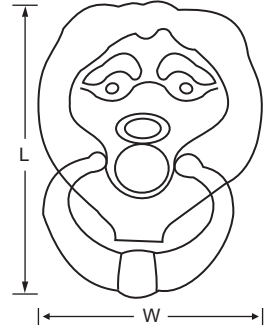

BLACK ANTIQUE FLEUR - DE - LYS RING KNOCKER



TECHNICAL DATA

DPG CODE	ITEM CODE	LENGTH	WIDTH	SCREW NO.	WT/PCS	PCS. IN INNER	PCS. IN OUTER
G1404	CMIH1404125	124	93	M6	0.625	5	30

FINISH AVAILABLE : EXB, DUROSIL

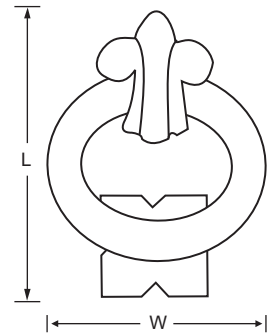

BLACK ANTIQUE RING KNOCKER



TECHNICAL DATA

DPG CODE	ITEM CODE	LENGTH	WIDTH	SCREW NO.	WT/PCS	PCS. IN INNER	PCS. IN OUTER
G0140	CMIH0140159	126	94	M6	0.504	5	30

FINISH AVAILABLE : EXB, DUROSIL

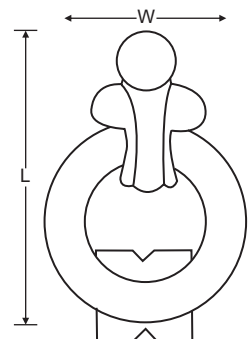

BRASS VICTORIAN FINGER PLATE

TECHNICAL DATA

DPG CODE	ITEM CODE	LENGTH	WIDTH	THICKNESS	SCREW NO.	WT/PCS	PCS. IN INNER	PCS. IN OUTER
GB2900	BMIH2900300	306	76	1.0	4	0.179	10	100

FINISH AVAILABLE - POLISHED & LACQUERED BRASS/CP/SNP
OTHER SIZES, PUSH, PULL VERSIONS ALSO AVAILABLE ON REQUEST

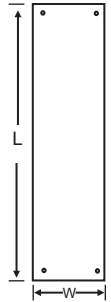
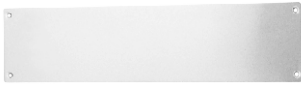
ALUMINIUM KICK PLATE ROUND EDGES COUNTERSUNK HOLES

TECHNICAL DATA

DPG CODE	ITEM CODE	LENGTH	WIDTH	THICKNESS	SCREW NO.	WT/PCS	PCS. IN INNER	PCS. IN OUTER
GA1141	AMIH1141750	750	152	1.2	4	0.342	10	50
GA1142	AMIH1141825	825	152	1.2	4	0.392	10	50
GA1143	AMIH1141850	850	200	1.2	4	0.482	10	50
GA1144	AMIH1141900	900	152	1.2	4	0.420	10	50

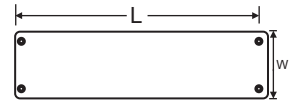
Finish Available : SAA, PAA
Note : Other Sizes Available on Request

ALUMINIUM FINGER PLATE

TECHNICAL DATA

NAME	DPG CODE	ITEM CODE	LENGTH	WIDTH	THICKNESS	SCREW NO.	WT/PCS	PCS. IN INNER	PCS. IN OUTER
FINGER PLATE	GA1101	AMIH1101300	300	75	1.25	4	0.074	10	100
PUSH	GA1121	AMIH1121305	300	75	1.25	4	0.074	10	100
PULL	GA1131	AMIH1131305	300	75	1.25	4	0.074	10	100

Finish Available : SAA, PAA



BRASS VICTORIAN HAT AND COAT HOOK



TECHNICAL DATA

DPG CODE	ITEM CODE	LENGTH	WIDTH	THICKNESS	SCREW NO.	WT/ PCS	PCS. IN INNER	PCS. IN OUTER	PCS. IN PALLET
GB0801	BMIH0801125	126	30	2.6	6	0.072	10	200	6000

FINISH AVAILABLE - POLISHED & LACQUERED BRASS/CP/SNP

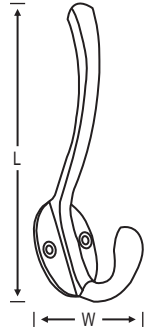

BRASS VICTORIAN HAT AND COAT HOOK HEAVY DUTY



TECHNICAL DATA

DPG CODE	ITEM CODE	LENGTH	WIDTH	THICKNESS	SCREW NO.	WT/ PCS	PCS. IN INNER	PCS. IN OUTER	PCS. IN PALLET
GB0806	BMIH0806150	160	39	2.8	6	0.103	10	160	5760

FINISH AVAILABLE - POLISHED & LACQUERED BRASS/CP/SNP

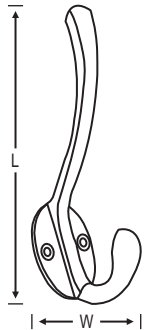

BRASS VICTORIAN WARDROBE SINGLE HOOKS



TECHNICAL DATA

DPG CODE	ITEM CODE	LENGTH	WIDTH	THICKNESS	SCREW NO.	WT/ PCS	PCS. IN INNER	PCS. IN OUTER	PCS. IN PALLET
GB0811	BMIH0811050	46	40	3.0	4	0.027	20	500	12000

FINISH AVAILABLE - POLISHED & LACQUERED BRASS/CP/SNP

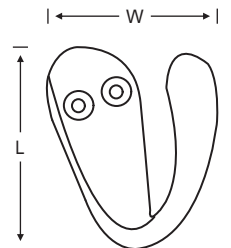

BRASS VICTORIAN SASH LIFT



TECHNICAL DATA

DPG CODE	ITEM CODE	HEIGHT	WIDTH	THICKNESS	SCREW NO.	WT/PCS	PCS. IN INNER	PCS. IN OUTER
GB0851	BMIH0851050	51	51	6.0	6	0.045	20	250

FINISH AVAILABLE - POLISHED & LACQUERED BRASS/CP/SNP

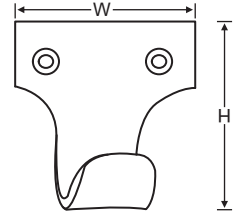

BRASS VICTORIAN WARDROBE DOUBLE HOOK



TECHNICAL DATA

DPG CODE	ITEM CODE	HEIGHT	WIDTH	THICKNESS	SCREW NO.	WT/PCS	PCS. IN INNER	PCS. IN OUTER	PCS. IN PALLET
GB0812	BMIH0812050	72	38	2.9	6	0.047	20	250	12000

FINISH AVAILABLE - POLISHED & LACQUERED BRASS/CP/SNP

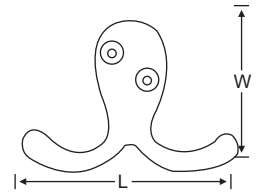

BRASS CURTAIN TIE BACK ROSETTE & PLATE



TECHNICAL DATA

DPG CODE	ITEM CODE	LENGTH	WIDTH	WT/PCS	PCS. IN INNER	PCS. IN OUTER
GB0805	BMIH0805038	38	32	0.021	50	500

FINISH AVAILABLE - POLISHED & LACQUERED BRASS/CP/SNP

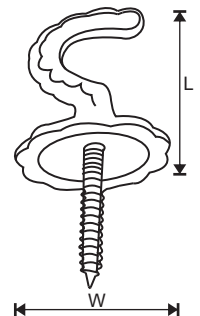

ALUMINIUM HAT & COAT HOOK



TECHNICAL DATA

DPG CODE	ITEM CODE	LENGTH	WIDTH	THICKNESS	SCREW NO.	WT/PCS	PCS. IN INNER	PCS. IN OUTER	PCS. IN PALLET
GA1481	BMIH1481125	131	19	2.6	7	0.021	50	500	12000

Finish Available : SAA, PAA



ALUMINIUM WARDROBE HOOK



TECHNICAL DATA

DPG CODE	ITEM CODE	LENGTH	WIDTH	THICKNESS	SCREW NO.	WT/PCS	PCS. IN INNER	PCS. IN OUTER	PCS. IN PALLET
GA 1482	AMIH1482050	46	19	2.5	6	0.008	50	500	18000

Finish Available : SAA, PAA

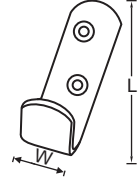

ALUMINIUM SASH LIFT



TECHNICAL DATA

DPG CODE	ITEM CODE	HEIGHT	WIDTH	THICKNESS	SCREW NO.	WT/PCS	PCS. IN INNER	PCS. IN OUTER
GA 1851	AMIH1851050	51	43	1.4	6	0.008	20	500

Finish Available : SAA, PAA
Size Available : HEAVY (GA1852)

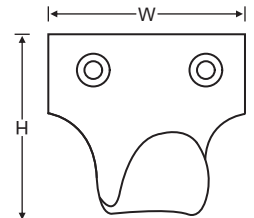

BLACK ANTIQUE HAT AND COAT HOOK SQUARE PLATE



TECHNICAL DATA

DPG CODE	ITEM CODE	LENGTH	WIDTH	SCREW NO.	WT/PCS	PCS. IN INNER	PCS. IN OUTER
G0400	CMIH0400150	145	40	7	0.171	10	100

FINISH AVAILABLE : EXB, DUROSIL

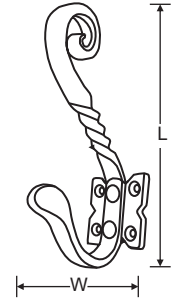

BLACK ANTIQUE HAT & COAT HOOK OVAL PLATE



TECHNICAL DATA

DPG CODE	ITEM CODE	LENGTH	WIDTH	SCREW NO.	WT/PCS	PCS. IN INNER	PCS. IN OUTER
G0706	CMIH0706125	138	36	7	0.132	10	140

FINISH AVAILABLE : EXB, DUROSIL

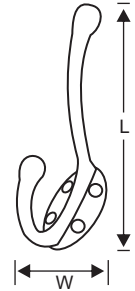

BLACK ANTIQUE ROBE HOOK



TECHNICAL DATA

DPG CODE	ITEM CODE	LENGTH	WIDTH	SCREW NO.	WT/PCS	PCS. IN INNER	PCS. IN OUTER
G0402A	CMIH402A050	60	40	7	0.110	10	200

FINISH AVAILABLE : EXB, DUROSIL

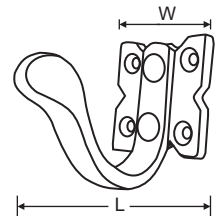

BLACK ANTIQUE ROBE HOOK DOUBLE



TECHNICAL DATA

DPG CODE	ITEM CODE	LENGTH	WIDTH	SCREW NO.	WT/PCS	PCS. IN INNER	PCS. IN OUTER
G0705	CMIH0705XXX	75	40	7	0.097	10	200

FINISH AVAILABLE : EXB, DUROSIL

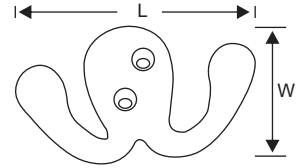

MILD STEEL COWTIE HOOK



TECHNICAL DATA

DPG CODE	ITEM CODE	LENGTH	WIDTH	DIAMETER	WT/PCS	PCS. IN INNER	PCS. IN OUTER
G0710	CMIH071073	72	27	9.0	0.060	20	250

FINISH AVAILABLE - EXB,

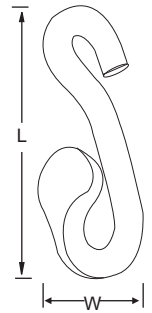

BLACK ANTIQUE CUPBOARD LATCH SET



TECHNICAL DATA

DPG CODE	ITEM CODE	LENGTH	WIDTH	SCREW NO.	WT/PCS	PCS. IN INNER	PCS. IN OUTER
G0492	CLAL0492070	52	76	8	0.226	10	80

FINISH AVAILABLE : EXB, DUROSIL

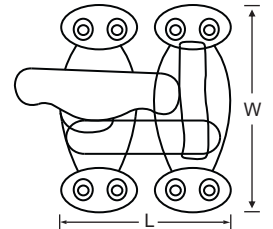

G0701 :



BLACK ANTIQUE ORNATE WARDROBE HOOK

G0494 :



BLACK ANTIQUE RING CABINET PULL (70MM)

G0702:



BLACK ANTIQUE BALL CURTAIN TIE BACK

GZC3001 : ZINC DIE CAST POLE HOOK



TECHNICAL DATA

ITEM CODE	LENGTH	WIDTH	DIAMETER	WT/PCS	PCS. IN INNER	PCS. IN OUTER
ZMIH3001XXX	112	72	27	0.091	10	100

FINISH AVAILABLE - ELECTRO BRASS, CHROME

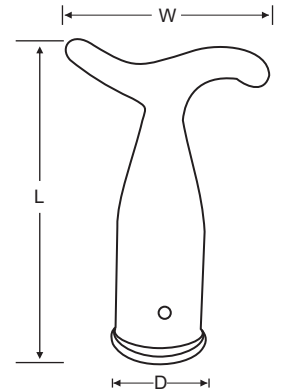

BRASS POLE HOOK



TECHNICAL DATA

DPG CODE	ITEM CODE	LENGTH	WIDTH	DIA	SCREW NO.	WT/PCS	PCS. IN INNER	PCS. IN OUTER
GB0821	BMIH0821112	112	74	28	4	0.123	10	120

FINISH AVAILABLE - POLISHED & LACQUERED BRASS/CP/SNP

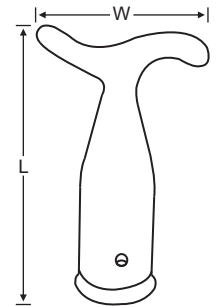

BRASS RING FLUSH PULL



TECHNICAL DATA

DPG CODE	ITEM CODE	LENGTH	WIDTH	THICKNESS	SCREW NO.	WT/PCS	PCS. IN INNER	PCS. IN OUTER
GB0931	BMIH0931050	53	38	2.2	6	0.053	20	200
GB0932	BMIH0931063	64	50	2.5	6	0.104	10	160

FINISH AVAILABLE - POLISHED & LACQUERED BRASS/CP/SNP

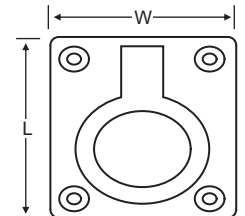

BRASS FLUSH PULL



TECHNICAL DATA

DPG CODE	ITEM CODE	LENGTH	WIDTH	THICKNESS	SCREW NO.	WT/PCS	PCS. IN INNER	PCS. IN OUTER
GB0455A	BMIH0456085	100	38	1.0	4	0.037	200	400

FINISH AVAILABLE - POLISHED & LACQUERED BRASS/CP/SNP

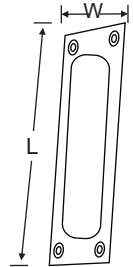

BRASS FLUSH PULL



TECHNICAL DATA

DPG CODE	ITEM CODE	LENGTH	WIDTH	THICKNESS	SCREW NO.	WT/PCS	PCS. IN INNER	PCS. IN OUTER
GB0459	BMIH0459089	87	27	2.7	4	0.060	10	200

FINISH AVAILABLE - POLISHED & LACQUERED BRASS/CP/SNP

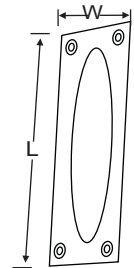

BRASS HOODED DRAWER PULL



TECHNICAL DATA

DPG CODE	ITEM CODE	LENGTH	WIDTH	SCREW NO.	WT/PCS	PCS. IN INNER	PCS. IN OUTER
GB0951	BMIH0951080	100	40	6	0.079	20	200

FINISH AVAILABLE - POLISHED & LACQUERED BRASS/CP/SNP

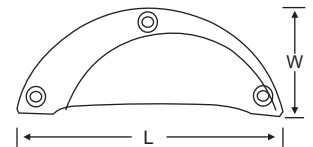

ALUMINIUM FLUSH PULL



TECHNICAL DATA

DPG CODE	ITEM CODE	LENGTH	WIDTH	SCREW NO.	WT/PCS	PCS. IN INNER	PCS. IN OUTER
GA1451	AMIH1451090	89	42	4	0.020	10	200

Finish Available : SAA, PAA

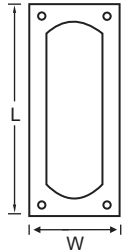

BLACK ANTIQUE ORNAMENT DRAWER PULL



TECHNICAL DATA

DPG CODE	ITEM CODE	LENGTH	WIDTH	SCREW NO.	WT/PCS	PCS. IN INNER	PCS. IN OUTER
G1601	CMIH1601100	102	44	7	0.115	10	160

FINISH AVAILABLE : EXB, DUROSIL

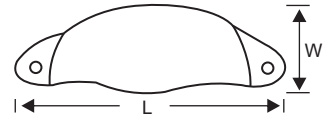

BLACK ANTIQUE DRAWER PULL



TECHNICAL DATA

DPG CODE	ITEM CODE	LENGTH	WIDTH	SCREW NO.	WT/PCS	PCS. IN INNER	PCS. IN OUTER
G0497	CMIH0497089	94	42	7	0.102	10	108

FINISH AVAILABLE : EXB, DUROSIL

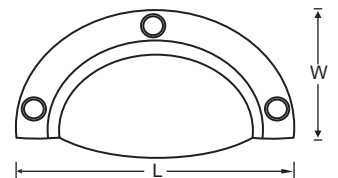

ALUMINIUM TOILET ROLL HOLDER



TECHNICAL DATA

DPG CODE	ITEM CODE	LENGTH	WIDTH	THICKNESS	SCREW NO.	WT/PCS	PCS. IN INNER	PCS. IN OUTER	PCS. IN PALLET
GA1483	AMIH1483XXX	135	81	2.7	8	0.053	10	100	2400

Finish Available : SAA, PAA

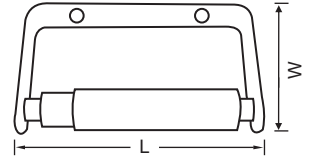

PLASTIC TOILET ROLLER



TECHNICAL DATA

DPG CODE	ITEM CODE	LENGTH	BIG DIA.	SMALL DIA.	WT/PCS	PCS. IN INNER	PCS. IN OUTER
GA1483A	PMIH1483XXX	140	22	18	0.015	10	100

Finish Available : BLACK

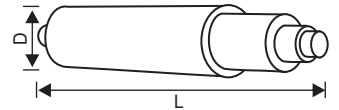

74103: MILD STEEL TURN BUCKLE



TECHNICAL DATA

ITEM CODE	LENGTH	WIDTH	BOLT	WT/PCS	PCS. IN INNER	PCS. IN OUTER
MIRN7410XXX	108	22	M8	0.114	10	100
MIRN7411XXX	119	24	M10	0.175	10	80
MIRN7412XXX	128	31	M12	0.388	5	50

FINISH AVAILABLE - BZP, HSG

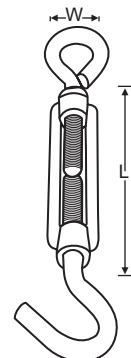

GFX5012 : MILD STEEL SCREW EYE



TECHNICAL DATA

ITEM CODE	SIZE	LENGTH	WIDTH	WIRE DIA	WT/PCS	PCS. IN INNER	PCS. IN OUTER
MFNR5012075	3"	76	35	7.0	0.040	10	300
MFNR5012100	4"	102	35	7.0	0.050	10	300
MFNR5012125	5"	127	35	7.0	0.060	10	300
MFNR5012150	6"	152	35	7.0	0.071	10	200

FINISH AVAILABLE - BZP

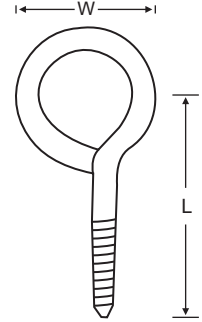

GFX5001 : MILD STEEL SCREW HOOK



TECHNICAL DATA

ITEM CODE	SIZE	LENGTH	WIDTH	WIRE DIA	WT/PCS	PCS. IN INNER	PCS. IN OUTER
MFNR5012075	3"	76	30	4.5	0.014	25	100

FINISH AVAILABLE - BZP

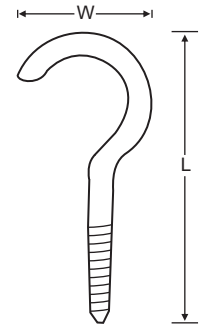

GPL0401 : PLASTIC SCREW CUP & CAP



TECHNICAL DATA

ITEM CODE	BASE DIA D1	CAP DIA D2	WT/PCS	PCS. IN INNER	PCS. IN OUTER	PCS. IN PALLET
PMIH0401XXX	12.0	11.0	0.0003	1000	5000	225000

COLOUR AVAILABLE : WHITE, BROWN, BLACK, MAGNOLIA, GREY

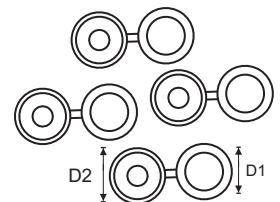

GPL0051 : PLASTIC CONNECTING BOLT



TECHNICAL DATA

ITEM CODE	LENGTH	DIAMETER	BOLT	WT/PCS	PCS. IN INNER	PCS. IN OUTER
PMIH0051040	47	16	M6	0.002	1000	5000

COLOUR AVAILABLE : WHITE, BROWN, BLACK, MAGNOLIA, GREY

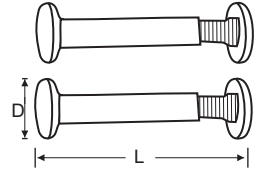

GPL0201 : PLASTIC SHELF BRACKET WITH NAILS



TECHNICAL DATA

ITEM CODE	LENGTH	WIDTH	WIRE DIA	WT/PCS	PCS. IN INNER	PCS. IN OUTER
PMIH0201XXX	15	13	6.5	0.0004	1000	5000

COLOUR AVAILABLE : WHITE, BROWN, BLACK, MAGNOLIA, GREY

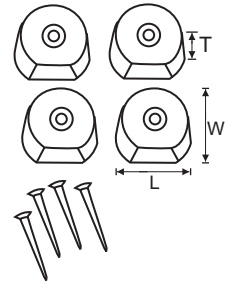

GPL0301 : PLASTIC KD BLOCKS



TECHNICAL DATA

ITEM CODE	LENGTH	WIDTH	THICKNESS	SCREW NO.	WT/PCS	PCS. IN INNER	PCS. IN OUTER
PMIH0301XXX	35	25	12.5	6	0.008	100	1000

COLOUR AVAILABLE : WHITE, BROWN, BLACK, MAGNOLIA, GREY

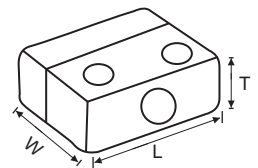

GPL0321 : PLASTIC MODESTY BLOCKS



TECHNICAL DATA

ITEM CODE	LENGTH	WIDTH	THICKNESS	SCREW NO.	WT/PCS	PCS. IN INNER	PCS. IN OUTER
PMIH0321XXX	35	13.5	13	6	0.004	100	1000

COLOUR AVAILABLE : WHITE, BROWN, BLACK, MAGNOLIA, GREY

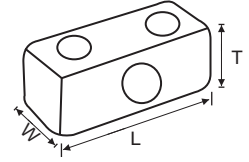

GPL0061: PLASTIC GLASS CLIP



TECHNICAL DATA

ITEM CODE	LENGTH	WIDTH	THICKNESS	WT/PCS	PCS. IN INNER	PCS. IN OUTER
PMIH0061XXX	46	15	3.0	0.002	1000	5000

COLOUR AVAILABLE : BLACK, BROWN

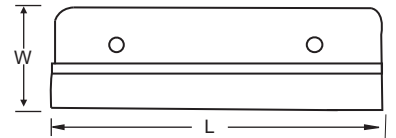

GPV001 : UPVC LEVER HANDLE



TECHNICAL DATA

ITEM CODE	LENGTH	WIDTH	CENTRE DISTANCE	BOLT	WT/PAIR	SET. IN INNER	SET. IN OUTER
HHNDPV01XXX	203	25	91	M5	0.616	1	30

FINISH AVAILABLE : ELECTO BRASS PLATED,
SATIN NICKEL PLATED , EPOXY WHITE

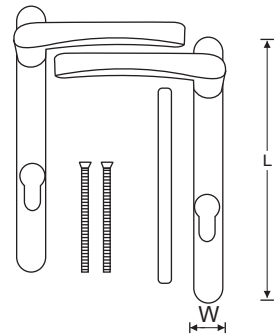

GWD0050 : PINE KNOB



TECHNICAL DATA

ITEM CODE	HEIGHT	DIAMETER	BOLT	WT/SET	SET. IN INNER	SET. IN OUTER
WMIH0050032	25	30	M4	0.011	20	200
WMIH0050038	34	38	M4	0.013	20	200

COLOUR AVAILABLE : PINE PLAIN UNLACQUERED

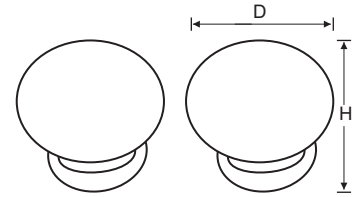

SHELF BRACKET STAYED



TECHNICAL DATA

DPG CODE	ITEM CODE	SIZE	LENGTH	WIDTH	THICKNESS	SCREW NO.	WT/PCS	PCS. IN INNER	PCS. IN OUTER
D608	MMIHD608300	12"X14"	305X356	20	5	8	0.766	6	12
D610	MMIHD610350	14"X16"	356X406	20	5	8	0.905	6	12
D612	MMIHD612400	16"X18"	406X457	20	5	8	1.040	6	12

FINISH AVAILABLE : EXB, EXW, GREY

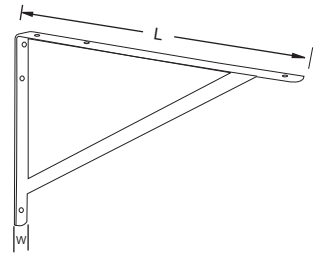

ORNAMENTAL SELF BRACKET



TECHNICAL DATA

DPG CODE	ITEM CODE	SIZE	LENGTH	WIDTH	THICKNESS	SCREW NO.	WT/PCS	PCS. IN INNER	PCS. IN OUTER
D404	MMIHD404100	4"X4"	110X110	12	2.5	6	0.124	10	50
D406	MMIHD406150	6"X6"	152X152	12	2.5	6	0.165	10	10
D408	MMIHD408200	8"X8"	203X203	12	2.5	6	0.205	10	10
D410	MMIHD410250	10"X10"	254X254	12	2.5	6	0.254	10	10

FINISH AVAILABLE : EXB, EXW, GREY

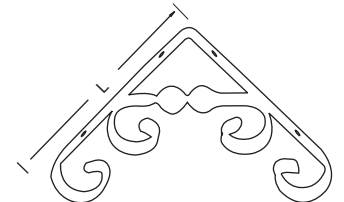



GPL0101 : PLASTIC RIM MORTICE KNOB FURNITURE



TECHNICAL DATA

ITEM CODE	HEIGHT	BASE DIA	KNOB DIA	SCREW NO.	WT/SET	SET. IN INNER	SET. IN OUTER
HNIN0101XXX	53	57	51	6	0.095	10	100

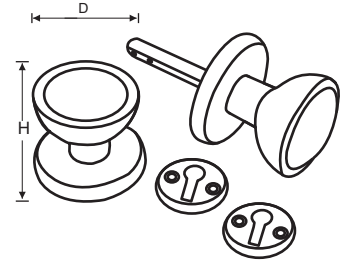

COLOUR AVAILABLE : PINE PLAIN UNLACQUERED

Note

1. _____
2. _____
3. _____
4. _____
5. _____
6. _____
7. _____
8. _____
9. _____
10. _____
11. _____
12. _____
13. _____
14. _____



Secondary Security



Note

1. _____
2. _____
3. _____
4. _____
5. _____
6. _____
7. _____
8. _____
9. _____
10. _____
11. _____
12. _____
13. _____
14. _____
15. _____
16. _____
17. _____
18. _____
19. _____
20. _____



ADSZ0001 ZINC DIE CAST SECURITY BOLT (DOOR GUARD)



TECHNICAL DATA

ITEM CODE	LENGTH	WIDTH	THICKNESS	SCREW NO.	WT/PCS	PCS. IN INNER	PCS. IN OUTER
ZADS0001XXX	116	59	2.4	5	0.100	5	30

FINISH AVAILABLE - CP, NP, EB

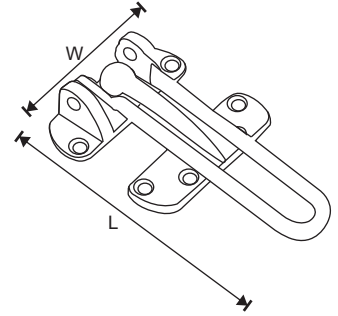

6301 MILD STEEL SECURITY DOOR CHAIN



TECHNICAL DATA

ITEM CODE	LENGTH	WIDTH	THICKNESS	SCREW NO.	WT/PCS	PCS. IN INNER	PCS. IN OUTER
MSCF6301100	90	35	2.0	6	0.118	10	100

FINISH AVAILABLE - BZP, NP, EB, CP

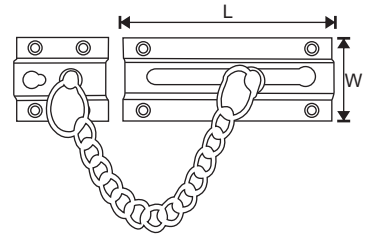

6300 MILD STEEL SECURITY DOOR CHAIN



TECHNICAL DATA

ITEM CODE	LENGTH	WIDTH	THICKNESS	SCREW NO.	WT/PCS	PCS. IN INNER	PCS. IN OUTER
MSCF6300100	85	34	1.9	6	0.123	10	100

FINISH AVAILABLE - BZP, NP, EB, CP

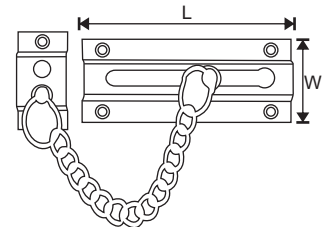



ADSM009

MILD STEEL DOOR CHAIN



TECHNICAL DATA

ITEM CODE	LENGTH	WIDTH	THICKNESS	SCREW NO.	WT/PCS	PCS. IN INNER	PCS. IN OUTER
MADS0009040	44	38	3.0	6	0.135	10	100

FINISH AVAILABLE - BZP, NP, EB, CP

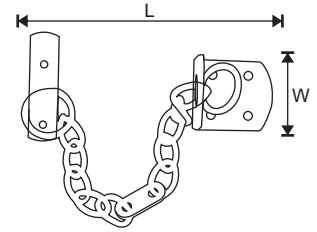

BRASS DOOR CHAIN



TECHNICAL DATA

DPG CODE	ITEM CODE	LENGTH	WIDTH	THICKNESS	SCREW NO.	WT/PCS	PCS. IN INNER	PCS. IN OUTER
GB6300	BSCF6300085	85	35	2.2	4	0.117	10	100

FINISH AVAILABLE - POLISHED & LACQUERED BRASS, CP, SNP

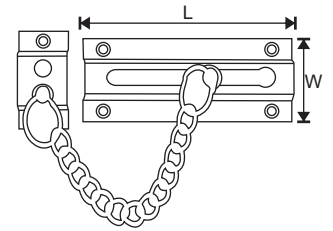

BLACK ANTIQUE SECURITY LATCH (DOOR CHAIN)



TECHNICAL DATA

DPG CODE	ITEM CODE	LENGTH	WIDTH	SCREW NO.	WT/PCS	PCS. IN INNER	PCS. IN OUTER
G0802	CIRN0802133	125	78	4	0.278	5	60

FINISH AVAILABLE : EXB, DUROSIL

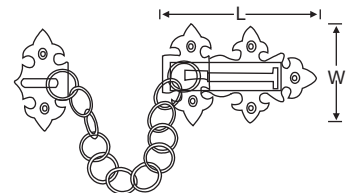

70010 HINGE BOLT



TECHNICAL DATA

ITEM CODE	SIZE	LENGTH	DIA	PLATE L1XW	SCREW NO.	WT/PCS	PCS. IN INNER	PCS. IN OUTER
MIRN7001XXX	2"	78	12.5	51X29	6	0.057	10	200

FINISH AVAILABLE : BZP, NP, EB

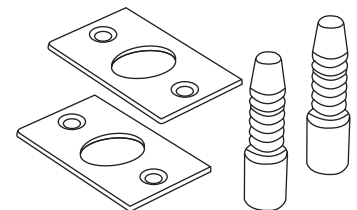



Signages & Numerals



Note

1. _____
2. _____
3. _____
4. _____
5. _____
6. _____
7. _____
8. _____
9. _____
10. _____
11. _____
12. _____
13. _____
14. _____
15. _____
16. _____
17. _____
18. _____
19. _____
20. _____



SIGNAGES & PICTOGRAM (ROUND & RECTANGULAR)



**MALE
ADSS0020**



**DISABLE
ADSS0019**



**FEMALE
ADSS0021**



**FIRE DOOR
KEEP CLEAR
ADSS0029**



**UNISEX
ADSS0017**



**FIRE DOOR
KEEP LOCKED
ADSS0025**

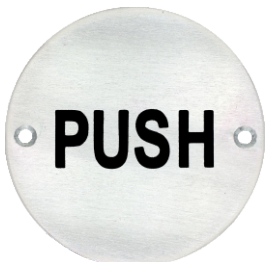

**PUSH
ADSS0024**



**FIRE DOOR
KEEP SHUT
ADSS0022**

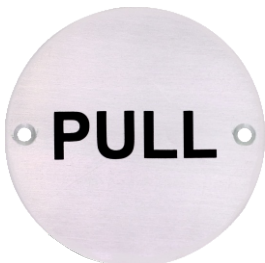

**PULL
ADSS0023**



**AUTOMATIC FIRE
DOOR KEEP
CLEAR
ADSS0028**

AVAILABLE IN SS AND ALUMINIUM



BRASS SYMBOLS



TECHNICAL DATA

NAME	DPG CODE	ITEM CODE	LENGTH	WIDTH	THICKNESS	SCREW NO.	WT/PCS	PCS. IN INNER	PCS. IN OUTER
MALE	GB1700	BMIH1700150	152	101	1.0	4	0.128	20	100
FEMALE	GB1701	BMIH1701150	152	101	1.0	4	0.128	20	100
DISABLED	GB1702	BMIH1702150	152	101	1.0	4	0.128	20	100

FINISH AVAILABLE - POLISHED & LACQUERED BRASS/CP/SNP

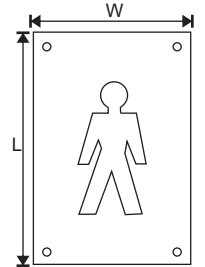

ALUMINIUM SYMBOLS - SELF ADHESIVE



TECHNICAL DATA

NAME	DPG CODE	ITEM CODE	LENGTH	WIDTH	THICKNESS	WT/PCS	PCS. IN INNER	PCS. IN OUTER
MALE	GA1700	AMIH1700150	152	100	1.25	0.048	10	200
FEMALE	GA1701	AMIH1701150	152	100	1.25	0.048	10	200
DISABLED	GA1702	AMIH1702150	152	100	1.25	0.048	10	200

Finish Available : SAA, PAA

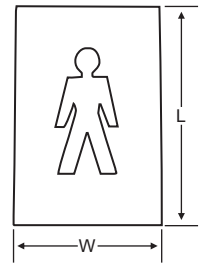

ALUMINIUM PUSH & PULL PLATES - SELF ADHESIVE

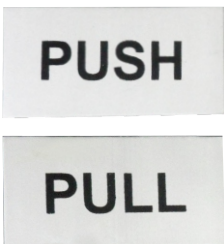

TECHNICAL DATA

NAME	DPG CODE	ITEM CODE	LENGTH	WIDTH	THICKNESS	WT/PCS	PCS. IN INNER	PCS. IN OUTER
PUSH	GA1710	AMIH1710075	75	38	1.0	0.008	50	500
PULL	GA1711	AMIH1711075	75	38	1.0	0.008	50	500

Finish Available : SAA, PAA

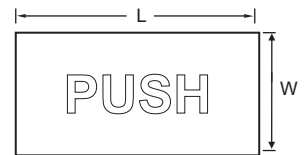



G0210 TO G0219 : BLACK ANTIQUE NUMERAL SOLID 2"



G0210



G0211



G0212



G0213

G0210A TO G0219A : BLACK ANTIQUE NUMERAL SOLID 4"



G0214A



G0216A



G0217A



G0218A

G0600 TO G0609 : BLACK ANTIQUE NUMERAL HOLLOW 3"



G0602



G0603



G0607



G0609

G0650 TO G0653: BLACK ANTIQUE HOLLOW ALPHABET 3"



G0650



G0651



G0652



G0653



VICTORIAN BRASS NUMERALS 2" (HOLLOW) GB0680 TO GB0689



GB 0685



GB 0680



GB 0687

VICTORIAN BRASS NUMERALS 3" (HOLLOW) GB0700 TO GB0709



GB 0703



GB 0704



GB 0706

VICTORIAN BRASS NUMERALS 3" (SOLID) 0 TO 9 (GB0700 TO GB0709)



GB0700



GB0701



GB0702



GB0703

Also available in 2.5" (Solid) - GB (700A) TO GB (709A)

BRASS ALPHABETS 2" & 3" A TO Z GB0751 TO GB0776



GB0751



GB0752



GB0753



Wardrobe Tubes & Brackets



Note

1. _____
2. _____
3. _____
4. _____
5. _____
6. _____
7. _____
8. _____
9. _____
10. _____
11. _____
12. _____
13. _____
14. _____
15. _____
16. _____
17. _____
18. _____
19. _____
20. _____



MILD STEEL TUBES & RAIL



AVAILABLE IN VARIOUS PROFILES & SHAPES

ROUND, OVAL

Outer Diameters : 1mm to 127mm
Wall Thickness : 0.10mm to 4mm



Also Available :- Oval, End Brackets & Accessories in various finishes.
CP, Satin, Antique Brass etc

1105 : ZINC DIE CAST WARDROBE END BRACKET



TECHNICAL DATA

ITEM CODE	HEIGHT	BASE DIA.	OUTER DIA.	INNER DIA.	SCREW NO.	WT/ PCS	PCS. IN INNER	PCS. IN OUTER	PCS. IN PALLET
ZMIH1105019	79	46	25	20	7	0.066	20	200	8000
ZMIH1105025	89	46	31	26	7	0.078	20	200	8000

FINISH AVAILABLE : BRASS, CHROME

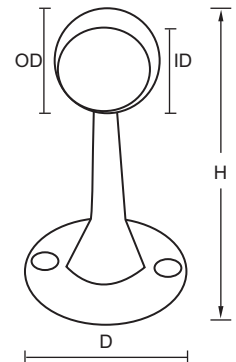

1101 : ZINC DIE CAST WARDROBE CENTRE BRACKET



TECHNICAL DATA

ITEM CODE	HEIGHT	BASE DIA.	OUTER DIA.	INNER DIA.	SCREW NO.	WT/ PCS	PCS. IN INNER	PCS. IN OUTER	PCS. IN PALLET
ZMIH1101019	79	46	25	20	7	0.056	20	200	8000
ZMIH1101025	89	46	31	26	7	0.059	20	200	8000

FINISH AVAILABLE : BRASS, CHROME

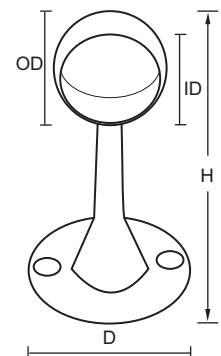



1111 : ZINC DIE CAST WARDROBE END SOCKET



TECHNICAL DATA

ITEM CODE	BASE DIA.	OUTER DIA.	INNER DIA.	SCREW NO.	WT/PCS	PCS. IN INNER	PCS. IN OUTER
ZMIH1111025	45	29	26	7	0.019	50	500
ZMIH1111019	50	23	20	7	0.017	50	500

FINISH AVAILABLE : BRASS, CHROME

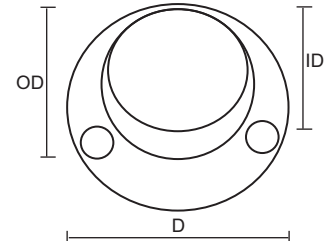

1116 : ZINC DIE CAST OVAL CENTRE SOCKET



TECHNICAL DATA

ITEM CODE	SIZE	HEIGHT	WIDTH	SCREW NO.	WT/PCS	PCS. IN INNER	PCS. IN OUTER
ZMIH1116019	3/4"	79	45	6	0.045	50	200
ZMIH1116025	1"	81	45	6	0.050	20	200

FINISH AVAILABLE : BRASS, CHROME

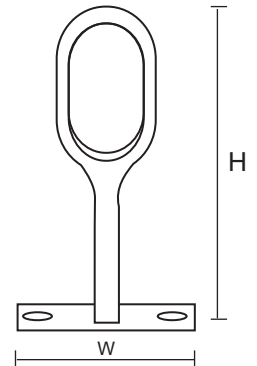

1121 : ZINC DIE CAST OVAL END SOCKET



TECHNICAL DATA

ITEM CODE	SIZE	HEIGHT	WIDTH	SCREW NO.	WT/PCS	PCS. IN INNER	PCS. IN OUTER
ZMIH1121019	3/4"	43	19	6	0.015	20	200
ZMIH1121025	1"	40	15	6	0.020	20	200

FINISH AVAILABLE : BRASS, CHROME

