



WINDOW FASTENERS



GZC2001 : ZINC DIE CAST CASEMENT FASTENER (WEDGE)



TECHNICAL DATA

ITEM CODE	LENGTH	WIDTH	SCREW NO.	WT/PCS	PCS. IN INNER	PCS. IN OUTER
ZMIH2001XXX	102	47	7	0.067	10	100

FINISH AVAILABLE : EB, CP, EXW

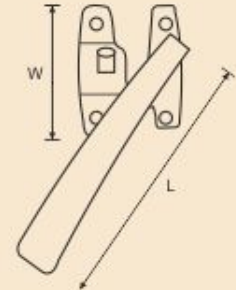

GZC2031 : ZINC DIE CAST LOCKING CASEMENT FASTENER



TECHNICAL DATA

ITEM CODE	LENGTH	WIDTH	SCREW NO.	WT/PCS	PCS. IN INNER	PCS. IN OUTER
ZMIH2031XXX	126	62	7	0.155	10	100

FINISH AVAILABLE : EB, EPOXY SILVER, EXW, EXBR, SNP, CP

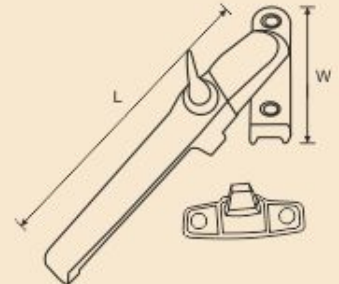

GZC2032 : ZINC DIE CAST CASEMENT FASTENER



TECHNICAL DATA

ITEM CODE	LENGTH	WIDTH	SCREW NO.	WT/PCS	PCS. IN INNER	PCS. IN OUTER
ZMIH2032XXX	126	62	7	0.155	10	100

FINISH AVAILABLE : EB, EPOXY SILVER, EXW, EXBR, SNP, CP

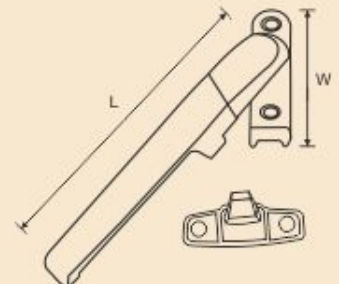



GZC2005 : ZINC DIE CAST WINDOW FASTENER



TECHNICAL DATA

ITEM CODE	LENGTH	WIDTH	SCREW NO.	WT./PCS	PCS. IN INNER	PCS. IN OUTER
ZMIH2005XXX	62	45	7	0.065	20	200

FINISH AVAILABLE : EB, CP

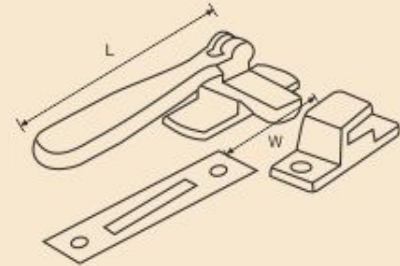

GZC3035 : ZINC DIE CAST FITCH FASTENER



TECHNICAL DATA

ITEM CODE	LENGTH	WIDTH	WT./PCS	PCS. IN INNER	PCS. IN OUTER
ZMIH3035XXX	65	6	0.059	20	200

FINISH AVAILABLE : EB, BZP

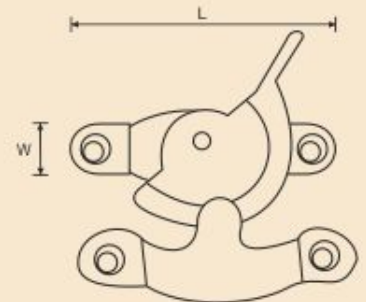

GZC2071 : ZINC DIE CAST SASH FASTENER



TECHNICAL DATA

ITEM CODE	LENGTH	WIDTH	SCREW NO.	WT./PCS	PCS. IN INNER	PCS. IN OUTER
ZMIH2071XXX	62	45	7	0.065	20	200

FINISH AVAILABLE : EB, BZP, CP

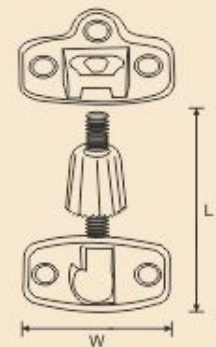



GB3015 BRASS VICTORIAN CASEMENT FASTENER LOCKING



TECHNICAL DATA

DPG CODE	ITEM CODE	LENGTH	WIDTH	SCREW NO.	WT/PCS	PCS. IN INNER	PCS. IN OUTER
GB3015	BMIH3015XXX	116	19	6	0.150	10	120

FINISH AVAILABLE : POLISHED & LACQUERED BRASS, CP, SNP

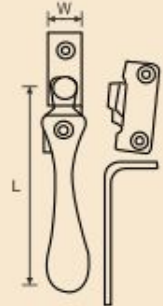

GB3020 BRASS VICTORIAN HEAVY CASEMENT FASTENER WEDGE



TECHNICAL DATA

DPG CODE	ITEM CODE	LENGTH	WIDTH	SCREW NO.	WT/PCS	PCS. IN INNER	PCS. IN OUTER
GB3020	BMIH3020XXX	106	63	6	0.198	10	80

FINISH AVAILABLE - POLISHED & LACQUERED BRASS, CP, SNP

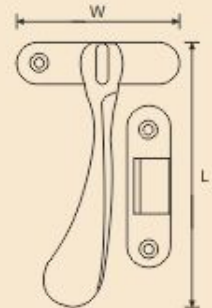

GB3025 BRASS VICTORIAN CASEMENT FASTENER HOOK & MORTICE



TECHNICAL DATA

DPG CODE	ITEM CODE	LENGTH	WIDTH	SCREW NO.	WT/PCS	PCS. IN INNER	PCS. IN OUTER
GB3025	BMIH3025057	102	53	6	0.149	10	100

FINISH AVAILABLE - POLISHED & LACQUERED BRASS, CP, SNP





GB3030 BRASS VICTORIAN CASEMENT FASTENER WEDGE



TECHNICAL DATA

DPG CODE	ITEM CODE	LENGTH	WIDTH	SCREW NO.	WT/PCS	PCS. IN INNER	PCS. IN OUTER
GB3030	BMIH3030XXX	116	19	6	0.142	10	120

FINISH AVAILABLE - POLISHED & LACQUERED BRASS, CP, SNP



GB3032 BRASS NIGHT VENT FASTENER WEDGE



TECHNICAL DATA

DPG CODE	ITEM CODE	LENGTH	WIDTH	SCREW NO.	WT/PCS	PCS. IN INNER	PCS. IN OUTER
GB3032	BMIH3032XXX	110	50	6	0.110	10	100

FINISH AVAILABLE - POLISHED & LACQUERED BRASS, CP, SNP

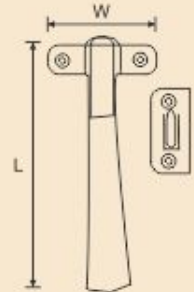

GB3001 VICTORIAN QUADRANT SASH FASTENER



TECHNICAL DATA

DPG CODE	ITEM CODE	LENGTH	WIDTH	SCREW NO.	WT/PCS	PCS. IN INNER	PCS. IN OUTER
GB3001	BMIH3001064	66	18	6	0.132	10	100

FINISH AVAILABLE - POLISHED & LACQUERED BRASS, CP, SNP

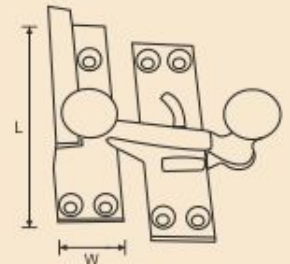



GB3005 BRASS VICTORIAN BEEHIVE SASH FASTENER



TECHNICAL DATA

DPG CODE	ITEM CODE	LENGTH	WIDTH	SCREW NO.	WT/PCS	PCS. IN INNER	PCS. IN OUTER
GB3005	BMIH3005065	69	20	6	0.144	10	100

FINISH AVAILABLE - POLISHED & LACQUERED BRASS, CP, SNP

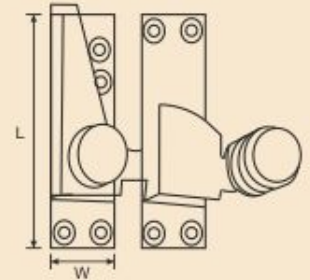

GB3035A BRASS FITCH FASTENER C/W KEEP (LOCKING)



TECHNICAL DATA

DPG CODE	ITEM CODE	LENGTH	WIDTH	SCREW NO.	WT/PCS	PCS. IN INNER	PCS. IN OUTER
GB3035A	BMIH3036XXX	62	15	7	0.090	10	160

FINISH AVAILABLE - POLISHED & LACQUERED BRASS, CP, SNP

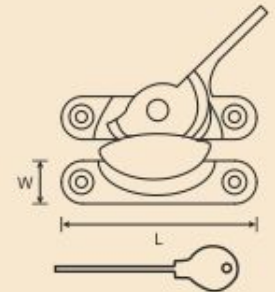

GB3035 BRASS VICTORIAN FITCH FASTENER



TECHNICAL DATA

DPG CODE	ITEM CODE	LENGTH	WIDTH	SCREW NO.	WT/PCS	PCS. IN INNER	PCS. IN OUTER
GB3035	BMIH3035XXX	62	15	7	0.090	10	160

FINISH AVAILABLE - POLISHED & LACQUERED BRASS, CP, SNP

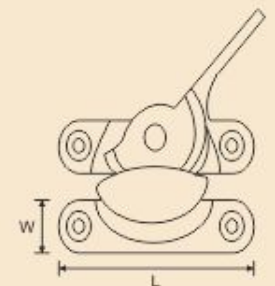



GB3010 BRASS VICTORIAN BRIGHTON FASTENER SPRUNG



TECHNICAL DATA

DPG CODE	ITEM CODE	LENGTH	WIDTH	SCREW NO.	WT/PCS	PCS. IN INNER	PCS. IN OUTER
GB3010	BMIH3010XXX	58	23	6	0.155	10	100

FINISH AVAILABLE - POLISHED & LACQUERED BRASS, CP, SNP

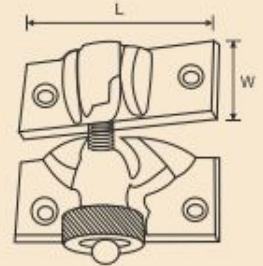

GB3055 BRASS BALL & CLAW TYPE C/W KEEP (NON LOCKING)



TECHNICAL DATA

DPG CODE	ITEM CODE	LENGTH	WIDTH	SCREW NO.	WT/PCS	PCS. IN INNER	PCS. IN OUTER
GB3055	BMIH3055XXX	64	19	6	0.124	10	120

FINISH AVAILABLE - POLISHED & LACQUERED BRASS, CP, SNP

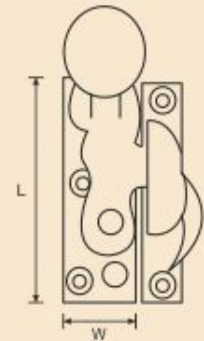

GB3055A BRASS BALL & CLAW TYPE C/W KEEP (LOCKING)



TECHNICAL DATA

DPG CODE	ITEM CODE	LENGTH	WIDTH	SCREW NO.	WT/PCS	PCS. IN INNER	PCS. IN OUTER
GB3055A	BMIH3055XXX	64	19	6	0.133	10	120

FINISH AVAILABLE - POLISHED & LACQUERED BRASS, CP, SNP

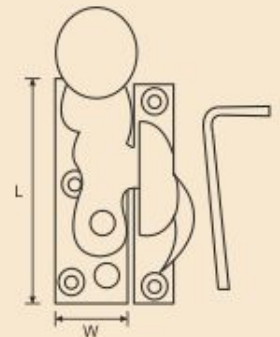

GB3050 BRASS SHOWCASE FASTENER



TECHNICAL DATA

DPG CODE	ITEM CODE	LENGTH	WIDTH	SCREW NO.	WT/PCS	PCS. IN INNER	PCS. IN OUTER
GB3050	BMIH3050XXX	40	11	6	0.035	20	500

FINISH AVAILABLE - POLISHED & LACQUERED BRASS, CP, SNP

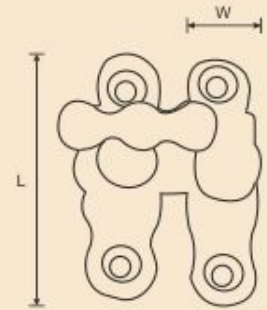

GB0851 BRASS VICTORIAN SASH LIFT



TECHNICAL DATA

DPG CODE	ITEM CODE	HEIGHT	WIDTH	THICKNESS	SCREW NO.	WT/PCS	PCS. IN INNER	PCS. IN OUTER
GB0851	BMIH0851050	51	51	2.0	6	0.045	20	240

FINISH AVAILABLE - POLISHED & LACQUERED BRASS, CP, SNP

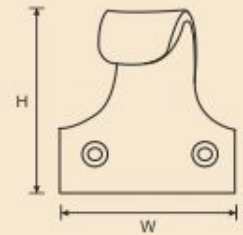

GA1851 ALUMINIUM SASH LIFT



TECHNICAL DATA

DPG CODE	ITEM CODE	HEIGHT	WIDTH	THICKNESS	SCREW NO.	WT/PCS	PCS. IN INNER	PCS. IN OUTER
GA1851	AMIH1851050	51	43	1.4	6	0.008	20	500

FINISH AVAILABLE : SAA, PAA
SIZE AVAILABLE : HEAVY (GA1852)

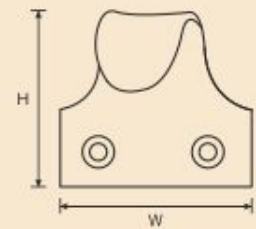

GB3550 BRASS WEEKES CATCH



TECHNICAL DATA

DPG CODE	ITEM CODE	LENGTH	WIDTH	THICKNESS	SCREW NO.	WT/PCS	PCS. IN INNER	PCS. IN OUTER
GB3550	BMIH3150XXX	70	17	5.0	6	0.060	20	240

FINISH AVAILABLE - POLISHED & LACQUERED BRASS, CP, SNP

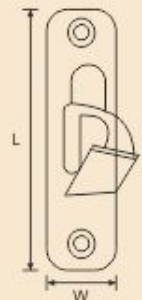

BRASS GEORGIAN CASEMENT FASTENER H/M



GB1072

BRASS GEORGIAN CASEMENT FASTENER WEDGE



GB1074

GA1561 ALUMINIUM CASEMENT FASTENER



TECHNICAL DATA

DPG CODE	ITEM CODE	LENGTH	WIDTH	SCREW NO.	WT/PCS	PCS. IN INNER	PCS. IN OUTER
GA1561	AMIH1561XXX	100	54	6	0.043	10	250

FINISH AVAILABLE : SAA, PAA

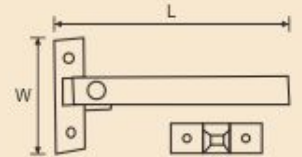

G0380 BLACK ANTIQUE SOLID CASEMENT FASTENER, HOOK & MORTICE PLATE



TECHNICAL DATA

DPG CODE	ITEM CODE	LENGTH	WIDTH	SCREW NO.	WT/SET	SET. IN INNER	SET. IN OUTER
G0380	CIRN0380093	93	59	7	0.308	5	60

FINISH AVAILABLE : EXB, DUROSIL

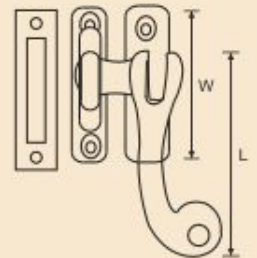

G0415 BLACK ANTIQUE CURLY TAIL CASEMENT FASTENER, HOOK & MORTICE PLATE



TECHNICAL DATA

DPG CODE	ITEM CODE	LENGTH	WIDTH	SCREW NO.	WT/SET	SET. IN INNER	SET. IN OUTER
G0415	CMIH0415085	95	62	7	0.216	5	80

FINISH AVAILABLE : EXB, DUROSIL





Note

Handwriting practice area with 20 horizontal dotted lines.



HINGES

3D ADJUSTABLE INVISIBLE HINGES



TECHNICAL DATA

DPG CODE	SIZE	LENGTH	WIDTH	SCREW NO.	WT/PAIR	PRS. IN INNER	PRS. IN OUTER	WEIGHT CAPACITY
GZC1215	134X21	134	21	5	0.550	1	10	60 KGS
GZC1216	159X28	159	28	5	1.140	1	10	80 KGS
GZC1217	200X32	200	32	5	1.700	1	10	120 KGS

ALL FINISHES ARE AVAILABLE EXCEPT HSG
 NOTE: ABOVE WEIGHT CAPACITY IS FOR 3PCS OF HINGES
 AND FOR 2 LAKHS CYCLES.

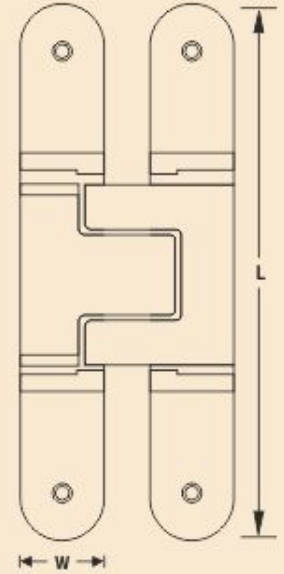

GZC1201 : ZINC DIE CAST CONCEALED HINGE



TECHNICAL DATA

ITEM CODE	SIZE	LENGTH	WIDTH	SCREW NO.	WT/PAIR	PRS. IN INNER	PRS. IN OUTER
ZHIN1201044	44.5X13	44.5	13	5	0.110	5	100
ZHIN1201060	60X13	60	13	5	0.194	5	50
ZHIN1201070	70X16	70	16	5	0.278	5	50
ZHIN1201095	95X19	95	19	6	0.580	5	30
ZHIN1201025	117X25.5	117	25.5	7	1.288	2	10
ZHIN1201116	117X28	117	28	7	1.606	2	10
ZHIN1201137	139X35	139	35	7	2.066	2	10

ALL FINISHES ARE AVAILABLE EXCEPT HSG

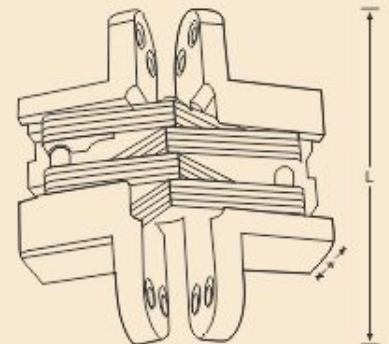

STAINLESS STEEL TWO BALL BEARING HINGES

Certifire Certified **CE 13** BSEN 1935

2812-CPR-AC0067



TECHNICAL DATA

DPG CODE	ITEM CODE	SIZE	LENGTH	WIDTH	THICKNESS	SCREW NO.	WT/ PAIR	PRS. IN INNER	PRS. IN OUTER	PRS. IN PALLET
551SSBB	SHIN1001100	4"X3"	101	76	3.0	10	0.480	1	40	1800
551SSBB	SHIN1002100	4"X3.5"	101	90	3.0	10	0.540	1	40	1360
551SSBB	SHIN1003100	4"X4"	101	101	3.0	10	0.590	1	40	1360
551SSBB	SHIN1004114	4.5"X4"	114	101	3.4	10	0.768	1	20	1020
551SSBB	SHIN1005125	5"X3"	125	76	3.0	10	0.610	1	30	1080
551SSBB	SHIN1006150	6"X3"	150	76	3.0	10	0.780	1	20	1020

FINISH AVAILABLE : MIRROR POLISHED, ELECTRO BRASS, SATIN, BLACK NICKEL
ALSO AVAILABLE IN RADIUS CORNER

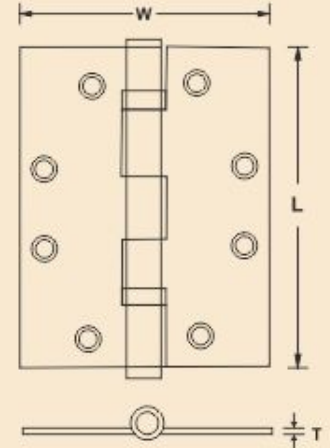

4 7 6 1 1 4 0 13



ANTI CORROSIVE
240 Hrs.

STAINLESS STEEL TWO BALL BEARING HINGES

Certifire Certified **CE 11** BSEN 1935

2812-CPR-AC5104



TECHNICAL DATA

DPG CODE	ITEM CODE	SIZE	LENGTH	WIDTH	THICK.	SCREW NO.	WT/ PAIR	PRS. IN INNER	PRS. IN OUTER	PRS. IN PALLET
451SSBBTP	SHIN4515100	4"X3"	101	76	2.6	10	0.422	1	40	1800
451SSBBTP	SHIN4517100	4"X3"	101	76	3	10	0.480	1	40	1800
451SSBBTP	SHIN4519100	4"X3.5"	101	88	3	10	0.540	1	40	1360
451SSBBTP	SHIN4522100	4"X4"	101	101	3	10	0.590	1	40	1360

FINISH AVAILABLE : MIRROR POLISHED, ELECTRO BRASS, SATIN, BLACK NICKEL
ALSO AVAILABLE IN RADIUS CORNER

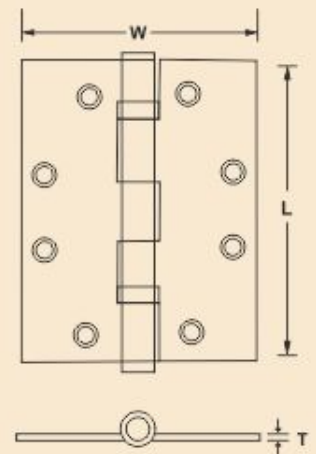

3 7 4 1 1 3 0 11



ANTI CORROSIVE
240 Hrs.

STAINLESS STEEL TWO BALL BEARING HINGES

Certifire Certified **CE7** BSEN 1935

2812-CPR-AC5058

TECHNICAL DATA

DPG CODE	ITEM CODE	SIZE	LENGTH	WIDTH	THICKNESS	SCREW NO.	WT/ PAIR	PRS. IN INNER	PRS. IN OUTER	PRS. IN PALLET
451SSBTP	SHIN4510075	3"x4"	76	101	2	8	0.320	1	50	3000
451BBTP	SHIN4511075	3"x2"	76	50	2	8	0.200	1	50	3200
451BBTP	SHIN4512075	3"x2.5"	76	62	2	8	0.230	1	50	3200
451BBTP	SHIN4513075	3"x3"	76	76	2	8	0.260	1	50	3200
451BBTP	SHIN4515100	4"x3"	101	76	2.6	10	0.420	1	40	1800
451BBTP	SHIN4517100	4"x3"	101	76	3	10	0.480	1	40	1800
451BBTP	SHIN4519100	4"x3.5"	101	88	3	10	0.540	1	40	1360
451BBTP	SHIN4522100	4"x4"	101	101	3	10	0.590	1	40	1360
451BBTP	SHIN4523114	4.5"x4"	114	101	3	10	0.700	1	20	1020

FINISH AVAILABLE : MIRROR POLISHED, ELECTRO BRASS, SATIN, BLACK NICKEL
ALSO AVAILABLE IN RADIUS CORNER

2 7 2 1 1 2 0 7



1935:2002

CF 714

CE2812

1121

FIRE TESTED
FD-20/30/
60/90/120
MINUTES

ANTI CORROSIVE
240 Hrs.

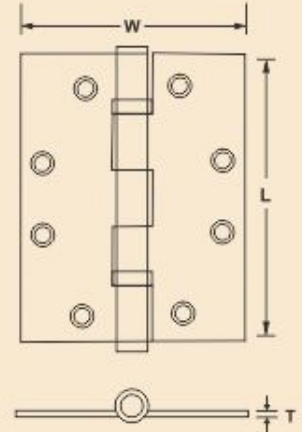

STAINLESS STEEL BUTT HINGE PLAIN JOINT

Certifire Certified **CE7** BSEN 1935

2812-CPR-AC5057

TECHNICAL DATA

DPG CODE	CODE ITEM	SIZE	LENGTH	WIDTH	THICKNESS	SCREW NO.	WT/ PAIR	PRS. IN INNER	PRS. IN OUTER	PRS. IN PALLET
453SS	SHIN0453075	3"	76	49	1.9	8	0.150	10	100	4800
453SS	SHIN0453100	4"	101	71	1.9	8	0.290	5	60	3200
2020SS	SHIN2020090	3.5"	90	49	1.9	8	0.175	10	80	4500
453SST*	SHIN6463100	4"	101	71	1.9	8	0.290	5	60	3200

T* - Templet Hole

FINISH AVAILABLE : MIRROR POLISHED, ELECTRO BRASS, SATIN, BLACK NICKEL
ALSO AVAILABLE IN RADIUS CORNER

2 7 2 1 1 2 0 7



1935:2002

CF 714

CE2812

1121

FIRE TESTED
FD-20/30/
60/90/120
MINUTES

ANTI CORROSIVE
240 Hrs.

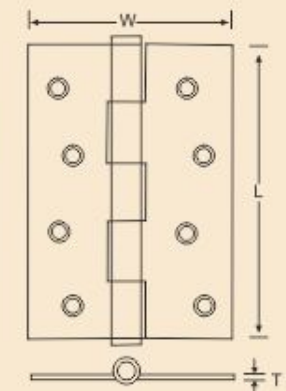

STAINLESS STEEL BUTT HINGE PLAIN JOINT
Certifire Certified CE7 BSEN 1935
2812-CPR-AC5057
TECHNICAL DATA

DPG CODE	ITEM CODE	SIZE	LENGTH	WIDTH	THICKNESS	SCREW NO.	WT/ PAIR	PRS. IN INNER	PRS. IN OUTER	PRS. IN PALLET
451SS	SHIN0451076	3"	76	64	2.35	8	0.270	10	60	3500
451SS	SHIN0451090	3.5"	90	64	2.35	8	0.315	10	60	2400
451SS	SHIN0451100	4"	101	64	2.5	10	0.382	5	40	1800
451SS	SHIN1451100	4"	101	76	2.5	10	0.428	5	40	1800
451SS	SHIN1452100	4"	101	76	2.85	10	0.460	5	40	1800
451SST*	SHIN3451100	4"	101	76	2.5	10	0.428	5	40	1800
451SST*	SHIN5451100	4"	101	76	2.85	10	0.460	5	40	1800
451SST*	SHIN6461100	4"	101	64	2.5	10	0.382	5	40	1800

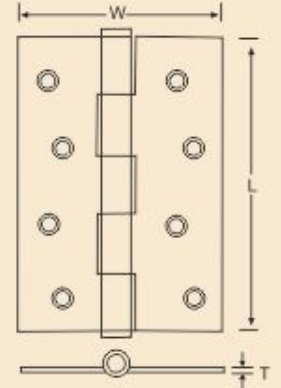

T* - Templet Hole

FINISH AVAILABLE : MIRROR POLISHED, ELECTRO BRASS, SATIN, BLACK NICKEL
ALSO AVAILABLE IN RADIUS CORNER

2	7	2	1	1	2	0	7
---	---	---	---	---	---	---	---



1935:2002



CF 714



CE2812



1121



FIRE TESTED
 FD-20/30/
 60/90/120
 MINUTES

ANTI CORROSIVE
 240 Hrs.

551BB(SSP/DSP) : STAINLESS STEEL BALL BEARING HINGE (SINGLE / DOUBLE SECURITY PINS)

TECHNICAL DATA

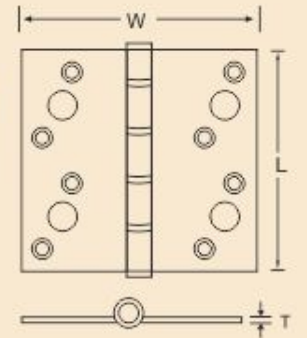
ITEM CODE	SIZE	LENGTH	WIDTH	THICKNESS	SCREW NO.	WT/ PAIR	PRS. IN INNER	PRS. IN OUTER	PRS. IN PALLET
SHIN0556100	4"x4"	100	100	2.6	10	0.540	1	40	1800
SHIN1021100	4"x3"	101	76	3.0	10	0.480	1	40	1360

FINISH AVAILABLE : MIRROR, POLISHED, ELECTRO BRASS, SATIN, BLACK NICKEL

FIRE TESTED
 FD-60 MINUTES

ANTI CORROSIVE
 240 Hrs.

MILD STEEL TWO BALL BEARING HINGES

Certifire Certified **CE 11** BSEN 1935
2812-CPR-AC5104



TECHNICAL DATA

DPG CODE	ITEM CODE	SIZE	LENGTH	WIDTH	THICKNESS	SCREW NO.	WT/ PAIR	PRS. IN INNER	PRS. IN OUTER	PRS. IN PALLET
451BBTP	MHIN4515100	4"X3"	101	76	2.6	10	0.422	1	40	1800
451BBTP	MHIN4517100	4"X3"	101	76	3	10	0.480	1	40	1800
451BBTP	MHIN4519100	4"X3.5"	101	88	3	10	0.540	1	40	1360
451BBTP	MHIN4522100	4"X4"	101	101	3	10	0.590	1	40	1360

FINISH AVAILABLE : SC, BZP, ZYP, EB, EXB, EXW, CP, SNP, SCP,
ANTIQUE BRASS, DUROSIL
ALSO AVAILABLE IN RADIUS CORNER

3 7 4 1 1 3 0 11

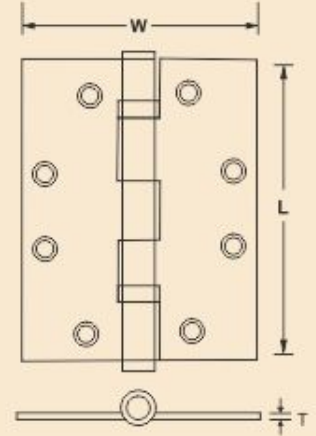

1935:2002

CF 714

CE2812

1121

FIRE TESTED
FD-20/30/
60/90/120
MINUTES

ANTI CORROSIVE
240 Hrs.

MILD STEEL TWO BALL BEARING HINGES

Certifire Certified **CE 7** BSEN 1935
2812-CPR-AC5058



TECHNICAL DATA

DPG CODE	ITEM CODE	SIZE	LENGTH	WIDTH	THICKNESS	SCREW NO.	WT/ PAIR	PRS. IN INNER	PRS. IN OUTER	PRS. IN PALLET
451BBTP	MHIN4510075	3"X4"	76	101	2	8	0.320	1	50	3000
451BBTP	MHIN4511075	3"X2"	76	50	2	8	0.200	1	50	3200
451BBTP	MHIN4512075	3"X2.5"	76	62	2	8	0.230	1	50	3200
451BBTP	MHIN4513075	3"X3"	76	76	2	8	0.260	1	50	3200
451BBTP	MHIN4515100	4"X3"	101	76	2.6	10	0.420	1	40	1800
451BBTP	MHIN4517100	4"X3"	101	76	3	10	0.480	1	40	1800
451BBTP	MHIN4519100	4"X3.5"	101	88	3	10	0.540	1	40	1360
451BBTP	MHIN4522100	4"X4"	101	101	3	10	0.590	1	40	1360
451BBTP	MHIN4523114	4.5"X4"	114	101	3	10	0.700	1	40	1020

FINISH AVAILABLE : SC, BZP, ZYP, EB, EXB, EXW, CP, SNP, SCP,
ANTIQUE BRASS, DUROSIL
ALSO AVAILABLE IN RADIUS CORNER

2 7 2 1 1 2 0 7

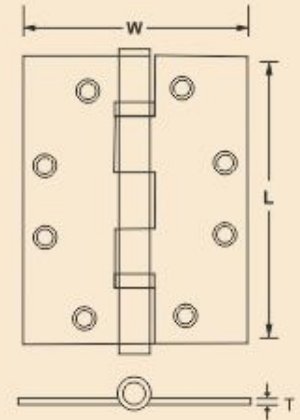

1935:2002

CF 714

CE2812

1121

FIRE TESTED
FD-20/30/
60/90/120
MINUTES

ANTI CORROSIVE
240 Hrs.

MILD STEEL BUTT HINGE PLAIN JOINT

Certifire Certified CE7 BSEN 1935

2812-CPR-AC5057



TECHNICAL DATA

DPG CODE	ITEM CODE	SIZE	LENGTH	WIDTH	THICKNESS	SCREW NO.	WT/ PAIR	PRS. IN INNER	PRS. IN OUTER	PRS. IN PALLET
804	MHIN0804076	3"	76	76	1.9	8	0.240	10	80	3200
2020	MHIN2020076	3"	76	49	1.9	8	0.150	10	100	4800
2020	MHIN2020090	3.5"	90	49	1.9	8	0.175	10	80	4500
2020	MHIN2020100	4"	101	71	1.9	8	0.290	5	60	3200
5050	MHIN5050075	3"	76	46	1.9	8	0.132	10	100	4800
5050	MHIN5050090	3.5"	90	46	1.9	8	0.170	10	80	4500
5050	MHIN5050100	4"	101	58	1.9	8	0.260	5	60	3200

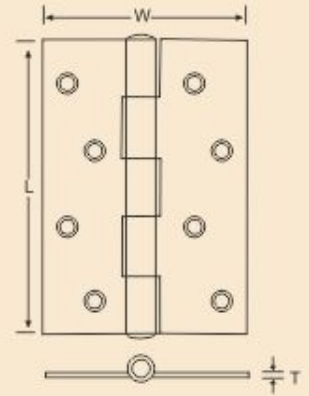

FINISH AVAILABLE : SC, BZP, ZYP, EB, EXB, EXW, CP, SNP, SCP,
ANTIQUE BRASS, DUROSIL
ALSO AVAILABLE IN RADIUS CORNER

2 7 2 1 1 2 0 7



FIRE TESTED
FD-20/30/
60/90/120
MINUTES



ANTI CORROSIVE
240 Hrs.

MILD STEEL BUTT HINGE PLAIN JOINT

Certifire Certified CE7 BSEN 1935

2812-CPR-AC5057



TECHNICAL DATA

DPG CODE	ITEM CODE	SIZE	LENGTH	WIDTH	THICKNESS	SCREW NO.	WT/ PAIR	PRS. IN INNER	PRS. IN OUTER	PRS. IN PALLET
451	MHIN0451075	3"	76	64	2.35	8	0.270	10	60	3500
451	MHIN0451090	3.5"	90	64	2.35	10	0.315	10	60	2400
451	MHIN0451100	4"	101	76	2.5	10	0.428	5	40	1800
451	MHIN451A100	4"	101	76	2.85	10	0.460	5	40	1800
451T*	MHIN451T100	4"	101	76	2.5	10	0.428	5	40	1800
451T*	MHIN5451100	4"	101	76	2.85	10	0.460	5	40	1800

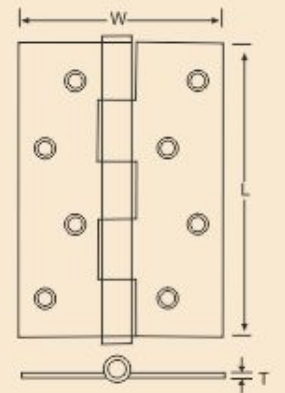

T* - Templet Hole

FINISH AVAILABLE : SC, BZP, ZYP, EB, EXB, EXW, CP, SNP, SCP,
ANTIQUE BRASS, DUROSIL
ALSO AVAILABLE IN RADIUS CORNER

2 7 2 1 1 2 0 7



FIRE TESTED
FD-20/30/
60/90/120
MINUTES



ANTI CORROSIVE
240 Hrs.

STAINLESS STEEL TWO BALL BEARING ANTI LIGATURE HINGE



TECHNICAL DATA

DPG CODE	ITEM CODE	SIZE	LENGTH	WIDTH	THICKNESS	SCREW NO.	WT/ PAIR	PAIR IN INNER	PAIR IN OUTER	PAIR IN PALLET
551BBL	SHIN1016100	4"x3"	101	76	3	10	0.472	1	40	1800

FINISH AVAILABLE : MIRROR POLISHED, ELECTRO BRASS, SATIN, BLACK NICKEL

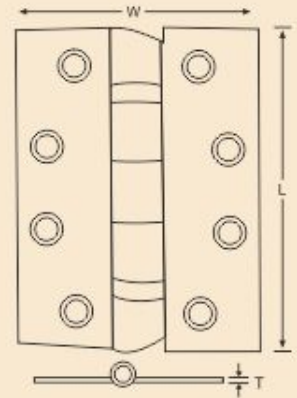

STAINLESS STEEL TWO BALL BEARING HINGE (RADIUS CORNER)



TECHNICAL DATA

DPG CODE	ITEM CODE	SIZE	LENGTH	WIDTH	THICKNESS	SCREW NO.	WT/ PAIR	PRS. IN INNER	PRS. IN OUTER	PRS. IN PALLET
551SSRC	SHIN1158075	3"	76	64	2.50	8	0.268	10	60	3420

FINISH AVAILABLE : MIRROR POLISHED, ELECTRO BRASS, SATIN, BLACK NICKEL

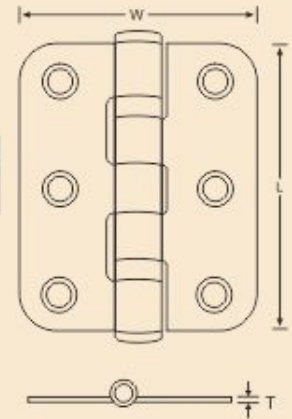

MILD STEEL FOUR BALL BEARING HINGES



TECHNICAL DATA

DPG CODE	ITEM CODE	SIZE	LENGTH	WIDTH	THICKNESS	SCREW NO.	WT /PAIR	PRS. IN INNER	PRS. IN OUTER	PRS. IN PALLET
6520BB	MHIN6520114	4.5"x4.5"	114	114	5.5	12	1.184	1	20	760

FINISH AVAILABLE : SC, BZP, ZYP, EB, EXB, EXW, CP, SNP, SCP, ANTIQUE BRASS, DUROSIL

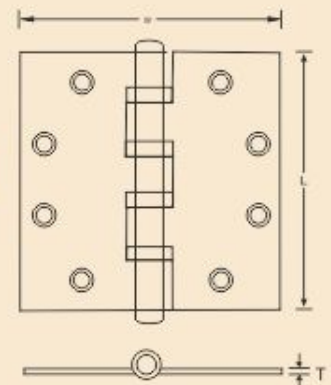

MILD STEEL TWO BALL BEARING HINGES



TECHNICAL DATA

DPG CODE	ITEM CODE	SIZE	LENGTH	WIDTH	THICKNESS	SCREW NO	WT/ PAIR	PRS. IN INNER	PRS. IN OUTER	PRS. IN PALLET
6521BB	MHIN 6521090	3.5"x3.5"	89	89	3.0	10	0.484	1	40	1360
6521BB	MHIN 6521114	4.5"x4.5"	114	114	3.4	12	0.878	1	20	760
6521BB	MHIN 6521125	5"x4.5"	127	114	3.7	12	1.062	1	20	720

FINISH AVAILABLE : SC, BZP, ZYP, EB, EXB, EXW, CP, SNP, SCP,
ANTIQUE BRASS, DUROSIL

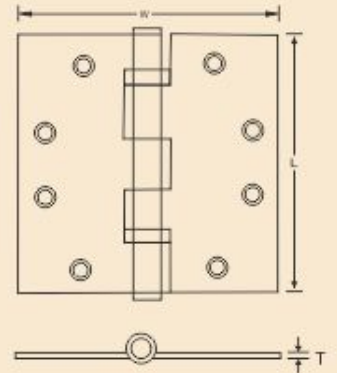

MILD STEEL BUTTON TIP HINGE



TECHNICAL DATA

DPG CODE	ITEM CODE	SIZE	LENGTH	WIDTH	THICKNESS	SCREW NO	WT/ PAIR	PRS. IN INNER	PRS. IN OUTER	PRS. IN PALLET
4521BTP	MHIN4521114	4.5"x4.5"	114	114	3.4	12	0.890	1	20	760

FINISH AVAILABLE : SC, BZP, ZYP, EB, EXB, EXW, CP, SNP, SCP,
ANTIQUE BRASS, DUROSIL

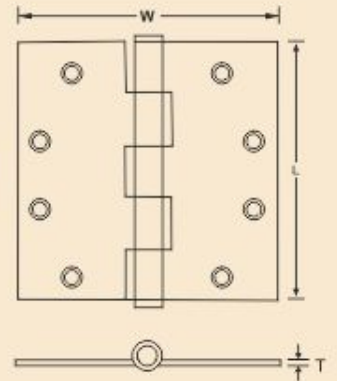

453 : STAINLESS STEEL BUTT HINGE STANDARD CRANKED KNUCKLE, FIXED PIN

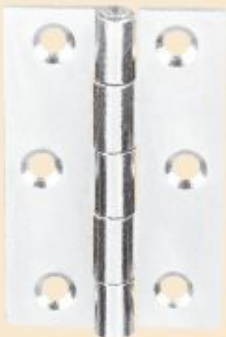

TECHNICAL DATA

ITEM CODE	SIZE	LENGTH	WIDTH	THICKNESS	SCREW NO.	WT/ PAIR	PRS. IN INNER	PRS. IN OUTER	PRS. IN PALLET
SHIN0453075	3"	75	49	1.5	7	0.110	10	200	6800
SHIN0453100	4"	101	71	1.8	8	0.280	5	80	3200

FINISH AVAILABLE : MIRROR, POLISHED, ELECTRO BRASS, SATIN, BLACK NICKEL
ALSO AVAILABLE WITH BUTTON TIP PIN.

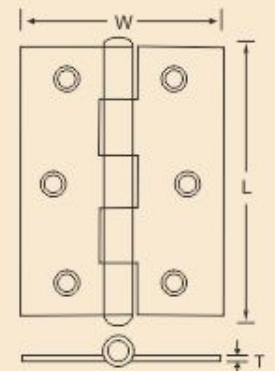

451SS : STAINLESS STEEL STRONG BUTT HINGES CRANKED KNUCKLE, FIXED PIN



TECHNICAL DATA

ITEM CODE	SIZE	LENGTH	WIDTH	THICKNESS	SCREW NO.	WT/ PAIR	PRS. IN INNER	PRS. IN OUTER	PRS. IN PALLET
SHIN0451050	2"	50	42	2.5	8	0.115	10	200	6800
SHIN0451075	3"	76	64	2.5	8	0.270	10	80	3200
SHIN0451100	4"	101	75	2.6	10	0.420	5	50	2400

FINISH AVAILABLE : MIRROR, POLISHED, ELECTRO BRASS, SATIN, BLACK NICKEL
ALSO AVAILABLE IN RADIUS CORNER CODE 451RC,

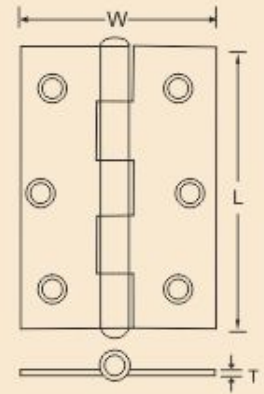

551W : STAINLESS STEEL BUTT HINGE (HEAVY DUTY) CRANKED KNUCKLE DOUBLE WASHERED WITH SPUN OR BUTTON TIP PIN



TECHNICAL DATA

ITEM CODE	SIZE	LENGTH	WIDTH	THICKNESS	SCREW NO.	WT/ PAIR	PRS. IN INNER	PRS. IN OUTER	PRS. IN PALLET
SHIN0563100	4"	101	76	2.6	10	0.416	5	50	2400
SHIN0564100	4"	101	76	2.9	12	0.455	5	50	1800
SHIN0565100	4"	101	90	2.6	10	0.480	5	50	1800
SHIN0566100	4"	101	101	2.6	12	0.530	5	40	1800

FINISH AVAILABLE : MIRROR, POLISHED, ELECTRO BRASS, SATIN, BLACK NICKEL
ALSO AVAILABLE SINGLE WASHER HINGE & BUTTON TIP PIN

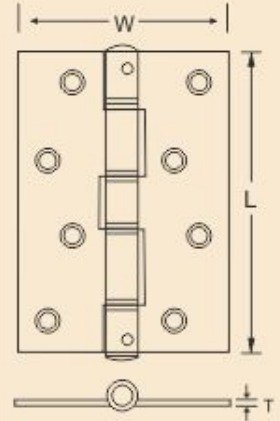

STAINLESS STEEL LOOSE PIN HINGE (RADIUS CORNER)



TECHNICAL DATA

DPG CODE	ITEM CODE	SIZE	LENGTH	WIDTH	THICKNESS	SCREW NO.	WT/ PAIR	PRS. IN INNER	PRS. IN OUTER	PRS. IN PALLET
5904SS	SHIN5904089	3.5"	89	59	2.0	7	0.256	5	50	3200

FINISH AVAILABLE : MIRROR POLISHED, ELECTRO BRASS, SATIN, BLACK NICKEL

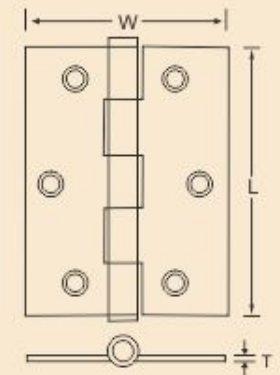

466SS : STAINLESS STEEL RISING BUTT HINGES HANDED CRANKED KNUCKLE, LIFT - OFF PATTERN, FLUSH PIN



TECHNICAL DATA

ITEM CODE	SIZE	LENGTH	WIDTH	THICKNESS	SCREW NO.	WT/ PAIR	PRS. IN INNER	PRS. IN OUTER	PRS. IN PALLET
SHIN0466075	3"	76	70	2.55	8	0.327	5	80	2100
SHIN0466100	4"	100	80	3.0	10	0.570	5	50	1800

FINISH AVAILABLE : MIRROR, POLISHED, ELECTRO BRASS,
SATIN, BLACK NICKEL
AVAILABLE : R/H & L/H

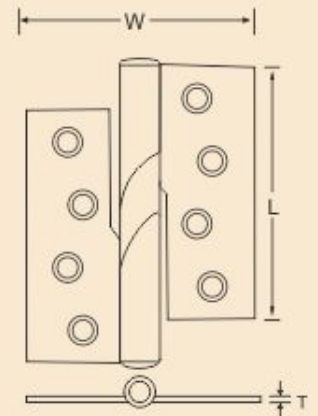

466SS (LBT/RBT) : STAINLESS STEEL RISING BUTT HINGES HANDED CRANKED KNUCKLE, LIFT-OFF PATTERN



TECHNICAL DATA

ITEM CODE	SIZE	LENGTH	WIDTH	THICKNESS	SCREW NO.	WT/ PAIR	PRS. IN INNER	PRS. IN OUTER	PRS. IN PALLET
SHIN467L100	4"	100	75	3.0	10	0.688	1	25	1800

FINISH AVAILABLE : MIRROR, POLISHED, ELECTRO BRASS,
SATIN, BLACK NICKEL
AVAILABLE : R/H & L/H

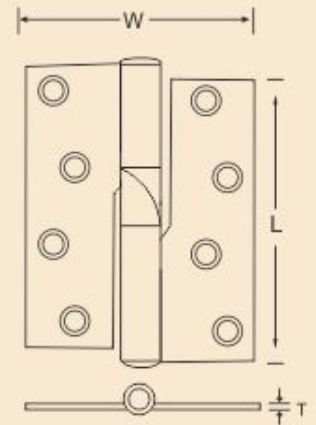

105SSBB : STAINLESS STEEL FLUSH HINGES KNUCKLE, TWO BALL BEARING AND BUTTON TIP PIN



UNCRAKED

CRANKED

TECHNICAL DATA

TYPE	ITEM CODE	SIZE	LENGTH	WIDTH	THICKNESS	SCREW NO.	WT/ PAIR	PRS. IN INNER	PRS. IN OUTER	PRS. IN PALLET
UNCRAKED	SHIN0105100	4"	101	72	2.5	8	0.314	10	60	2700
CRANKED	SHIN0105100	4"	101	76	2.5	8	0.308	10	60	2700

FINISH AVAILABLE : MIRROR, POLISHED, ELECTRO BRASS
SATIN, BLACK NICKEL

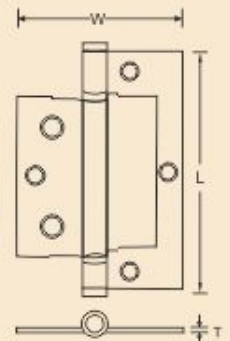

459SS : STAINLESS STEEL SUPPORTING HINGES KNUCKLE, HANDED



TECHNICAL DATA

ITEM CODE	SIZE	LENGTH	WIDTH	THICKNESS	SCREW NO.	WT/ PAIR	PRS. IN INNER	PRS. IN OUTER	PRS. IN PALLET
SHIN459L100	4"	100	86	3.0	10	0.600	5	30	1350

FINISH AVAILABLE : MIRROR, POLISHED, ELECTRO BRASS, SATIN, BLACK NICKEL
AVAILABLE : R/H & L/H

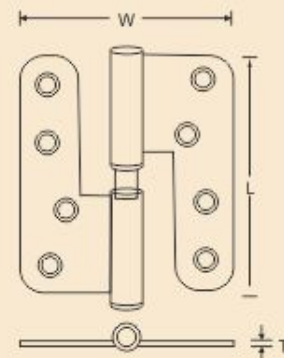

458SSRC : STAINLESS STEEL RADIUS CORNER HINGES HANDED- CRANKED KNUCKLE, LIFT - OFF



TECHNICAL DATA

ITEM CODE	SIZE	LENGTH	WIDTH	THICKNESS	SCREW NO.	WT/ PAIR	PRS. IN INNER	PRS. IN OUTER	PRS. IN PALLET
SHIN0458080	3"	80	80	2.5	7	0.315	5	60	2700

FINISH AVAILABLE : MIRROR, POLISHED, ELECTRO BRASS, SATIN, BLACK NICKEL
AVAILABLE : R/H & L/H

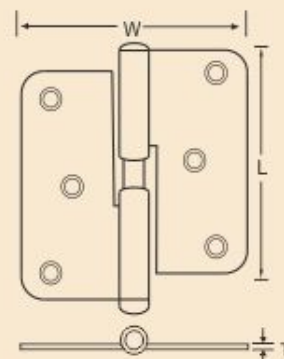

STAINLESS STEEL FLAG HINGE



TECHNICAL DATA

DPG CODE	ITEM CODE	LENGTH	WIDTH	WIDTH W1	THICKNESS	SCREW NO.	WT/ PAIR	PRS. IN INNER	PRS. IN OUTER	PRS. IN PALLET
103SS	SHIN0103095	93	68	40	2.00	5	0.175	10	80	4800

FINISH AVAILABLE : MIRROR, POLISHED, ELECTRO BRASS, SATIN, BLACK NICKEL

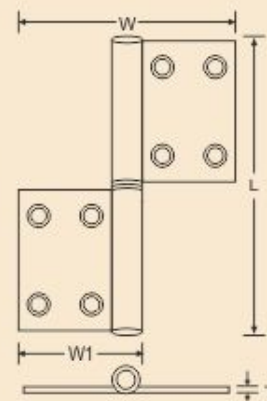

3210SS : STAINLESS STEEL PARLIAMENT HINGE

TECHNICAL DATA



ITEM CODE	SIZE	LENGTH	WIDTH	OPEN WIDTH	THICKNESS	SCREW NO.	WT/ PAIR	PRS. IN INNER	PRS. IN OUTER	PRS. IN PALLET
SHIN3210075	4"x3"	100	76	122	2.5	6	0.546	2	30	1560
SHIN3210100	4"x4"	100	102	158	2.5	10	0.628	2	30	1560
SHIN3210125	4"x5"	100	125	185	2.5	10	0.704	2	20	1040
SHIN3210150	4"x6"	100	150	205	2.5	10	0.770	1	20	1040
SHIN3210200	4"x8"	100	200	270	2.5	10	0.974	1	20	780

FINISH AVAILABLE : MIRROR POLISHED, ELECTRO BRASS,
SATIN, BLACK NICKEL

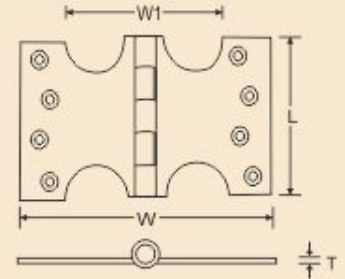

STAINLESS STEEL BUTT HINGES



TECHNICAL DATA

DPG CODE	ITEM CODE	SIZE	LENGTH	WIDTH	THICKNESS	SCREW NO	WT/ PAIR	PRS. IN INNER	PRS. IN OUTER	PRS. IN PALLET
3903SS	SHIN3903089	3.5"	89	89	2.20	8	0.338	10	50	2250
3904SS	SHIN3904100	4"	101	101	2.50	8	0.490	5	40	1440

FINISH AVAILABLE : MIRROR POLISHED, ELECTED BRASS, SATIN, BLACK NICKEL

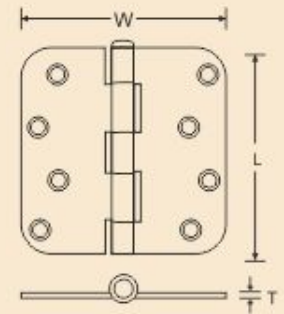

1838 : MILD STEEL BUTT HINGES CRANKED KNUCKLE, FIXED PIN

TECHNICAL DATA

ITEM CODE	SIZE	LENGTH	WIDTH	THICKNESS	N.H.	SCREW NO.	WT/PAIR	PRS. IN INNER	PRS. IN OUTER	PRS. IN PALLET
MHIN1838025	1"	25	25	1.2	4	4	0.016	25	1400	63000
MHIN1838040	1.5"	40	33	1.3	4	4	0.035	10	600	21600
MHIN1838050	2"	50	36	1.4	4	6	0.052	10	400	16800
MHIN1838065	2.5"	65	44	1.4	6	6	0.082	10	250	10000
MHIN1838075	3"	75	49	1.4	6	7	0.111	10	200	9000
MHIN1838090	3.5"	90	56	1.75	6	8	0.190	10	100	4000
MHIN1838100	4"	100	71	1.75	8	8	0.260	5	80	3200
MHIN1838150	6"	150	98	2.15	8	10	0.740	5	30	1200

FINISH AVAILABLE : SC, BZP, ZYP, EB, EXB, EXW, CP, SNP, SCP, PCP
ANTIQUE BRASS, DUROSIL

ALSO AVAILABLE IN RADIUS CORNER, CODE 1838RC

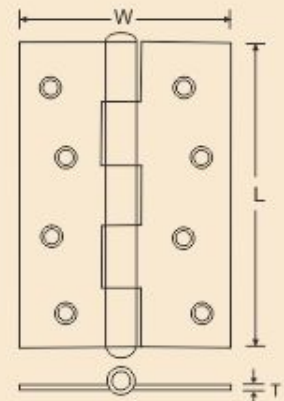

1840 : MILD STEEL BUTT HINGES CRANKED KNUCKLE, REMOVABLE PIN



ITEM CODE	SIZE	LENGTH	WIDTH	THICKNESS	SCREW NO.	WT/PAIR	PRS. IN INNER	PRS. IN OUTER	PRS. IN PALLET
MHIN1840050	2"	50	36	1.4	6	0.056	10	400	16800
MHIN1840065	2.5"	65	44	1.4	6	0.082	10	250	10000
MHIN1840075	3"	75	49	1.4	7	0.111	10	200	9000
MHIN1840090	3.5"	90	55	1.75	8	0.190	10	100	4000
MHIN1840100	4"	100	71	1.75	8	0.260	5	80	3200

FINISH AVAILABLE : SC, BZP, ZYP, EB, EXB, EXW, CP, SNP, SCP, PCP
 ANTIQUE BRASS, DUROSIL
 ALSO AVAILABLE IN RADIUS CORNER, CODE 1840RC

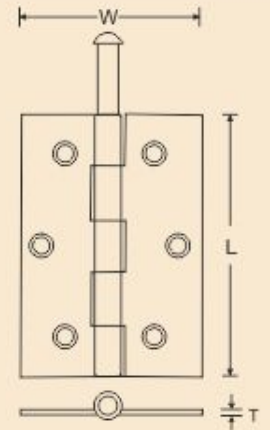

5050 : MILD STEEL NARROW BUTT HINGES UNCRANKED KNUCKLE, FIXED PIN



ITEM CODE	SIZE	LENGTH	WIDTH	THICKNESS	N.H.	SCREW NO.	WT/PAIR	PRS. IN INNER	PRS. IN OUTER	PRS. IN PALLET
MHIN5050025	1"	25	24	1.2	4	4	0.016	25	1400	63000
MHIN5050040	1.5"	40	32	1.4	4	4	0.035	10	600	21600
MHIN5050050	2"	50	37	1.5	6	6	0.056	10	400	16800
MHIN5050065	2.5"	65	41	1.5	6	6	0.085	10	250	10000
MHIN5050075	3"	75	47	1.5	6	7	0.116	10	160	9000
MHIN5050090	3.5"	90	54	1.7	6	7	0.190	10	100	4000
MHIN5050100	4"	100	58	1.7	8	8	0.220	5	80	3200
MHIN5050125	5"	125	65	1.7	8	8	0.315	5	50	2500
MHIN5050150	6"	150	75	2	8	10	0.456	5	30	1800

FINISH AVAILABLE : SC, BZP, ZYP, EB, EXB, EXW, CP, SNP, SCP, PCP
 ANTIQUE BRASS, DUROSIL

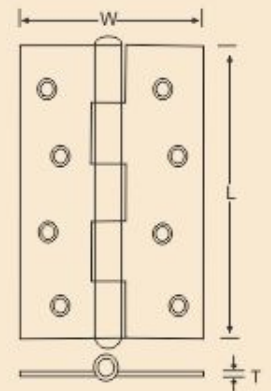

451 : MILD STEEL STRONG BUTT HINGES CRANKED KNUCKLE, FIXED PIN

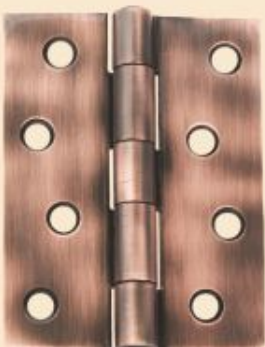

ITEM CODE	SIZE	LENGTH	WIDTH	THICKNESS	SCREW NO.	WT/PAIR	PRS. IN INNER	PRS. IN OUTER	PRS. IN PALLET
MHIN0451050	2"	50	42	2.5	8	0.115	10	200	6800
MHIN0451075	3"	76	64	2.5	10	0.270	10	80	3200
MHIN0451100	4"	101	75	2.6	10	0.420	5	50	2400
MHIN451H100	4"	101	76	3.55	12	0.550	5	40	1600

FINISH AVAILABLE : SC, BZP, ZYP, EB, EXB, EXW, CP, SNP, SCP, PCP
 ANTIQUE BRASS, DUROSIL
 ALSO AVAILABLE IN RADIUS CORNER, CODE 451RC

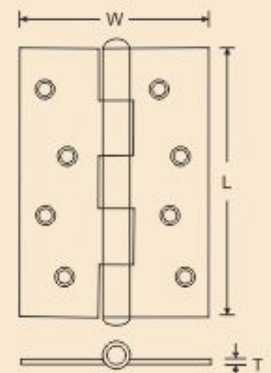

451 DPBW : MILD STEEL DOUBLE PHOSPHOROUS BRONZE WASHERED HINGES



ITEM CODE	SIZE	LENGTH	WIDTH	THICKNESS	SCREW NO.	WT/PAIR	PRS. IN INNER	PRS. IN OUTER	PRS. IN PALLET
MHIN1451075	3"	75	48	2.0	7	0.150	10	80	4000
MHIN1451100	4"	101	75	2.5	10	0.416	5	50	2400

FINISH AVAILABLE : SC, BZP, ZYP, EB, EXB, EXW, CP, SNP, SCP,
ANTIQUE BRASS, DUROSIL

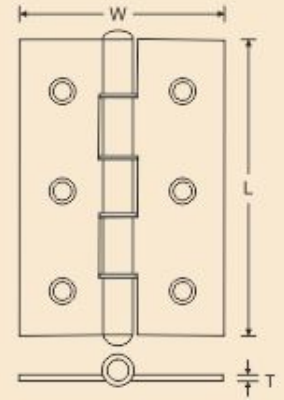

451 DSW : MILD STEEL DOUBLE STEEL WASHERED HINGES

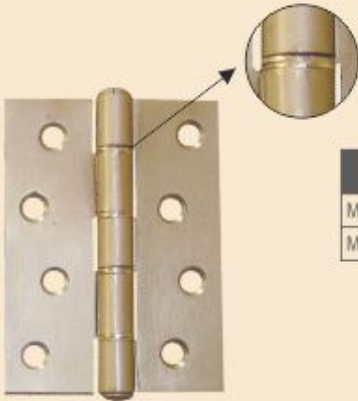

ITEM CODE	SIZE	LENGTH	WIDTH	THICKNESS	SCREW NO.	WT/PAIR	PRS. IN INNER	PRS. IN OUTER	PRS. IN PALLET
MHIN1454075	3"	75	48	2.0	7	0.150	10	80	4000
MHIN1454100	4"	101	75	2.5	10	0.416	5	50	2400

FINISH AVAILABLE : SC, BZP, ZYP, EB, EXB, EXW, CP, SNP, SCP,
ANTIQUE BRASS, DUROSIL

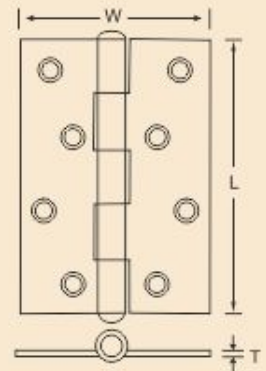

899 : MILD STEEL EXTRA STRONG DOUBLE FLAP BUTT HINGES UNCRANKED KNUCKLE, FIXED PIN



TECHNICAL DATA

ITEM CODE	SIZE	LENGTH	WIDTH	THICKNESS	SCREW NO.	WT/PAIR	PRS. IN INNER	PRS. IN OUTER	PRS. IN PALLET
MHIN0899075	3"	76	60	4.0	10	0.320	10	60	2400
MHIN0899100	4"	101	72	4.3	12	0.490	5	40	1600
MHIN0899150	6"	152	102	6.0	12	1.610	2	12	600

FINISH AVAILABLE : SC, BZP, ZYP, EB, EXB, EXW, CP, SNP, SCP,
ANTIQUE BRASS, DUROSIL

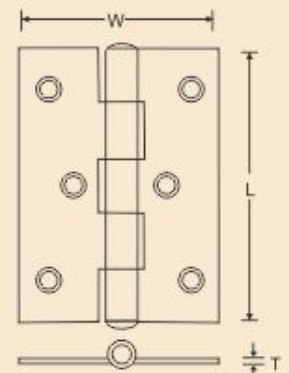

457 : MILD STEEL LIFT OFF HINGES - HANDED CRANKED KNUCKLE



TECHNICAL DATA

ITEM CODE	SIZE	LENGTH	WIDTH	THICKNESS	SCREW NO.	WT/ PAIR	PRS. IN INNER	PRS. IN OUTER	PRS. IN PALLET
MHIN457L065	2.5"	65	52	2.0	8	0.135	10	120	4800
MHIN457L075	3"	75	56	2.6	10	0.230	10	80	4320
MHIN457L100	4"	100	73	2.6	10	0.364	5	50	2000
MHIN457R065	2.5"	65	52	2.0	8	0.135	10	120	4800
MHIN457R075	3"	75	56	2.6	10	0.230	10	80	4320
MHIN457R100	4"	100	73	2.6	10	0.364	5	50	2000

FINISH AVAILABLE : SC, BZP, ZYP, EB, EXB, EXW, CP, SNP, SCP,
ANTIQUE BRASS, DUROSIL

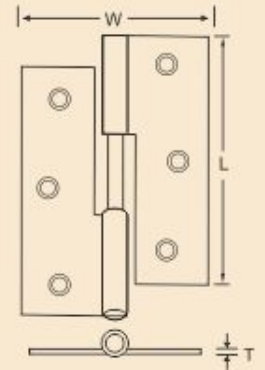

466 : MILD STEEL RISING BUTT HINGES HANDED - CRANKED KNUCKLE LIFT - OFF PATTERN, FLUSH PIN



TECHNICAL DATA

ITEM CODE	SIZE	LENGTH	WIDTH	THICKNESS	SCREW NO.	WT/PAIR	PRS. IN INNER	PRS. IN OUTER	PRS. IN PALLET
MHIN466L075	3"	76	73	2.55	8	0.320	5	70	2100
MHIN466L100	4"	100	77	2.8	10	0.530	5	35	1890
MHIN466R075	3"	76	73	2.55	8	0.320	5	70	2100
MHIN466R100	4"	100	77	2.8	10	0.530	5	35	1890

FINISH AVAILABLE : SC, BZP, ZYP, EB, EXB, EXW, CP, SNP, SCP, PCP
ANTIQUE BRASS, DUROSIL

NOTE : ALSO AVAILABLE IN STAINLESS STEEL 18/8 (GR.-304) CODE 466SS

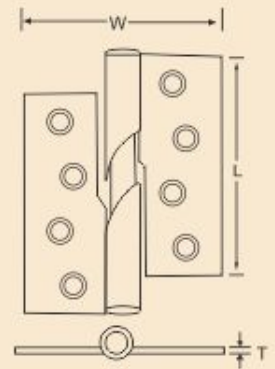

458RC : MILD STEEL RADIUS CORNER HINGES HANDED - CRANKED KNUCKLE, LIFT - OFF



TECHNICAL DATA

ITEM CODE	SIZE	LENGTH	WIDTH	THICKNESS	SCREW NO.	WT/ PAIR	PRS. IN INNER	PRS. IN OUTER	PRS. IN PALLET
MHIN458R080	3"	80	80	2.5	7	0.314	5	80	2700
MHIN458L080	3"	80	80	2.5	7	0.314	5	80	2700

FINISH AVAILABLE : SC, BZP, ZYP, EB, EXB, EXW, CP, SNP, SCP, PCP
ANTIQUE BRASS, DUROSIL

NOTE : ALSO AVAILABLE IN STAINLESS STEEL 18/8 (GR.-304) CODE 458SSRC

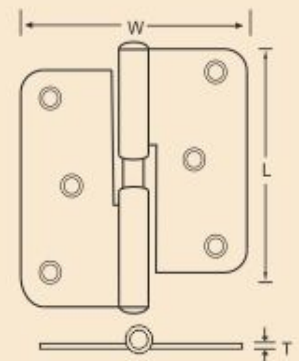

488 : MILD STEEL PARLIAMENT HINGES UNCRANKED KNUCKLE, FIXED PIN

TECHNICAL DATA



ITEM CODE	SIZE	LENGTH	WIDTH	THICKNESS	SCREW NO.	WT/ PAIR	PRS. IN INNER	PRS. IN OUTER	PRS. IN PALLET
MHINO488050	2"	100	50	2.24	8	0.285	10	80	3040
MHINO488065	2.5"	100	65	2.24	8	0.305	10	70	1960
MHINO488075	3"	100	75	2.24	8	0.320	5	70	1960
MHINO488100	4"	125	100	2.5	8	0.600	5	35	1260
MHINO488125	5"	125	125	2.5	10	0.672	5	30	1260
MHINO488150	6"	125	150	2.5	10	0.716	5	30	1260
MHINO488200	8"	125	200	2.5	10	0.882	5	20	1000

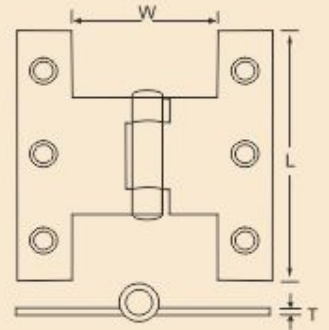

FINISH AVAILABLE : SC, BZP, ZYP, EB, EXB, EXW, CP, SNP, SCP,
ANTIQUE BRASS, DUROSIL

3210 : MILD STEEL HALF ROUND PARLIAMENT HINGES (UNCRANKED KNUCKLE, FIXED PIN)

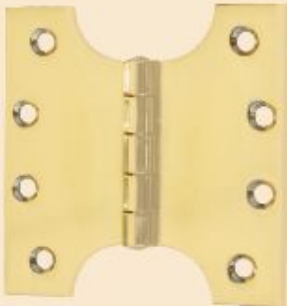

TECHNICAL DATA

ITEM CODE	SIZE	LENGTH	WIDTH	THICKNESS	SCREW NO.	WT/ PAIR	PRS. IN INNER	PRS. IN OUTER	PRS. IN PALLET
MHIN3210100	4"x2"x4"x3mm	101	50	3.0	10	0.440	10	40	1800

FINISH AVAILABLE : SC, BZP, ZYP, EB, EXB, EXW, CP, SNP, SCP,
ANTIQUE BRASS, DUROSIL

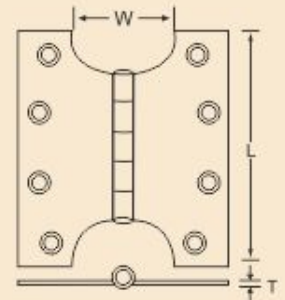

1954 : MILD STEEL FOUR BALL BEARING STORMPROOF HINGE



TECHNICAL DATA

ITEM CODE	SIZE	LENGTH	WIDTH	THICKNESS	SCREW NO.	WT/ PAIR	PRS. IN INNER	PRS. IN OUTER	PRS. IN PALLET
MHIN1954125	5"	127	132	5.0	12	1.964	1	10	400

FINISH AVAILABLE : SC, BZP, ZYP, EB, EXB, EXW, CP, SNP, SCP,
ANTIQUE BRASS, DUROSIL

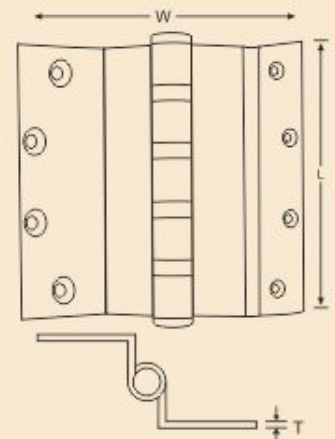

1951 : MILD STEEL STORMPROOF BUTT HINGES FIXED PIN



TECHNICAL DATA

ITEM CODE	SIZE	LENGTH	WIDTH	THICKNESS	SCREW NO.	WT/ PAIR	PRS. IN INNER	PRS. IN OUTER	PRS. IN PALLET
MHIN1951063	2.5"	63	58	1.7	8	0.175	10	120	5400
MHIN1951100	4"	101	72	2.0	8	0.400	5	40	1800

FINISH AVAILABLE : SC, BZP, ZYP, EB, EXB, EXW, CP, SNP, SCP,
ANTIQUE BRASS, DUROSIL

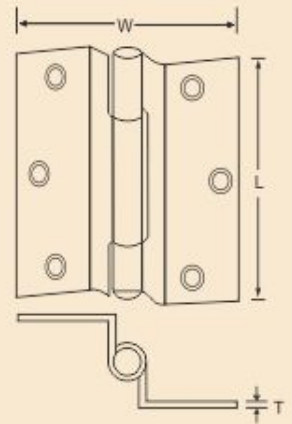

1951FF : MILD STEEL STORMPROOF HINGES (UNEQUAL)



TECHNICAL DATA

ITEM CODE	SIZE	LENGTH	WIDTH	THICKNESS	SCREW NO.	WT/ PAIR	PRS. IN INNER	PRS. IN OUTER	PRS. IN PALLET
MHIN1954063	2.5"	63	63	1.8	8	0.180	10	120	5400

FINISH AVAILABLE : SC, BZP, ZYP, EB, EXB, EXW, CP, SNP, SCP,
ANTIQUE BRASS, DUROSIL

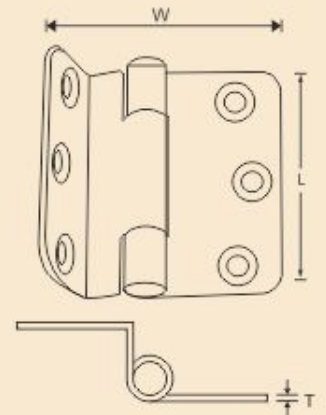

1951EH : MILD STEEL STORMPROOF HINGES (EXTRA HOLES)



TECHNICAL DATA

ITEM CODE	SIZE	LENGTH	WIDTH	THICKNESS	SCREW NO.	WT/ PAIR	PRS. IN INNER	PRS. IN OUTER	PRS. IN PALLET
MHIN1956063	2.5"	63	58	1.8	8	0.180	10	120	5400

FINISH AVAILABLE : SC, BZP, ZYP, EB, EXB, EXW, CP, SNP, SCP,
ANTIQUE BRASS, DUROSIL

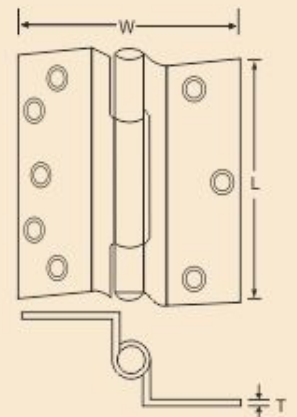

1951CR : MILD STEEL STORMPROOF HINGE WITH GAP



TECHNICAL DATA

DPG CODE	ITEM CODE	SIZE	LENGTH	WIDTH	THICKNESS	FLAP GAP	SCREW NO.	WT/ PAIR	PRS. IN INNER	PRS. IN OUTER	PRS. IN PALLET
	MHIN3207063	2.5"	63	58	1.6	8	7	0.154	10	120	5400
	MHIN3208063	2.5"	63	58	1.6	5	7	0.164	10	120	5400

FINISH AVAILABLE : SC, BZP, ZYP, EB, EXB, EXW, CP, SNP, SCP,
ANTIQUE BRASS, DUROSIL

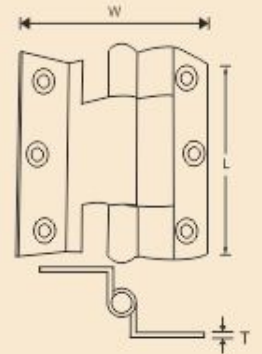

1957 : MILD STEEL STORMPROOF HINGE C/W EXTENDED INNER FLAP



TECHNICAL DATA

ITEM CODE	SIZE	LENGTH	WIDTH	THICKNESS	SCREW NO.	WT/ PAIR	PRS. IN INNER	PRS. IN OUTER	PRS. IN PALLET
MHIN1957065	2.5	63	71	1.8	7	0.202	10	120	5400

FINISH AVAILABLE : SC, BZP, ZYP, EB, EXB, EXW, CP, SNP, SCP,
ANTIQUE BRASS, DUROSIL

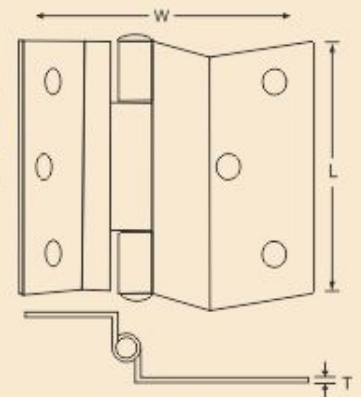

459 : MILD STEEL SUPPORTING HINGES (OR) OFFSET HINGES - HANDED - CRANKED KNUCKLE



TECHNICAL DATA

ITEM CODE	SIZE	LENGTH	WIDTH	THICKNESS	SCREW NO.	WT/ PAIR	PRS. IN INNER	PRS. IN OUTER	PRS. IN PALLET
MHIN459R100	4"	100	86	3.0	10	0.600	5	30	1350
MHIN459R110	4.5"	110	96	3.0	12	0.630	5	30	1350
MHIN459L100	4"	100	86	3.0	10	0.600	5	30	1350
MHIN459L110	4.5"	110	96	3.0	12	0.630	5	30	1350

FINISH AVAILABLE : SC, BZP, ZYP, EB, EXB, EXW, CP, SNP, SCP,
ANTIQUE BRASS, DUROSIL
AVAILABLE IN L/H & R/H

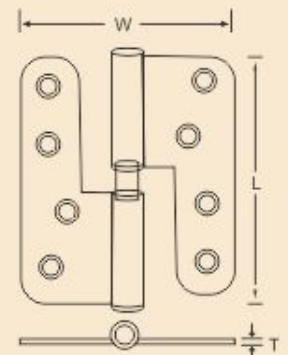

460 : MILD STEEL JOURNAL SUPPORT HINGES HANDED - CRANKED & KNOTCHED KNUCKLE (WITH OIL SLOT)



TECHNICAL DATA

ITEM CODE	SIZE	LENGTH	WIDTH	THICKNESS	SCREW NO.	WT/ PAIR	PRS. IN INNER	PRS. IN OUTER	PRS. IN PALLET
MHIN460L098	4"	98	81	2.5	10	0.435	5	50	1800
MHIN460L110	4.5"	110	98	3.15	10	0.656	5	30	1350
MHIN460R098	4"	98	81	2.5	10	0.435	5	50	1800
MHIN460R110	4.5"	110	98	3.15	10	0.656	5	30	1350

FINISH AVAILABLE : SC, BZP, ZYP, EB, EXB, EXW, CP, SNP, SCP,
ANTIQUE BRASS, DUROSIL
AVAILABLE IN L/H & R/H

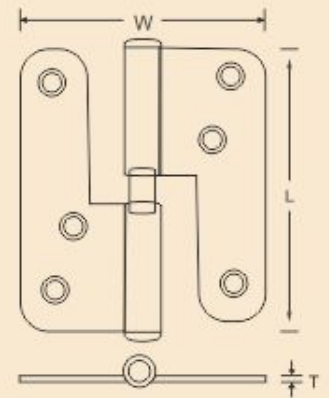

804H : MILD STEEL BROAD SQUARE HEAVY BUTT HINGES CRANKED KNUCKLE

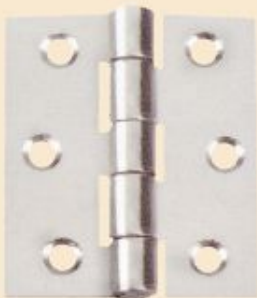

TECHNICAL DATA

ITEM CODE	SIZE	LENGTH	WIDTH	THICKNESS	SCREW NO.	WT/ PAIR	PRS. IN INNER	PRS. IN OUTER	PRS. IN PALLET
MHIN8041076	3"X3"	76	76	2.0	8	0.240	10	80	3200
MHIN8041080	3.15"X3.15"	80	80	2.5	8	0.280	10	80	3200
MHIN8041090	3.5"X3.5"	89	89	2.5	8	0.410	5	50	2000
MHIN8041101	4"X4"	101	101	3.1	12	0.640	5	35	1400
MHIN8041114	4.5"X4.5"	114	114	3.5	12	0.890	5	20	1000

FINISH AVAILABLE : SC, BZP, ZYP, EB, EXB, EXW, CP, SNP, SCP,
ANTIQUE BRASS, DUROSIL
ALSO AVAILABLE IN LOSSE PIN (COD 808HLP) AND IN RADIUS CORNER (CODE 808HRC)

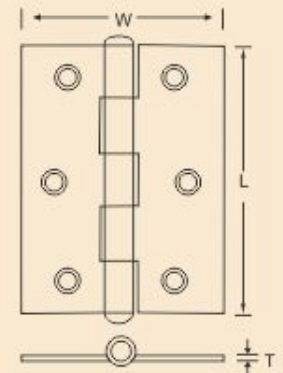

452DS/FP : MILD STEEL BUTT HINGES DOUBLE SECURITY PINS



TECHNICAL DATA

ITEM CODE	SIZE	LENGTH	WIDTH	THICKNESS	SCREW NO.	WT/ PAIR	PRS. IN INNER	PRS. IN OUTER	PRS. IN PALLET
MHIN1452100	4"X3.5"	101	90	2.5	8	0.450	5	50	1800

FINISH AVAILABLE : SC, BZP, ZYP, EB, EXB, EXW, CP, SNP, SCP,
ANTIQUE BRASS, DUROSIL
ALSO AVAILABLE : LOOSE PIN (CODE 452 DS/LP)

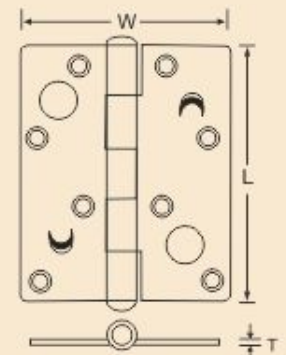

400 : MILD STEEL BACK FLAP (TABLE) HINGES CRANKED KNUCKLE, FIXED PIN



TECHNICAL DATA

ITEM CODE	SIZE	LENGTH	WIDTH	THICKNESS	SCREW NO.	WT/ PAIR	PRS. IN INNER	PRS. IN OUTER	PRS. IN PALLET
MHIN0400025	1"	25	74	1.6	6	0.052	25	400	16000
MHIN0400030	1.25"	30	77	1.6	7	0.062	10	300	16200
MHIN0400040	1.5"	40	87	1.6	8	0.099	10	150	9000
MHIN0400050	2"	50	106	2.0	8	0.182	10	100	5700
MHIN0400065	2.5"	65	153	2.2	10	0.360	10	50	2500
MHIN0400075	3"	75	168	2.5	10	0.500	5	50	1800

FINISH AVAILABLE : SC, BZP, ZYP, EB, EXB, EXW, CP, SNP, SCP,
ANTIQUE BRASS, DUROSIL
ALSO AVAILABLE UNCRANKED (404)

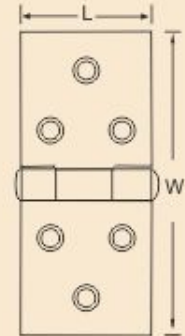

400BP : MILD STEEL BACK FLAP (TABLE) HINGES WITH BENT PIN



TECHNICAL DATA

ITEM CODE	SIZE	LENGTH	WIDTH	THICKNESS	SCREW NO.	WT/ PAIR	PRS. IN INNER	PRS. IN OUTER	PRS. IN PALLET
MHIN400B040	1.5"	40	85	1.5	7	0.098	10	150	9000
MHIN400B050	2"	50	104	2.0	8	0.185	10	100	5700

FINISH AVAILABLE : SC, BZP, ZYP, EB, EXB, EXW, CP, SNP, SCP,
ANTIQUE BRASS, DUROSIL
ALSO AVAILABLE UNCRANKED (404)

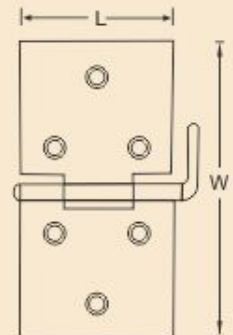

105 : MILD STEEL FLUSH HINGES UNCRANKED KNUCKLE, FIXED PIN



TECHNICAL DATA

ITEM CODE	SIZE	LENGTH	WIDTH	THICKNESS	SCREW NO.	WT/ PAIR	PRS. IN INNER	PRS. IN OUTER	PRS. IN PALLET
MHIN0105038	1.5"	40	32	1.0	4	0.020	25	1200	43200
MHIN0105050	2"	50	38	1.2	4	0.031	25	600	27000
MHIN0105065	2.5"	60	40	1.2	4	0.036	25	500	27000
MHIN0105075	3"	76	52	1.5	6	0.089	25	225	9000
MHIN0105100	4"	100	60	2.0	8	0.228	10	100	4000

FINISH AVAILABLE : SC, BZP, ZYP, EB, EXB, EXW, CP, SNP, SCP,
ANTIQUE BRASS, DUROSIL

NOTE : ALSO AVAILABLE IN FINIAL PINS (CODE 105FLP) ROUNDED CORNERS (CODE 105RC)
AND ROUNDED CORNERS WITH FINIAL PINS (105RCF)

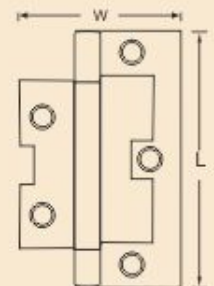

118 : MILD STEEL CRANKED FLUSH HINGE



TECHNICAL DATA

ITEM CODE	SIZE	LENGTH	WIDTH	THICKNESS	SCREW NO.	WT/ PAIR	PRS. IN INNER	PRS. IN OUTER	PRS. IN PALLET
MHIN0118050	2"	51	40	1.2	4	0.040	25	400	20000

FINISH AVAILABLE : SC, BZP, ZYP, EB, EXB, EXW, CP, SNP, SCP,
ANTIQUE BRASS, DUROSIL

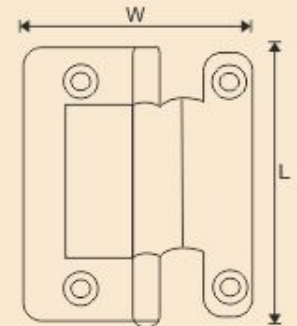

115 : MILD STEEL CRANKED FLUSH HINGE



TECHNICAL DATA

ITEM CODE	SIZE	LENGTH	WIDTH	THICKNESS	SCREW NO.	WT/ PAIR	PRS. IN INNER	PRS. IN OUTER	PRS. IN PALLET
MHIN0115050	2"	50	40	1.2	5	0.045	25	400	20000

FINISH AVAILABLE : SC, BZP, ZYP, EB, EXB, EXW, CP, SNP, SCP,
ANTIQUE BRASS, DUROSIL

NOTE : ALSO AVAILABLE IN FINIAL PINS (CODE 105FLP) ROUNDED CORNERS (CODE 105RC)
AND ROUNDED CORNERS WITH FINIAL PINS (105RCF)

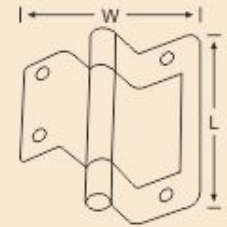

105EFH : ELONGATED FLUSH HINGE



TECHNICAL DATA

ITEM CODE	SIZE	LENGTH	WIDTH	THICKNESS	SCREW NO.	WT/ PAIR	PRS. IN INNER	PRS. IN OUTER	PRS. IN PALLET
MHIN105E075	3"	75	80	1.5	6	0.106	25	200	9000

FINISH AVAILABLE : SC, BZP, ZYP, EB, EXB, EXW, CP, SNP, SCP,
ANTIQUE BRASS, DUROSIL

NOTE : ALSO AVAILABLE IN FINIAL PINS (CODE 105FLP) ROUNDED CORNERS (CODE 105RC)
AND ROUNDED CORNERS WITH FINIAL PINS (105RCF)

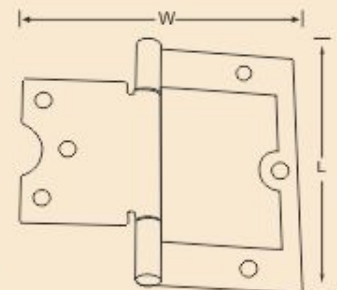

104FP : MILD STEEL HURLINGE, RADIUS CORNER CRANKED KNUCKLE, FIXED PIN



TECHNICAL DATA

ITEM CODE	SIZE	LENGTH	WIDTH	THICKNESS	SCREW NO.	WT/ PAIR	PRS. IN INNER	PRS. IN OUTER	PRS. IN PALLET
MHIN1041050	2"	50	34	1.2	4	0.032	25	600	27000
MHIN1041065	2.5"	60	38	1.2	6	0.042	25	500	20000
MHIN1041075	3"	76	51	1.5	7	0.096	25	225	9000
MHIN1041100	4"	101	63	2.0	8	0.180	10	100	4000

FINISH AVAILABLE : SC, BZP, ZYP, EB, EXB, EXW, CP, SNP, SCP, ANTIQUE BRASS, DUROSIL

NOTE : ALSO AVAILABLE IN REMOVABLE PIN (CODE 104LP)

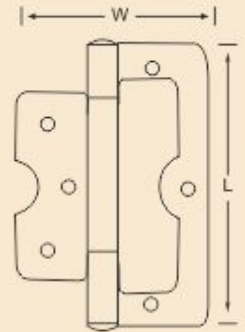

106 : MILD STEEL CABINET HINGES FIXED PIN



TECHNICAL DATA

ITEM CODE	SIZE	LENGTH	WIDTH	THICKNESS	SCREW NO.	WT/ PAIR	PRS. IN INNER	PRS. IN OUTER	PRS. IN PALLET
MHIN0106065	2.5"	63	60	1.5	6	0.092	25	200	9600
MHIN0106100	4"	100	62	1.5	7	0.140	20	160	6080

FINISH AVAILABLE : SC, BZP, ZYP, EB, EXB, EXW, CP, SNP, SCP, ANTIQUE BRASS, DUROSIL

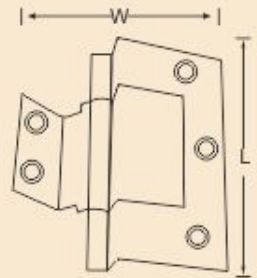

108 : MILD STEEL CRANKED (EASY HANG) HINGE FIXED PIN



TECHNICAL DATA

ITEM CODE	SIZE	LENGTH	WIDTH	THICKNESS	SCREW NO.	WT/ PAIR	PRS. IN INNER	PRS. IN OUTER	PRS. IN PALLET
MHIN0108050	2"	51	72	1.2	4	0.060	25	400	14400

FINISH AVAILABLE : SC, BZP, ZYP, EB, EXB, EXW, CP, SNP, SCP, ANTIQUE BRASS, DUROSIL

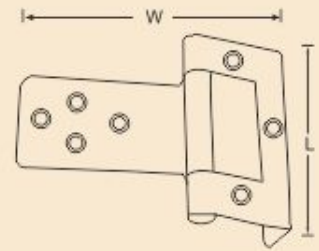

109 : MILD STEEL DOUBLE CRANKED HINGE FIXED PIN



TECHNICAL DATA

ITEM CODE	SIZE	LENGTH	WIDTH	THICKNESS	SCREW NO.	WT/ PAIR	PRS. IN INNER	PRS. IN OUTER	PRS. IN PALLET
MHIND109060	2.5"	60	90	1.6	7	0.115	5	150	6750

FINISH AVAILABLE : SC, BZP, ZYP, EB, EXB, EXW, CP, SNP, SCP,
ANTIQUE BRASS, DUROSIL

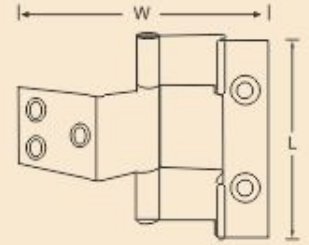

1386 : MILD STEEL FANCY CABINET HINGE (BUTTERFLY)



TECHNICAL DATA

ITEM CODE	SIZE	LENGTH	WIDTH	THICKNESS	SCREW NO.	WT/ PAIR	PRS. IN INNER	PRS. IN OUTER	PRS. IN PALLET
MHIN1386042	1.75"	42	34	1.0	4	0.014	50	1200	54000
MHIN1386051	2"	51	41	1.0	4	0.022	50	1000	40000

FINISH AVAILABLE : SC, BZP, ZYP, EB, EXB, EXW, CP, SNP, SCP,
ANTIQUE BRASS, DUROSIL

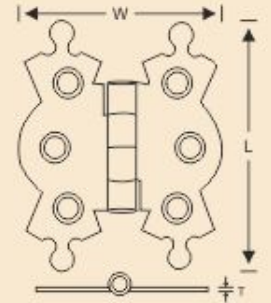

1387 : MILD STEEL SEAT HINGE



TECHNICAL DATA

ITEM CODE	SIZE	LENGTH	WIDTH	THICKNESS	SCREW NO.	WT/PAIR	PRS. IN INNER	PRS. IN OUTER	PRS. IN PALLET
MHIN1387064	1.5"	38	64	1.0	4	0.044	20	300	16200

FINISH AVAILABLE : SC, BZP, ZYP, EB, EXB, EXW, CP, SNP, SCP,
ANTIQUE BRASS, DUROSIL

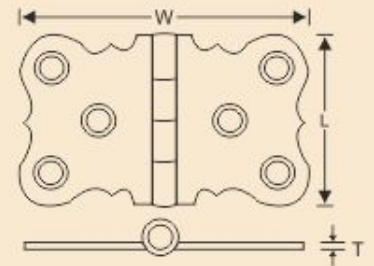

STAINLESS STEEL RAILWAY HINGES

TECHNICAL DATA



Patent No.
406696

DPG CODE	ITEM CODE	SIZE	LENGTH	WIDTH	THICKNESS	N.H	SCREW NO	WT/ PCS	PCS.IN INNER	PCS.IN INNER	PCS.IN PALLET
HNGS1201	SHIN1201100	4"X28	101.6	66	3.20	8	8	0.171	5	100	3000
HNGS1202	SHIN1202100	4"X31.5	101.6	73	3.00	8	8	0.190	5	100	3000
HNGS1203	SHIN1203125	5"X28	127.0	66	3.50	10	10	0.230	5	60	1800
HNGS1204	SHIN1204125	5"X31.5	127.0	73	3.50	10	10	0.254	5	60	1800
HNGS1205	SHIN1205125	5"X38	127.0	86	4.00	10	10	0.332	5	60	1800
HNGS1206	SHIN1206150	6"X28	152.4	66	3.50	10	10	0.310	5	50	2100
HNGS1207	SHIN1207150	6"X31.5	152.4	73	3.50	10	10	0.340	5	50	2100
HNGS1208	SHIN1208150	6"X38	152.4	86	4.00	10	10	0.419	5	50	2100
HNGS1209	SHIN1209200	8"X31.5	203.2	73	5.00	10	10	0.610	5	30	900
HNGS1210	SHIN1210200	8"X38	203.2	86	5.00	10	10	0.710	5	30	900

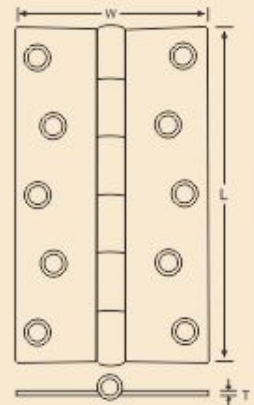

FINISH AVAILABLE : MIRROR POLISHED, ELECTRO BRASS, SATIN, BLACK NICKEL

279 : MILD STEEL SINGLE ACTION SPRING HINGES



TECHNICAL DATA

ITEM CODE	SIZE	LENGTH	WIDTH	THICKNESS	SCREW NO	WT/ PCS	PCS.IN INNER	PCS.IN OUTER	PCS.IN PALLET
MHINO279075	3"	75	68	1.60	4	0.277	10	60	2520
MHINO279100	4"	100	81	2.00	6	0.376	4	40	1800
MHINO279125	5"	125	96	2.00	6	0.475	4	40	1400

FINISH AVAILABLE : SC, BZP, ZYP, EB, EXB, EXW, CP, SNP, SCP, SILVER

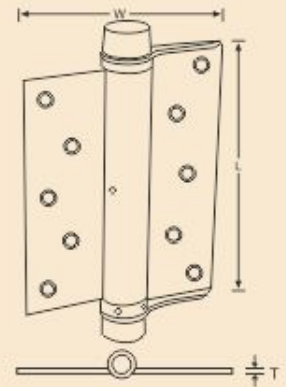

280 : MILD STEEL DOUBLE ACTION SPRING HINGES



TECHNICAL DATA

ITEM CODE	SIZE	LENGTH	WIDTH	THICKNESS	SCREW NO	WT/ PCS	PCS.IN INNER	PCS.IN OUTER	PCS.IN PALLET
MHINO280075	3"	75	118	1.60	4	0.530	10	40	1440
MHINO280100	4"	100	135	2.00	6	0.720	4	20	1200
MHINO280125	5"	125	158	2.00	6	0.884	4	20	800

FINISH AVAILABLE : SC, BZP, ZYP, EB, EXB, EXW, CP, SNP, SCP, SILVER

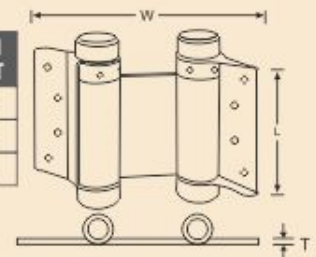

1841 : MILD STEEL BUTT HINGES CRANKED KNUCKLE FIXED / REMOVABLE PIN (AUSTRALIAN SPECIFICATION)



TECHNICAL DATA

ITEM CODE	SIZE	LENGTH	WIDTH	THICKNESS	SCREW NO.	WT/ PAIR	PRS. IN INNER	PRS. IN OUTER	PRS. IN PALLET
MHIN1841070	2.75"	70	50	1.6	8	0.125	10	200	6800
MHIN1841085	3.5"	85	61	1.7	8	0.180	10	100	4500

FINISH AVAILABLE : SC, BZP, ZYP, EB, EXB, EXW, CP, SNP, SCP,
ANTIQUE BRASS, DUROSIL

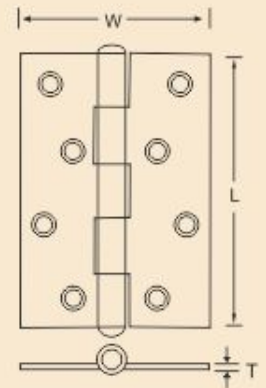

1842 : MILD STEEL BUTT HINGES UNCRANKED KNUCKLE, FIXED PIN (FRENCH SPECIFICATION)

TECHNICAL DATA

ITEM CODE	SIZE	LENGTH	WIDTH	THICKNESS	SCREW NO.	WT/ PAIR	PRS. IN INNER	PRS. IN OUTER	PRS. IN PALLET
MHIN1842025	1"	25	18	1.0	2	0.009	50	2000	88000
MHIN1842030	1"	30	19	1.0	2	0.012	50	1500	66000
MHIN1842035	1.25"	35	22	1.0	4	0.016	50	1200	54000
MHIN1842040	1.5"	40	25	1.0	4	0.024	50	800	32000
MHIN1842050	2"	50	30	1.0	4	0.032	25	600	24000
MHIN1842060	2.5"	60	35	1.0	4	0.044	25	400	20000
MHIN1842070	2.75"	70	40	1.2	6	0.076	25	250	11250
MHIN1842080	3"	80	45	1.2	7	0.104	25	200	6000
MHIN1842090	3.5"	90	45	1.5	7	0.144	25	150	6000
MHIN1842100	4"	100	50	1.5	7	0.164	25	100	5000

FINISH AVAILABLE : SC, BZP, ZYP, EB, EXB, EXW, CP, SNP, SCP,
ANTIQUE BRASS, DUROSIL

ALSO AVAILABLE IN BRASS & STAINLESS STEEL

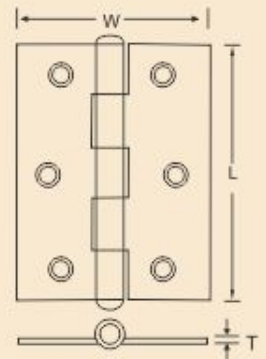

804 : MILD STEEL SQUARE BUTT HINGES UNCRANKED KNUCKLE, FIXED PIN (FRENCH SPECIFICATION)

TECHNICAL DATA

ITEM CODE	LENGTH	WIDTH	THICKNESS	SCREW NO.	WT/ PAIR	PRS. IN INNER	PRS. IN OUTER	PRS. IN PALLET
MHIN0804030	30	30	1.0	4	0.018	50	1000	44000
MHIN0804040	40	40	1.0	4	0.033	50	600	24000
MHIN0804050	50	50	1.0	6	0.048	25	400	16000
MHIN0804060	60	60	1.0	6	0.076	25	250	11250
MHIN0804070	70	70	1.2	7	0.120	25	150	6000
MHIN0804080	80	80	1.2	7	0.144	25	150	6000

FINISH AVAILABLE : SC, BZP, ZYP, EB, EXB, EXW, CP, SNP, SCP,
ANTIQUE BRASS, DUROSIL

ALSO AVAILABLE IN BRASS & STAINLESS STEEL

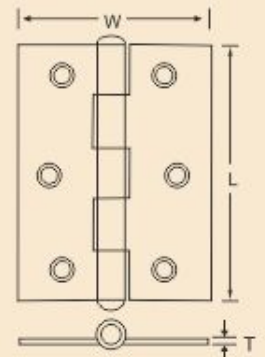

MILD STEEL BUTT HINGE (US SPECIFICATION)



TECHNICAL DATA

DPG CODE	ITEM CODE	SIZE	LENGTH	WIDTH	THICKNESS	SCREW NO.	WT/ PAIR	PRS. IN INNER	PRS. IN OUTER	PRS. IN PALLET
3903	MHIN3903090	3.5"	89	89	2.2	8	0.338	10	50	2250
3904	MHIN3904100	4"	101	101	2.5	8	0.490	5	40	1440

FINISH AVAILABLE : SC, BZP, ZYP, EB, EXB, EXW, CP, SNP, SCP, EXG,
ANTIQUE BRASS, DUROSIL

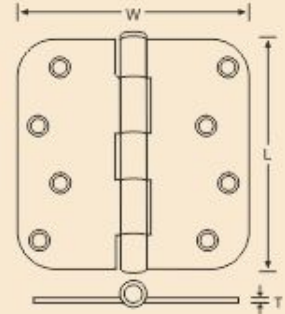

1838LW : MILD STEEL BUTT HINGES CRANKED KNUCKLE FIXED PIN (SRI LANKA/DUBAI SPECIFICATION)



TECHNICAL DATA

ITEM CODE	SIZE	LENGTH	WIDTH	THICKNESS	SCREW NO.	WT/ PAIR	PAIR IN INNER	PAIR IN OUTER	PCS. IN PALLET
MHIN1839075	3"	75	44	1.25	7	0.095	10	200	9000
MHIN1839100	4"	100	65	1.6	8	0.168	5	80	3200

FINISH AVAILABLE : SC, BZP, ZYP, EB, EXB, EXW, CP, SNP, SCP,
ANTIQUE BRASS, DUROSIL

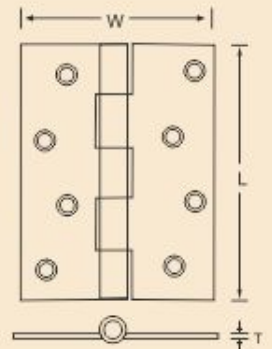

36 : MILD STEEL CONTAINER HINGE



TECHNICAL DATA

ITEM CODE	SIZE	LENGTH	WIDTH	THICKNESS	SCREW NO.	WT/ PAIR	PRS. IN INNER	PRS. IN OUTER	PRS. IN PALLET
MHIN0036180	7"	180	50	4.0	12	0.615	5	50	1000

FINISH AVAILABLE : SC, BZP, ZYP, EB, EXB, EXW, CP, SNP, SCP,
ANTIQUE BRASS, DUROSIL

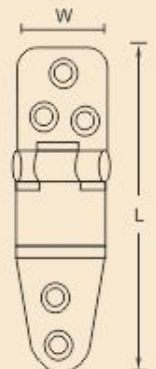

101 : MILD STEEL CONTINUOUS PIANO HINGE (UNCRANKED KNUCKLE, FLUSH PIN)



TECHNICAL DATA

WIDTH	THICKNESS	LENGTH (MM)	SCREW NO.	FINISH AVAILABLE
25,32,40,50	0.60	UPTO 2130	4	ZPEB,NPEXBR
25,32,40,50	0.60	UPTO 3500	4	ZP,ZYPEB
25,32,35,40,50	0.80	UPTO 2130	4	ZPNPOXD,EB,
30,35,40,50	1.20	UPTO 2130	6	ZPNPOXD,EB
40,50,60,75	1.60	UPTO 2130	6	ZPNPOXD,EB

NOTES: ALSO AVAILABLE (I) UNDRILLED PIANO HINGES(CODES 101A)
 (II) STAINLESS STEEL (CODES 101SS & 101ASS)
 (III) STEEL CRANKED PIANO HINGES WITH 12MM GAP (CODE 101CR)
 AVAILABLE IN SOLID BRASS



Cabinet Hinges

TECHNICAL DATA

DPG CODE	ITEM CODE	ITEM NAME	SIZE	SCREW NO.	WT/ PAIR	PRS. IN INNER	PRS. IN OUTER	PRS. IN PALLET
GF0101	MHINO101026	CABINET HINGE, UNSPRUNG, 90°	26	6	0.066	5	100	3000
GF0111	MHINO111026	CABINET HINGE, SPRUNG, 90°	26	6	0.068	5	100	3000
GF0102	MHINO102035	CABINET HINGE, UNSPRUNG, 90°	35	6	0.130	5	50	1800
GF0112	MHINO112035	CABINET HINGE, SPRUNG, 90°	35	6	0.134	5	50	1800
GF0113	MHINO113035	SOFT CLOSE CABINET HINGE, SPRUNG, 0°	35	6	0.206	5	50	1800
GF0114	MHINO114035	SOFT CLOSE CABINET HINGE, SPRUNG, 8°	35	6	0.210	5	50	1800
GF0115	MHINO115035	CLIP ON CABINET HINGE, SPRUNG, 90°	35	6	0.208	5	50	1800
GF0117	MHINO117035	SOFT CLOSE CABINET HINGE, SPRUNG, 15°	35	6	0.208	5	50	1800
GF0151	MHINO151170	CABINET HINGE, SPRUNG, 170°	35	6	0.258	5	50	600
GF0155	MHINO155170	CLIP ON CABINET HINGE, SPRUNG, 170°	35	6	0.262	5	50	600
GF0201	MHINO201100	SURFACE MOUNT HINGE, SPRUNG, 90°	100	6	0.150	5	50	1800

FINISH AVAILABLE : NICKEL PLATED, ZP



GF0101



GF0111



GF0102



GF0112



GF0115



GF0201



GF0151



GF0155



GF0113



GF0114



GF0117

BRASS EXTRUDED BUTT HINGES

TECHNICAL DATA



DPG CODE	SIZE	ITEM CODE	LENGTH	WIDTH	THICKNESS	SCREW NO.	WT/ PAIR	PRS. IN INNER	PRS. IN OUTER	PRS. IN PALLET
GB1200	1"	BHIN1200025	25	19	1.4	4	0.015	10	1000	52000
GB1200	1.5"	BHIN1200038	38	22	1.4	4	0.024	10	600	27000
GB1200	2"	BHIN1200050	50	29	1.4	4	0.044	10	400	13600
GB1200	2.5"	BHIN1200063	64	35	1.4	4	0.070	10	300	9900
GB1200	3"	BHIN1200075	75	40	1.5	6	0.096	10	160	6720
GB1200	4"	BHIN1200100	100	60	2.0	7	0.230	5	75	3150
GB1203	5"	BHIN1200125	125	100	3.0	8	0.710	5	25	1250

FINISH AVAILABLE : S/C, POLISHED & LACQUERED BRASS/CP/SNP/SCP/ANTIQUE BRASS

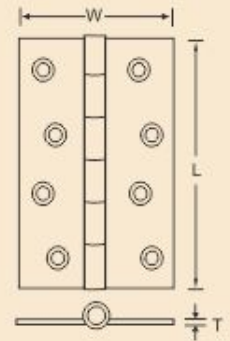

BRASS EXTRUDED BUTT HINGES



TECHNICAL DATA

DPG CODE	SIZE	ITEM CODE	LENGTH	WIDTH	THICKNESS	SCREW NO.	WT/ PAIR	PRS. IN INNER	PRS. IN OUTER	PRS. IN PALLET
GB1200	2"	BHIN1205050	50	32	1.4	4	0.052	10	300	10200
GB1200	3"	BHIN1206075	75	40	1.65	6	0.104	10	100	6000
GB1200	4"	BHIN1209100	100	66	2.0	8	0.267	5	75	3150

FINISH AVAILABLE : S/C, POLISHED & LACQUERED BRASS/CP/SNP/SCP/ANTIQUE BRASS

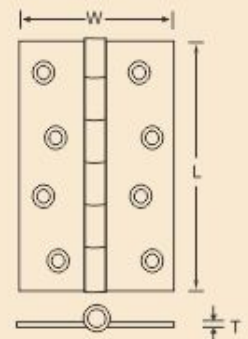

BRASS EXTRUDED BUTT HINGES



TECHNICAL DATA

DPG CODE	SIZE	ITEM CODE	LENGTH	WIDTH	THICKNESS	SCREW NO.	WT/ PAIR	PRS. IN INNER	PRS. IN OUTER	PRS. IN PALLET
GB1200	3"	BHIN1207075	75	40	2.0	7	0.120	10	100	6000
GB1201	4"	BHIN1201100	100	75	2.5	8	0.364	5	50	2250

FINISH AVAILABLE : S/C, POLISHED & LACQUERED BRASS/CP/SNP/SCP/ANTIQUE BRASS

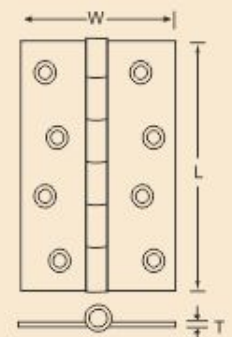

BRASS EXTRUDED BUTT HINGES



TECHNICAL DATA

DPG CODE	SIZE	ITEM CODE	LENGTH	WIDTH	THICKNESS	SCREW NO.	WT/ PAIR	PRS. IN INNER	PRS. IN OUTER	PRS. IN PALLET
GB1208	3"	BHIN1208075	75	50	2.0	7	0.156	5	75	4500
GB1210	4"	BHIN1210100	100	75	3.0	8	0.440	5	40	2000
GB1211	3"	BHIN1211076	76	50	2.2	7	0.165	5	75	4500

FINISH AVAILABLE : S/C, POLISHED & LACQUERED BRASS/CP/SNP/SCP/ANTIQUE BRASS

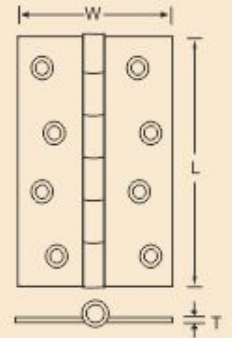

BRASS BUTT HINGES, WITH DOUBLE STEEL WASHERS (DSW)



TECHNICAL DATA

DPG CODE	SIZE	ITEM CODE	LENGTH	WIDTH	THICKNESS	SCREW NO.	WT/ PAIR	PRS. IN INNER	PRS. IN OUTER	PRS. IN PALLET
GB1300	3"	BHIN1300075	76	50	2.0	7	0.160	10	100	4000
GB1300	4"	BHIN1300100	100	67	2.0	8	0.270	5	60	2400

FINISH AVAILABLE : S/C, POLISHED & LACQUERED BRASS/CP/SNP/SCP/ANTIQUE BRASS

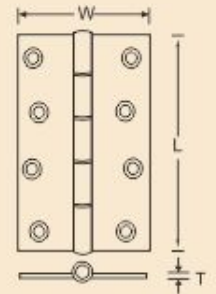

BRASS BUTT HINGES, WITH DOUBLE STEEL WASHERS (DSW)



TECHNICAL DATA

DPG CODE	SIZE	ITEM CODE	LENGTH	WIDTH	THICKNESS	SCREW NO.	WT/ PAIR	PRS. IN INNER	PRS. IN OUTER	PRS. IN PALLET
GB1300	4"	BHIN1301100	100	67	3.0	8	0.360	5	40	2080
GB1301	3"	BHIN1301075	75	50	2.5	8	0.190	10	100	4000
GB1306	4"	BHIN1306100	100	76	2.0	8	0.310	05	60	2400

FINISH AVAILABLE : S/C, POLISHED & LACQUERED BRASS/CP/SNP/SCP/ANTIQUE BRASS

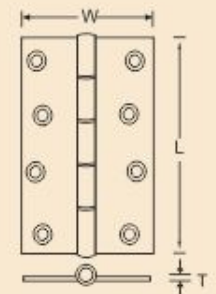

BRASS BUTT HINGES, WITH DOUBLE STEEL WASHERS (DSW)

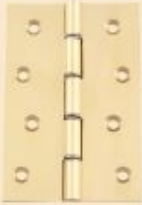

TECHNICAL DATA

DPG CODE	SIZE	ITEM CODE	LENGTH	WIDTH	THICKNESS	SCREW NO.	WT/ PAIR	PRS. IN INNER	PRS. IN OUTER	PRS. IN PALLET
GB1311	4"	BHIN13111100	100	67	3.5	10	0.454	5	25	1500
GB1303	4"	BHIN1303100	100	75	4.0	10	0.540	5	25	1500

FINISH AVAILABLE : S/C, POLISHED & LACQUERED BRASS/CP/SNP/SCP/ANTIQUE BRASS

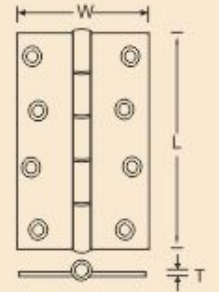

BRASS BUTT HINGES, WITH DOUBLE STEEL WASHERS (DSW)



TECHNICAL DATA

DPG CODE	SIZE	ITEM CODE	LENGTH	WIDTH	THICKNESS	SCREW NO.	WT/ PAIR	PRS. IN INNER	PRS. IN OUTER	PRS. IN PALLET
GB1302	4"	BHIN1302100	100	75	3.0	8	0.440	5	40	2080
GB1304	5"	BHIN1304125	125	75	3.0	8	0.530	5	40	1600
GB1305	5"	BHIN1305125	125	75	2.5	8	0.430	5	40	2000

FINISH AVAILABLE : S/C, POLISHED & LACQUERED BRASS/CP/SNP/SCP/ANTIQUE BRASS

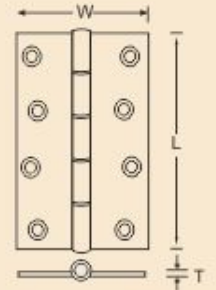

PHOSPORUS BRONZE WASHERED BRASS BUTT HINGE (DPBW)



TECHNICAL DATA

DPG CODE	SIZE	ITEM CODE	LENGTH	WIDTH	THICKNESS	SCREW NO.	WT/ PAIR	PRS. IN INNER	PRS. IN OUTER	PRS. IN PALLET
GB1350	3"	BHIN1350075	76	51	2.5	8	0.200	10	100	4000
GB1350	4"	BHIN1350100	101	67	3.5	10	0.444	5	40	1600

FINISH AVAILABLE : S/C, POLISHED & LACQUERED BRASS/CP/SNP/SCP/ANTIQUE BRASS

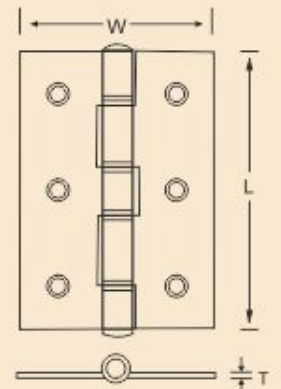

DOUBLE PHOSPORUS BRONZE WASHED BRASS BUTT HINGE (RADIUS CORNER) DPBW



TECHNICAL DATA

DPG CODE	SIZE	ITEM CODE	LENGTH	WIDTH	THICKNESS	SCREW NO.	WT/ PAIR	PRS. IN INNER	PRS. IN OUTER	PRS. IN PALLET
GB1380	3"	BHIN1380075	75	51	2.5	10	0.200	5	100	4000
GB1385	4"	BHIN1385100	102	67	2.5	8	0.320	5	40	2000
GB1386	4"	BHIN1386100	102	67	3.0	10	0.380	5	40	1800
GB1387	4"	BHIN1387100	102	76	3.0	10	0.430	5	40	1600

FINISH AVAILABLE : S/C, POLISHED & LACQUERED BRASS/CP/SNP/SCP/ANTIQUE BRASS

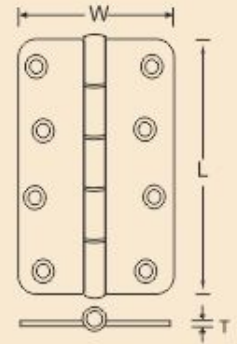

BRASS BUTT HINGES WITH TWO/FOUR BALL BEARING AND BUTTON TIP HEAD (S.S. PIN)



TECHNICAL DATA

DPG CODE	SIZE	ITEM CODE	LENGTH	WIDTH	THICKNESS	SCREW NO.	WT/ PAIR	PRS. IN INNER	PRS. IN OUTER	PRS. IN PALLET
GB1401	3"	BHIN1401075	75	65	3.0	10	0.340	5	50	2000
GB1402	4"	BHIN1402100	100	75	2.5	8	0.390	5	50	2000
GB1406	5"	BHIN1406125	125	90	5.0	10	1.200	5	15	600

FINISH AVAILABLE : S/C, POLISHED & LACQUERED BRASS/CP/SNP/SCP/ANTIQUE BRASS

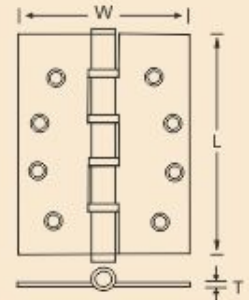

BRASS SQUARE BUTT HINGES



TECHNICAL DATA

DPG CODE	SIZE	ITEM CODE	LENGTH	WIDTH	THICKNESS	SCREW NO.	WT/ PAIR	PRS. IN INNER	PRS. IN OUTER	PRS. IN PALLET
GB1351	1.5"	BHIN1351040	38	38	1.5	4	0.052	10	200	12000
GB1352	2"	BHIN1352050	50	50	1.5	4	0.092	10	160	8000
GB1353	2.5"	BHIN1353065	63	63	1.8	6	0.164	10	100	5000
GB1354	3.5"	BHIN1354090	87	87	2.0	6	0.340	5	50	2000
GB1355	4"	BHIN1355100	100	100	3.0	8	0.600	2	30	1200

FINISH AVAILABLE : S/C, POLISHED & LACQUERED BRASS/CP/SNP/SCP/ANTIQUE BRASS

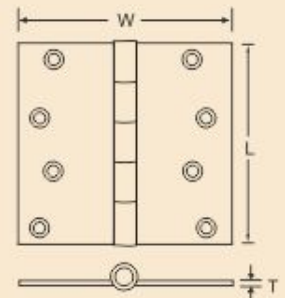

BRASS EXTRUDED BUTT HINGE (HEAVY)



TECHNICAL DATA

DPG CODE	ITEM CODE	SIZE	LIGHT	WIDTH	THICKNESS	SCREW NO.	WT/ PAIR	PRS. IN INNER	PRS. IN OUTER	PRS. IN PALLET
GB5914	BHIN5914100	4"x5"	100	125	4.0	10	0.930	01	10	720
GB5915	BHIN5915100	4"x6"	100	150	4.0	10	1.090	01	10	720

FINISH AVAILABLE : S/C, POLISHED & LACQUERED BRASS/CP/SNP/SCP/ANTIQUE BRASS

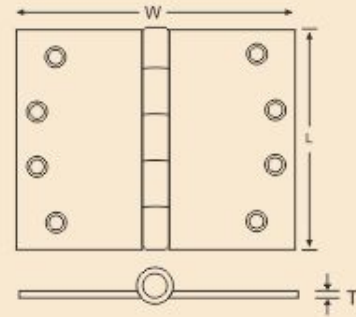

BRASS SQUARE BUTT HINGES WITH DOME HEAD PIN



TECHNICAL DATA

DPG CODE	SIZE	ITEM CODE	LENGTH	WIDTH	THICKNESS	SCREW NO.	WT/ PAIR	PRS. IN INNER	PRS. IN OUTER	PRS. IN PALLET
GB1500	1.5"	BHIN1500040	38	38	1.5	4	0.060	10	200	12000
GB1500	2"	BHIN1500050	50	50	1.6	6	0.103	10	160	6400
GB1500	2.5"	BHIN1500065	63	63	2.0	6	0.180	10	100	4000
GB1500	3.5"	BHIN1500090	89	89	2.2	6	0.360	5	50	2000
GB1500	4"	BHIN1500100	100	100	3.0	8	0.620	2	30	1200

FINISH AVAILABLE : S/C, POLISHED & LACQUERED BRASS/CP/SNP/SCP/ANTIQUE BRASS

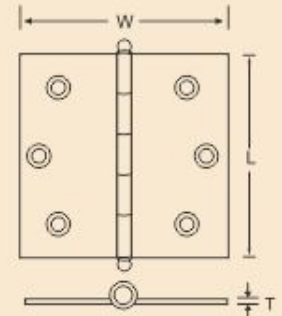

BRASS BUTT HINGES WITHOUT BALL BEARING AND TOMB HEAD (S.S. PIN)



TECHNICAL DATA

DPG CODE	SIZE	ITEM CODE	LENGTH	WIDTH	THICKNESS	SCREW NO.	WT/ PAIR	PRS. IN INNER	PRS. IN OUTER	PRS. IN PALLET
GB1501	3.5"	BHIN1501090	90	90	2.5	7	0.460	5	40	1600
GB1502	4"	BHIN1502100	100	90	2.5	7	0.540	5	40	1400

FINISH AVAILABLE : S/C, POLISHED & LACQUERED BRASS/CP/SNP/SCP/ANTIQUE BRASS

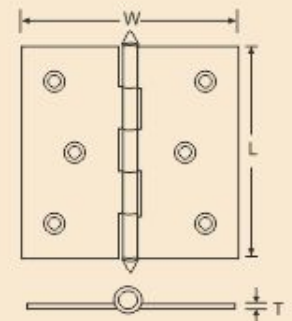

BRASS BUTT HINGES WITH TWO/FOUR BALL BEARING AND BUTTON TIP HEAD (S.S. PIN)



TECHNICAL DATA

DPG CODE	SIZE	ITEM CODE	LENGTH	WIDTH	THICKNESS	SCREW NO.	WT/ PAIR	PRS. IN INNER	PRS. IN OUTER	PRS. IN PALLET
GB1405	4"	BHIN1405100	100	100	3.0	10	0.770	5	25	1000

FINISH AVAILABLE : S/C, POLISHED & LACQUERED BRASS/CP/SNP/SCP/ANTIQUE BRASS

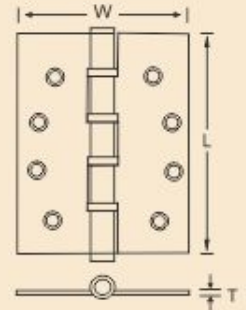

BRASS BUTT HINGES WITH TWO/FOUR BALL BEARING AND BUTTON TIP HEAD (S.S. PIN)



TECHNICAL DATA

DPG CODE	SIZE	ITEM CODE	LENGTH	WIDTH	THICKNESS	SCREW NO.	WT/ PAIR	PRS. IN INNER	PRS. IN OUTER	PRS. IN PALLET
GB1403	4"	BHIN1403100	100	90	2.5	10	0.520	5	40	1600

FINISH AVAILABLE : S/C, POLISHED & LACQUERED BRASS/CP/SNP/SCP/ANTIQUE BRASS

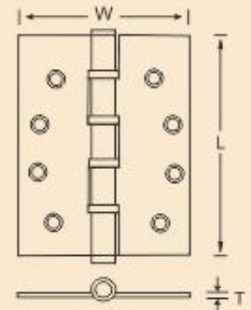

BRASS BUTT HINGES WITH TWO/FOUR BALL BEARING AND BUTTON TIP HEAD (S.S. PIN)



TECHNICAL DATA

DPG CODE	SIZE	ITEM CODE	LENGTH	WIDTH	THICKNESS	SCREW NO.	WT/ PAIR	PRS. IN INNER	PRS. IN OUTER	PRS. IN PALLET
GB1404	4"	BHIN1404100	100	75	3.0	10	0.560	5	25	1200

FINISH AVAILABLE : S/C, POLISHED & LACQUERED BRASS/CP/SNP/SCP/ANTIQUE BRASS

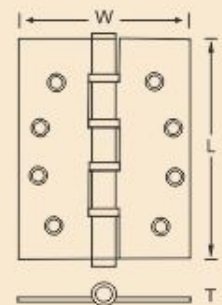

BRASS BUTT HINGE LOOSE PIN WITH FLAT BUTTON TIP HEAD (SS PIN)



TECHNICAL DATA

DPG CODE	ITEM CODE	SIZE	LENGTH	WIDTH	THICKNESS	SCREW NO.	WT/ PAIR	PRS. IN INNER	PRS. IN OUTER	PRS. IN PALLET
GB5906	BHIN5906101	4"	100	75	2.5	8	0.480	1	30	1440
GB5907	BHIN5907125	5"	125	75	2.5	8	0.590	1	30	1170
GB5908	BHIN5908150	6"	150	75	2.5	8	0.702	1	30	960

FINISH AVAILABLE : S/C, POLISHED & LACQUERED BRASS/CP/SNP/SCP/ANTIQUE BRASS

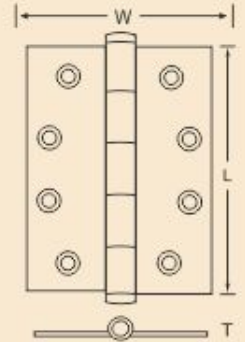

BRASS SQUARE BARREL BUTT HINGE (SS PIN)



TECHNICAL DATA

DPG CODE	ITEM CODE	SIZE	LENGTH	WIDTH	THICKNESS	SCREW NO.	WT/ PAIR	PRS. IN INNER	PRS. IN OUTER	PRS. IN PALLET
GB3165	BHIN3165100	4"	101	100	2.5	10	0.590	01	25	1200

FINISH AVAILABLE : S/C, POLISHED & LACQUERED BRASS/CP/SNP/SCP/ANTIQUE BRASS

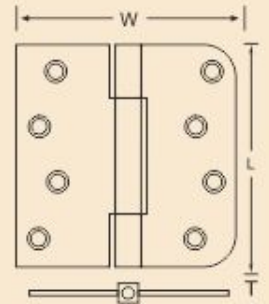

BRASS LIFT OFF HINGE WITH FLAT BUTTON TIP HEAD (SS PIN)



TECHNICAL DATA

DPG CODE	ITEM CODE	SIZE	LENGTH	WIDTH	THICKNESS	SCREW NO.	WT/ PAIR	PRS. IN INNER	PRS. IN OUTER	PRS. IN PALLET
GB1802	BHIN1802100	4"	100	75	2.5	8	0.442	1	30	1440

FINISH AVAILABLE : S/C, POLISHED & LACQUERED BRASS/CP/SNP/SCP/ANTIQUE BRASS

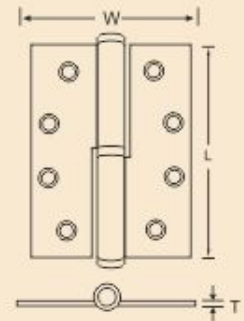

BRASS REFLECT HINGES (HANDED) (S.S. PIN)



TECHNICAL DATA

DPG CODE	SIZE	ITEM CODE	LENGTH	WIDTH	THICKNESS	SCREW NO.	WT/ PAIR	PRS. IN INNER	PRS. IN OUTER	PRS. IN PALLET
GB1801	4"	BHIN1801100	100	70	3.0	8	0.450	5	40	1600

FINISH AVAILABLE : S/C, POLISHED & LACQUERED BRASS/CP/SNP/SCP/ANTIQU BRASS

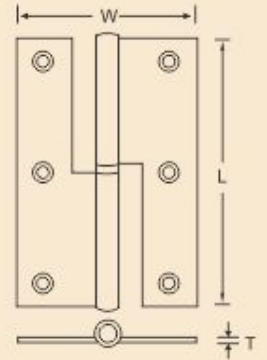

BRASS REFLECT HINGES WITH FLAT FLUSH / ROUND HEAD (S.S. PIN)



TECHNICAL DATA

DPG CODE	SIZE	ITEM CODE	LENGTH	WIDTH	THICKNESS	SCREW NO.	WT/ PAIR	PRS. IN INNER	PRS. IN OUTER	PRS. IN PALLET
GB1901	2.5"	BHIN1901065	65	48	2.0	7	0.150	10	100	5000
GB1902	3"	BHIN1902075	75	50	2.0	7	0.180	10	100	4000
GB1903	3.5"	BHIN1903090	90	55	2.8	8	0.310	5	50	2500

FINISH AVAILABLE : S/C, POLISHED & LACQUERED BRASS/CP/SNP/SCP/ANTIQU BRASS

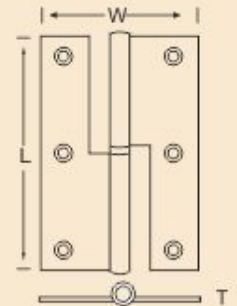

BRASS " H " HINGES WITH ROUND HEAD



TECHNICAL DATA

DPG CODE	SIZE	ITEM CODE	LENGTH	SCREW NO.	WT/ PAIR	PRS. IN INNER	PRS. IN OUTER	PRS. IN PALLET
GB2098	2"	BHIN2098050	50	6	0.040	10	500	20000
GB2099	2.5"	BHIN2099065	65	6	0.060	10	250	12500
GB2100	3"	BHIN2100075	75	6	0.070	10	250	10000
GB2101	3.5"	BHIN2101090	90	6	0.080	10	200	8000

FINISH AVAILABLE : S/C, POLISHED & LACQUERED BRASS/CP/SNP/SCP/ANTIQU BRASS

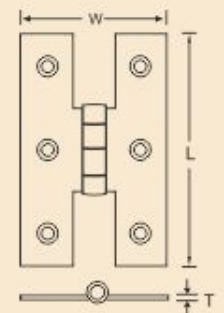

BRASS BUTT HINGES WITH TWO BALL BEARING AND FINIAL HEAD (S.S. PIN)



TECHNICAL DATA

DPG CODE	SIZE	ITEM CODE	LENGTH	WIDTH	THICKNESS	SCREW NO.	WT/ PAIR	PRS. IN INNER	PRS. IN OUTER	PRS. IN PALLET
GB1601	4"	BHIN1601100	100	75	3.0	8	0.540	5	40	1200
GB1602	4"	BHIN1602100	100	90	3.0	8	0.620	5	30	1200

FINISH AVAILABLE : S/C, POLISHED & LACQUERED BRASS/CP/SNP/SCP/ANTIQUE BRASS

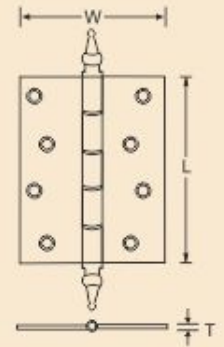

BRASS BUTT HINGES WITH ACRON TIP (S.S. PIN)



TECHNICAL DATA

DPG CODE	SIZE	ITEM CODE	LENGTH	WIDTH	THICKNESS	SCREW NO.	WT/ PAIR	PRS. IN INNER	PRS. IN OUTER	PRS. IN PALLET
GB2201	3"	BHIN2201080	80	60	2.5	6	0.270	5	60	2400

FINISH AVAILABLE : S/C, POLISHED & LACQUERED BRASS/CP/SNP/SCP/ANTIQUE BRASS

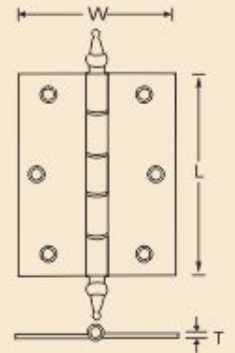

BRASS BUTT HINGES WITH TWO BALL BEARING AND DOUBLE SECURITY PIN



TECHNICAL DATA

DPG CODE	SIZE	ITEM CODE	LENGTH	WIDTH	THICKNESS	SCREW NO.	WT/ PAIR	PRS. IN INNER	PRS. IN OUTER	PRS. IN PALLET
GB1701	3.5"	BHIN1701090	90	90	2.8	8	0.540	5	40	1440

FINISH AVAILABLE : S/C, POLISHED & LACQUERED BRASS/CP/SNP/SCP/ANTIQUE BRASS

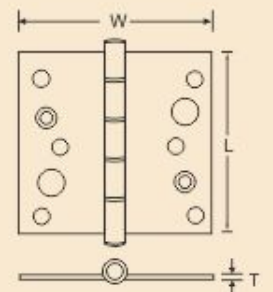

BRASS BUTT HINGES WITH RADIUS CORNER, ROUND HEAD



TECHNICAL DATA

DPG CODE	SIZE	ITEM CODE	LENGTH	WIDTH	THICKNESS	SCREW NO.	WT/ PAIR	PRS. IN INNER	PRS. IN OUTER	PRS. IN PALLET
GB2302	3"	BHIN2302080	80	80	3.0	8	0.450	5	40	1600

FINISH AVAILABLE : S/C, POLISHED & LACQUERED BRASS/CP/SNP/SCP/ANTIQUE BRASS

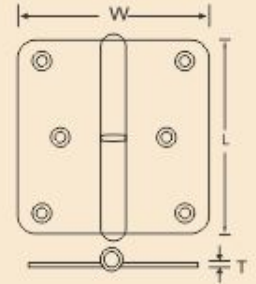

BRASS CRANKED HINGES WITH TWO BALL BEARING, BUTTON TIP HEAD (S.S. PIN)



TECHNICAL DATA

DPG CODE	SIZE	ITEM CODE	LENGTH	WIDTH	THICKNESS	SCREW NO.	WT/ PAIR	PRS. IN INNER	PRS. IN OUTER	PRS. IN PALLET
GB2400	2.5"	BHIN2400063	63	58	1.7	6	0.195	10	100	4000
GB2401	4"	BHIN2401100	100	80	3.0	8	0.660	5	30	1200

FINISH AVAILABLE : S/C, POLISHED & LACQUERED BRASS/CP/SNP/SCP/ANTIQUE BRASS

NOTE : 2.5" IS WITHOUT BALL BEARING

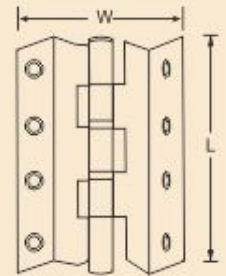

BRASS COUNTER FLAP HINGE



TECHNICAL DATA

DPG CODE	SIZE	ITEM CODE	LENGTH	WIDTH	THICK.	SCREW NO.	WT/ PAIR	PRS. IN INNER	PRS. IN OUTER	PRS. IN PALLET
GB3152	1.25"X3"	BHIN3152032	32	77	3	7	0.140	10	100	5000
GB3152	1.5"X4"	BHIN3152038	37	103	3	7	0.230	5	80	3200

FINISH AVAILABLE : S/C, POLISHED & LACQUERED BRASS/CP/SNP/SCP/ANTIQUE BRASS

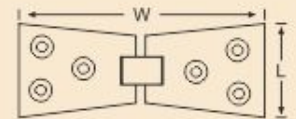

BRASS PARLIAMENT HINGES



TECHNICAL DATA

DPG CODE	SIZE	ITEM CODE	LENGTH	WIDTH	THICKNESS	SCREW NO.	WT/ PC	PCS. IN INNER	PCS. IN OUTER	PCS. IN PALLET
GB3210	4*X2"	BHIN3210050	100x50	100	3.0	10	0.460	5	25	1500
GB3210	4*X3"	BHIN3210075	100x75	125	3.0	10	0.600	5	20	1200
GB3210	4*X4"	BHIN3210100	100x100	150	3.0	10	0.726	2	12	840
GB3210	4*X5"	BHIN3210125	100x125	175	3.0	10	0.834	2	12	840
GB3210	4*X6"	BHIN3210150	100x150	200	3.0	10	0.900	2	12	840

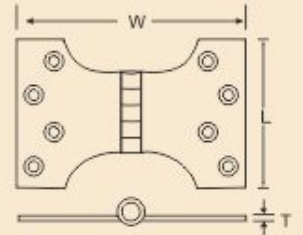

FINISH AVAILABLE : S/C, POLISHED & LACQUERED BRASS/CP/SNP/SCP/ANTIQUE BRASS

BRASS PARLIAMENT HINGES



TECHNICAL DATA

DPG CODE	SIZE	ITEM CODE	LENGTH	WIDTH	THICKNESS	SCREW NO.	WT/ PCS	PCS. IN INNER	PCS. IN OUTER	PCS. IN PALLET
GB3210A	4*X2"	BHIN3211050	100x50	100	4.0	10	0.640	4	20	1000
GB3210A	4*X3"	BHIN3211075	100x75	125	4.0	10	0.800	4	16	800
GB3210A	4*X4"	BHIN3211100	100x100	150	4.0	10	0.968	4	4	800
GB3210A	4*X5"	BHIN3211125	100x125	175	4.0	10	1.112	4	4	640
GB3210A	4*X6"	BHIN3211150	100x150	200	4.0	10	1.184	4	4	640

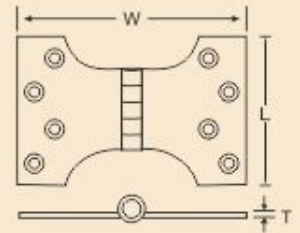

FINISH AVAILABLE : S/C, POLISHED & LACQUERED BRASS/CP/SNP/SCP/ANTIQUE BRASS

BRASS CONTINUOUS PIANO HINGES UNCRANKED KNUCKLE, FLUSH PIN



TECHNICAL DATA

DPG CODE	SIZE	ITEM CODE	LENGTH	WIDTH	THICKNESS	PRS. IN INNER	PRS. IN OUTER
GB0101	UP TO 7"	BHIN0101XXX	Up to 2000	25,32,50	0.6	10	50

FINISH AVAILABLE : S/C, POLISHED & LACQUERED BRASS/CP/SNP/SCP/ANTIQUE BRASS



BRASS REFLUX HINGE



TECHNICAL DATA

DPG CODE	SIZE	ITEM CODE	LENGTH	SCREW NO.	WT/ SET	SET. IN INNER	SET. IN OUTER	SET. IN PALLET
GB1811	2.5"	BHIN1811065	65	6	0.065	10	200	11200

FINISH AVAILABLE : S/C, POLISHED & LACQUERED BRASS/CP/SNP/SCP/ANTIQU BRASS

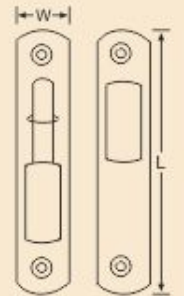

BRASS SNAKE HINGE



TECHNICAL DATA

DPG CODE	SIZE	ITEM CODE	LENGTH	WIDTH	THICKNESS	SCREW NO.	WT/ PAIR	PRS. IN INNER	PRS. IN OUTER	PRS. IN PALLET
GB2451	2.5"	BHIN2451063	65	50	3.0	6	0.080	10	200	11200

FINISH AVAILABLE : S/C, POLISHED & LACQUERED BRASS/CP/SNP/SCP/ANTIQU BRASS

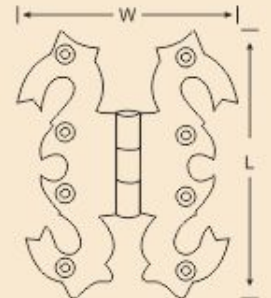

EXTRA MALLEABLE ANTIQUE BUTTERFLY HINGE



TECHNICAL DATA

DPG CODE	ITEM CODE	SIZE	LENGTH	WIDTH	THICKNESS	SCREW NO.	WT/ PAIR	PRS. IN INNER	PRS. IN OUTER	PRS. IN PALLET
MG1302	MHIN1302075	3"	71	48	2.5	5	0.122	10	100	6000

FINISH AVAILABLE : SC, BZP, ZYP, EB, EXB, EXW, CP, ANTIQU BRASS, DUROSIL

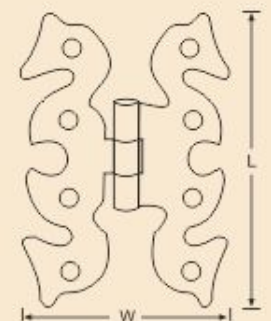

BLACK ANTIQUE BUTTERFLY HINGE



TECHNICAL DATA

DPG CODE	ITEM CODE	SIZE	LENGTH	WIDTH	SCREW NO.	WT/ PAIR	PAIR IN INNER	PAIR IN OUTER	PAIR IN PALLET
G1302	CHIN1302070	3"	70	46	6	0.116	20	320	6080

FINISH AVAILABLE : EXB, DUROSIL, GALVORITE, PEWTER

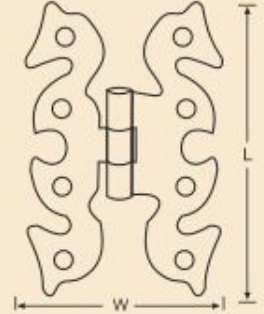

CAST BUTT HINGE

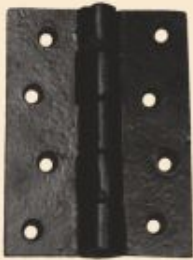

TECHNICAL DATA

DPG CODE	ITEM CODE	SIZE	LENGTH	WIDTH	SCREW NO.	WT/ PAIR	PRS. IN INNER	PRS. IN OUTER	PRS. IN PALLET
G1297	CHIN1297050	2"	51	43	8	0.146	20	120	5400
G1298	CHIN1298065	2.5"	65	46	8	0.200	20	80	3600
G1299	CHIN1299075	3"	76	52	8	0.290	20	60	2880
G1301	CHIN1301100	4"	103	58	8	0.400	10	40	1800

FINISH AVAILABLE : SC, EXB, GALVORITE, PEWTER

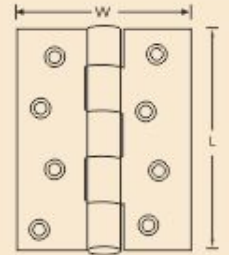

BLACK ANTIQUE UNEQUAL HINGE



TECHNICAL DATA

DPG CODE	ITEM CODE	SIZE	LENGTH	WIDTH	SCREW NO.	WT/ PAIR	PRS. IN INNER	PRS. IN OUTER	PRS. IN PALLET
G0206	CHIN0206090	3.5"	105	86	7	0.302	10	50	2400

FINISH AVAILABLE : EXB, GALVORITE, PEWTER

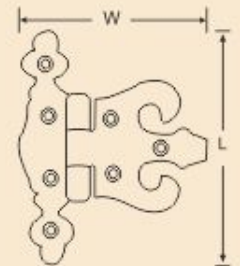

121A : MILD STEEL LIGHT TEE HINGE UNCRANKED KNUCKLE, FIXED PIN



TECHNICAL DATA

ITEM CODE	SIZE	LENGTH	WIDTH	THICKNESS	SCREW NO.	WT/ PAIR	PRS. IN INNER	PRS. IN OUTER	PRS. IN PALLET
MHINO119075	3"	79	60	1.2	6	0.062	10	200	10000
MHINO119100	4"	104	67	1.2	6	0.089	10	200	9000
MHINO119150	6"	151	70	1.4	6	0.147	10	150	4800
MHINO119200	8"	201	80	1.4	6	0.184	10	100	4000
MHINO119225	9"	227	80	1.4	6	0.200	10	100	3200
MHINO119250	10"	253	80	1.4	6	0.216	10	80	3120
MHINO119300	12"	303	89	1.6	6	0.356	10	50	1750

FINISH AVAILABLE : SC, BZP, ZYP, JAPD, EXB, DUROSIL, GALVORITE, HSG
NOTE : ALSO AVAILABLE WITH BRASS OR STAINLESS STEEL PIN.

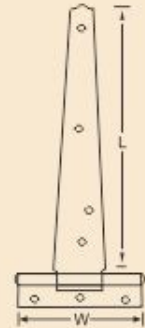

121AL : MILD STEEL LIGHT HINGE UNCRANKED KNUCKEL FIXED PIN (ECO)



TECHNICAL DATA

ITEM CODE	SIZE	LENGTH	WIDTH	THICKNESS	SCREW NO.	WT/ PAIR	PRS. IN INNER	PRS. IN OUTER	PRS. IN PALLET
MHIN119L075	3"	79	60	1.1	6	0.055	10	200	10000
MHIN119L100	4"	104	67	1.1	6	0.078	10	200	9000
MHIN119L150	6"	151	70	1.1	6	0.130	10	150	4800
MHIN119L200	8"	201	80	1.2	6	0.150	10	100	4000
MHIN119L225	9"	227	80	1.2	6	0.155	10	100	3200
MHIN119L250	10"	253	80	1.2	6	0.164	10	80	3120
MHIN119L300	12"	303	89	1.3	6	0.254	10	50	1750

FINISH AVAILABLE : SC, BZP, ZYP, JAPD, EXB, DUROSIL, GALVORITE, HSG
NOTE : ALSO AVAILABLE WITH BRASS OR STAINLESS STEEL PIN.

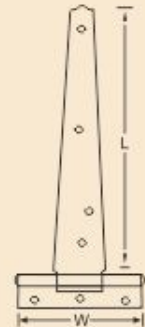

119P : MILD STEEL LIGHT TEE PREMIUM UNCRANKED KNUCKLE, FIXED PIN



TECHNICAL DATA

ITEM CODE	SIZE	LENGTH	WIDTH	THICKNESS	SCREW NO.	WT/ PAIR	PRS. IN INNER	PRS. IN OUTER	PRS. IN PALLET
MHINP119100	4"	100	66	1.6	6	0.100	10	200	9000
MHINP119150	6"	153	70	1.6	6	0.165	10	120	4800
MHINP119200	8"	200	80	1.6	6	0.230	10	80	4000
MHINP119225	9"	231	76	1.6	6	0.260	10	80	2560
MHINP119250	10"	248	76	1.6	6	0.284	10	60	2340

FINISH AVAILABLE : SC, BZP, ZYP, JAPD, EXB, DUROSIL, GALVORITE, HSG
NOTE : ALSO AVAILABLE WITH BRASS OR STAINLESS STEEL PIN.

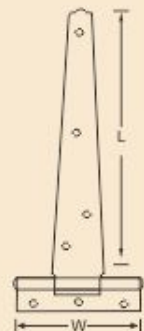

121M : MILD STEEL MEDIUM TEE HINGE UNCRANKED KNUCKLE, FIXED PIN



TECHNICAL DATA

ITEM CODE	SIZE	LENGTH	WIDTH	THICKNESS	SCREW NO.	WT/ PAIR	PRS. IN INNER	PRS. IN OUTER	PRS. IN PALLET
MHIN0120250	10"	255	89	1.85	8	0.350	5	50	1950
MHIN0120300	12"	305	100	1.85	8	0.430	5	40	1440
MHIN0120350	14"	355	115	1.85	8	0.570	5	35	980
MHIN0120375	15"	380	115	1.85	8	0.610	5	30	1020
MHIN0120400	16"	405	125	2.20	10	0.864	5	20	720
MHIN0120450	18"	455	130	2.20	10	0.968	5	20	600
MHIN0120500	20"	505	150	2.25	12	1.264	5	15	480
MHIN0120600	24"	605	150	2.25	12	1.436	5	10	360

FINISH AVAILABLE : SC, BZP, ZYP, JAPD, EXB, DUROSIL, GALVORITE, HSG
NOTE : ALSO AVAILABLE WITH BRASS OR STAINLESS STEEL PIN.



121L : MILD STEEL MEDIUM HINGE UNCRANKED KNUCKEL FIXED PIN (ECO)



TECHNICAL DATA

ITEM CODE	SIZE	LENGTH	WIDTH	THICKNESS	SCREW NO.	WT/ PAIR	PRS. IN INNER	PRS. IN OUTER	PRS. IN PALLET
MHIN120L250	10"	255	89	1.40	8	0.282	5	50	1950
MHIN120L300	12"	305	100	1.40	8	0.360	5	40	1440
MHIN120L350	14"	355	115	1.40	8	0.530	5	35	980
MHIN120L375	15"	380	115	1.40	8	0.554	5	30	1020
MHIN120L400	16"	405	125	1.80	10	0.728	5	20	720
MHIN120L450	18"	455	130	1.80	10	0.796	5	20	600
MHIN120L500	20"	505	150	1.80	12	1.070	5	15	480
MHIN120L600	24"	605	150	1.80	12	1.126	5	10	360

FINISH AVAILABLE : SC, BZP, ZYP, JAPD, EXB, DUROSIL, GALVORITE, HSG
NOTE : ALSO AVAILABLE WITH BRASS OR STAINLESS STEEL PIN.

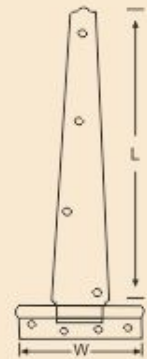

120P : MILD STEEL PREMIUM MEDIUM TEE HINGE UNCRANKED KNUCKLE, FIXED PIN



TECHNICAL DATA

ITEM CODE	SIZE	LENGTH	WIDTH	THICKNESS	SCREW NO.	WT/ PAIR	PRS. IN INNER	PRS. IN OUTER	PRS. IN PALLET
MHINP120300	12"	305	100	1.9	8	0.510	5	40	1440
MHINP120350	14"	351	114	1.9	8	0.630	5	30	1080
MHINP120375	15"	384	114	1.9	10	0.640	5	30	1020
MHINP120400	16"	410	124	2.5	10	0.960	10	10	720
MHINP120450	18"	465	140	2.5	10	1.110	10	10	600

FINISH AVAILABLE : SC, BZP, ZYP, JAPD, EXB, DUROSIL, GALVORITE, HSG
NOTE : ALSO AVAILABLE WITH BRASS OR STAINLESS STEEL PIN.



121H : MILD STEEL HEAVY TEE HINGE UNCRANKED KNUCKLE, FIXED PIN

TECHNICAL DATA

ITEM CODE	SIZE	LENGTH	WIDTH	THICKNESS	SCREW NO.	WT/ PAIR	PRS. IN INNER	PRS. IN OUTER	PRS. IN PALLET
MHIN0122100	4"	102	90	2.4	9	0.334	5	50	2000
MHIN0122150	6"	152	90	2.4	9	0.390	5	50	2000
MHIN0122200	8"	200	100	2.4	9	0.490	5	40	1600
MHIN0122250	10"	250	100	2.4	10	0.568	5	35	1260
MHIN0122300	12"	303	100	2.5	10	0.614	5	30	1200
MHIN0122350	14"	350	100	2.5	10	0.690	5	25	1000
MHIN0122400	16"	408	140	2.5	10	1.170	5	15	600
MHIN0122450	18"	452	150	3.0	12	1.185	5	5	540
MHIN0122500	20"	510	165	3.0	12	1.920	5	5	450
MHIN0122600	24"	612	165	3.0	12	2.120	5	5	320



FINISH AVAILABLE : SC, BZP, ZYP, JAPD, EXB, DUROSIL, GALVORITE, HSG
NOTE : ALSO AVAILABLE WITH BRASS OR STAINLESS STEEL PIN.

120 : MILD STEEL STRONG TEE HINGE UNCRANKED KNUCKLE, FIXED PIN

TECHNICAL DATA

ITEM CODE	SIZE	LENGTH	WIDTH	THICKNESS	SCREW NO.	WT/ PAIR	PRS. IN INNER	PRS. IN OUTER	PRS. IN PALLET
MHIN1120150	6"	155	89	2.0	8	0.312	5	50	2000
MHIN1120200	8"	205	100	2.4	10	0.454	5	40	1600
MHIN1120250	10"	255	102	2.4	10	0.510	5	35	1260
MHIN1120300	12"	303	115	2.4	10	0.650	5	30	1200
MHIN1120350	14"	356	128	2.4	10	0.880	5	20	800
MHIN1120400	16"	408	140	2.5	10	1.140	5	15	600
MHIN1120450	18"	460	150	3.0	12	1.516	5	5	450
MHIN1120500	20"	510	165	3.0	12	1.800	5	5	450
MHIN1120600	24"	617	165	3.0	12	2.140	5	5	320



FINISH AVAILABLE : SC, BZP, ZYP, JAPD, EXB, DUROSIL, GALVORITE, HSG
NOTE : ALSO AVAILABLE WITH BRASS OR STAINLESS STEEL PIN.

119 : MILD STEEL SCOTCH TEE HINGE UNCRANKED KNUCKLE, FIXED PIN

TECHNICAL DATA

ITEM CODE	SIZE	LENGTH	WIDTH	THICKNESS	SCREW NO.	WT/ PAIR	PRS. IN INNER	PRS. IN OUTER	PRS. IN PALLET
MHIN1119100	4"	100	83	2.5	10	0.320	5	50	2000
MHIN1119150	6"	152	90	2.5	10	0.430	5	40	1600
MHIN1119200	8"	200	102	3.0	10	0.660	5	30	990
MHIN1119250	10"	258	115	3.0	12	0.900	5	20	720
MHIN1119300	12"	303	126	3.0	12	1.100	5	5	600
MHIN1119350	14"	357	140	3.4	12	1.674	5	5	400
MHIN1119400	16"	406	145	3.4	12	1.720	5	5	400

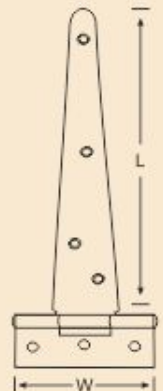

FINISH AVAILABLE : SC, BZP, ZYP, JAPD, EXB, DUROSIL, GALVORITE, HSG
NOTE : ALSO AVAILABLE WITH BRASS OR STAINLESS STEEL PIN.

868 : MILD STEEL HEAVY SCOTCH TEE HINGE UNCRANKED KNUCKLE, FIXED PIN

TECHNICAL DATA



ITEM CODE	SIZE	LENGTH	WIDTH	THICKNESS	SCREW NO.	WT/ PAIR	PRS. IN INNER	PRS. IN OUTER	PRS. IN PALLET
MHIN0868100	4"	102	90	2.5	8	0.334	5	50	2000
MHIN0868150	6"	152	90	2.5	8	0.390	5	50	2000
MHIN0868200	8"	200	100	2.5	8	0.486	5	40	1600
MHIN0868250	10"	250	100	2.5	10	0.568	5	35	1260
MHIN0868300	12"	303	100	2.8	10	0.768	5	25	1000
MHIN0868350	14"	350	145	3.0	12	1.490	5	10	450
MHIN0868375	15"	382	145	3.0	12	1.600	2	10	360
MHIN0868400	16"	405	145	3.0	12	1.622	2	10	360
MHIN0868450	18"	455	177	3.15	12	2.010	2	10	320
MHIN0868500	20"	505	177	3.0	12	2.460	2	8	320
MHIN0868600	24"	610	177	3.3	12	2.726	2	6	240



FINISH AVAILABLE : SC, BZP, ZYP, JAPD, EXB, DUROSIL, GALVORITE, HSG
NOTE : ALSO AVAILABLE WITH BRASS OR STAINLESS STEEL PIN

867 : MILD STEEL EXTRA STRONG WEIGHTY TEE HINGE UNCRANKED KNUCKLE, FIXED PIN



TECHNICAL DATA

ITEM CODE	SIZE	LENGTH	WIDTH	THICKNESS	SCREW NO.	WT/ PAIR	PRS. IN INNER	PRS. IN OUTER	PRS. IN PALLET
MHIN0867100	4"	101	90	2.8	8	0.410	5	50	1500
MHIN0867150	6"	150	90	2.8	8	0.500	5	40	1200
MHIN0867200	8"	200	100	3.0	10	0.650	5	30	900
MHIN0867250	10"	250	115	3.0	10	0.794	5	25	900
MHIN0867300	12"	302	127	3.0	10	0.982	5	20	800

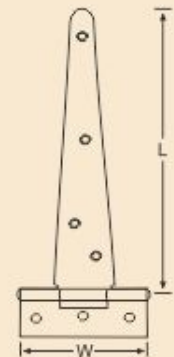

FINISH AVAILABLE : SC, BZP, ZYP, JAPD, EXB, DUROSIL, GALVORITE, HSG
NOTE : ALSO AVAILABLE WITH BRASS OR STAINLESS STEEL PIN.

909 : MILD STEEL TEE HINGE UNCRANKED KNUCKLED FIXED PIN



TECHNICAL DATA

ITEM CODE	SIZE	LENGTH	WIDTH	THICKNESS	SCREW NO.	WT/ PAIR	PRS. IN INNER	PRS. IN OUTER	PRS. IN PALLET
MHIN0909100	4"	100	67	1.20	6	0.089	10	200	9000
MHIN0909150	6"	150	70	1.40	6	0.147	10	150	4800
MHIN0909225	9"	222	80	1.40	6	0.200	10	100	3200
MHIN0909300	12"	300	100	1.85	8	0.430	5	40	1440
MHIN0909375	15"	375	115	1.85	8	0.601	5	30	1020
MHIN0909400	16"	400	125	2.20	10	0.854	5	20	720
MHIN0909450	18"	450	130	2.20	10	1.002	5	20	600

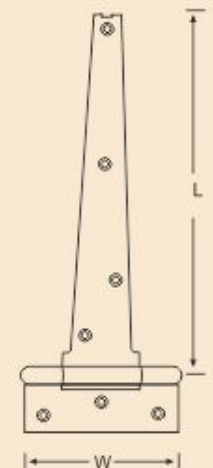

FINISH AVAILABLE : SC, BZP, ZYP, JAPD, EXB, DUROSIL, GALVORITE, HSG
NOTE : ALSO AVAILABLE WITH BRASS OR STAINLESS STEEL PIN.

910 : MILD STEEL GRADED TEE HINGE



TECHNICAL DATA

ITEM CODE	SIZE	LENGTH	WIDTH	THICKNESS	SCREW NO.	WT/ PAIR	PRS. IN INNER	PRS. IN OUTER	PRS. IN PALLET
MHIN0910100	4"	102	80	2.0	8	0.240	5	60	2700
MHIN0910150	6"	150	90	2.2	8	0.340	5	40	2000
MHIN0910225	9"	230	100	2.5	10	0.586	5	30	1080
MHIN0910250	10"	250	100	2.5	10	0.546	5	30	1080
MHIN0910300	12"	300	120	2.5	12	0.776	5	20	800
MHIN0910375	15"	375	140	3.0	12	1.278	5	5	500
MHIN0910450	18"	450	170	3.0	12	1.864	5	5	350
MHIN0910600	24"	600	200	3.0	12	2.986	2	2	200

FINISH AVAILABLE : SC, BZP, ZYP, JAPD, EXB, DUROSIL, GALVORITE, HSG
NOTE : ALSO AVAILABLE WITH BRASS OR STAINLESS STEEL PIN



950 : MILD STEEL STRAP HINGE UNCRANKED KNUCKLE



TECHNICAL DATA

ITEM CODE	SIZE	LENGTH	WIDTH	THICKNESS	SCREW NO.	WT/ PAIR	PRS. IN INNER	PRS. IN OUTER	PRS. IN PALLET
MHIN0950100	4"	102	35	1.5	6	0.121	10	150	5400
MHIN0950150	6"	150	44	1.9	8	0.310	10	70	2520
MHIN0950200	8"	205	44	2.0	8	0.402	5	50	2000

FINISH AVAILABLE : SC, BZP, ZYP, JAPD, EXB, DUROSIL, HSG
NOTE : ALSO AVAILABLE WITH BRASS OR STAINLESS STEEL PIN

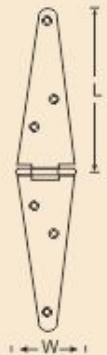

30 : MILD STEEL STRAP HINGE UNCRANKED KNUCKLE (MEDIUM WEIGHT)



TECHNICAL DATA

ITEM CODE	SIZE	LENGTH	WIDTH	THICKNESS	SCREW NO.	WT/ PAIR	PRS. IN INNER	PRS. IN OUTER	PRS. IN PALLET
MHIN0030250	10"	259	63	2.6	10	0.938	5	20	720
MHIN0030300	12"	305	63	2.8	10	1.236	5	10	600

FINISH AVAILABLE : SC, BZP, ZYP, JAPD, EXB, DUROSIL, HSG
NOTE : ALSO AVAILABLE WITH BRASS OR STAINLESS STEEL PIN

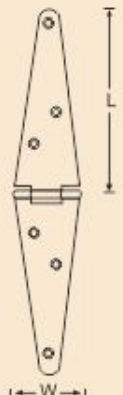

234 : MILD STEEL GATE HOLD BACK HINGE / PENTURE DE GONDS (FRENCH SPECIFICATION)



TECHNICAL DATA

ITEM CODE	SIZE	LENGTH	WIDTH	THICKNESS	SCREW NO.	WT/ PAIR	PRS. IN INNER	PRS. IN OUTER	PRS. IN PALLET
MGFI0234300	12"	300	112	4.0	10	0.520	10	40	1600
MGFI0234400	16"	400	112	4.0	10	0.620	10	30	1200
MGFI0234500	20"	500	112	4.0	10	0.700	10	30	1080
MGFI0234600	24"	600	112	4.0	10	0.800	5	25	900

FINISH AVAILABLE : SC, BZP, JAPD, EXB, DUROSIL, HSG

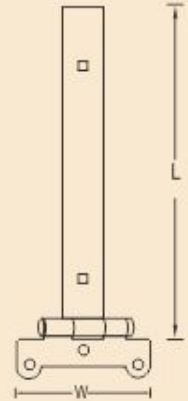

1055 : MILD STEEL HOOK AND BAND HINGE (STRAIGHT)



TECHNICAL DATA

ITEM CODE	SIZE	LENGTH	WIDTH	THICKNESS	SCREW NO.	WT/ PAIR	PRS. IN INNER	PRS. IN OUTER	PRS. IN PALLET
MGFI1055250	10"	254	38	4	12	1.381	2	14	630
MGFI1055300	12"	305	38	4	12	1.552	2	12	540
MGFI1055350	14"	355	45	4	12	1.860	2	8	400
MGFI1055400	16"	407	45	4	12	2.036	2	8	384
MGFI1055450	18"	458	48	4.5	12	2.848	1	6	270
MGFI1055500	20"	508	48	4.5	12	3.028	1	6	192
MGFI1055600	24"	610	48	4.8	12	3.664	1	3	162
MGFI1055750	30"	760	57	5	12	5.428	1	3	120
MGFI1055900	36"	914	63	5	12	6.700	1	2	84
MGFI1055I42	42"	1065	69	5	12	8.300	1	1	60
MGFI1055I48	48"	1220	69	5	12	10.700	1	1	60

FINISH AVAILABLE : SC, BZP, JAPD, EXB, DUROSIL, HSG, GALVORITE

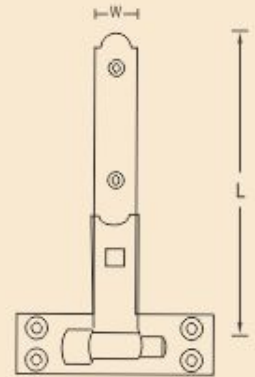

1055E : MILD STEEL HOOK AND BAND HINGE (STRAIGHT) ECO



TECHNICAL DATA

ITEM CODE	SIZE	LENGTH	WIDTH	THICKNESS	SCREW NO.	WT/ PAIR	PRS. IN INNER	PRS. IN OUTER	PRS. IN PALLET
MGFI1053250	10"	254	35	3.5	12	1.130	2	14	630
MGFI1053300	12"	305	35	3.5	12	1.220	2	12	540
MGFI1053350	14"	355	35	3.5	12	1.334	2	8	400
MGFI1053400	16"	407	35	3.5	12	1.390	2	8	384
MGFI1053450	18"	458	40	4.0	12	2.176	1	6	270
MGFI1053500	20"	508	40	4.0	12	2.308	1	6	192
MGFI1053600	24"	610	40	4.0	12	2.560	1	3	162

FINISH AVAILABLE : SC, BZP, JAPD, EXB, DUROSIL, HSG, GALVORITE



128 : MILD STEEL PREMIUM HOOK AND BAND HINGE (STRAIGHT)



TECHNICAL DATA

ITEM CODE	SIZE	LENGTH	WIDTH	THICKNESS	SCREW NO.	WT/ PAIR	PRS. IN INNER	PRS. IN OUTER	PRS. IN PALLET
MGFI0128250	10"	255	38	4.8	12	1.475	2	14	630
MGFI0128300	12"	305	38	4.8	12	1.710	2	12	540
MGFI0128350	14"	357	38	4.8	12	1.800	2	8	400
MGFI0128400	16"	404	38	4.8	12	1.860	2	8	384
MGFI0128450	18"	460	50	4.8	12	3.160	1	6	270
MGFI0128500	20"	512	50	4.8	12	3.280	1	6	192
MGFI0128600	24"	610	56	4.8	12	4.580	1	3	162
MGFI0128750	30"	761	56	5.4	12	5.160	1	3	120
MGFI0128900	36"	915	56	5.4	12	6.300	1	2	84

FINISH AVAILABLE : SC, BZP, JAPD, EXB, DUROSIL, HSG, GALVORITE

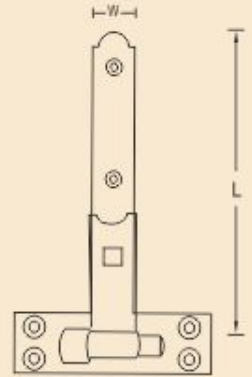

1056 : MILD STEEL HOOK AND BAND HINGE (CRANKED)



TECHNICAL DATA

ITEM CODE	SIZE	LENGTH	WIDTH	THICKNESS	SCREW NO.	WT/ PAIR	PRS. IN INNER	PRS. IN OUTER	PRS. IN PALLET
MGFI1056250	10"	254	38	4	12	1.381	2	14	630
MGFI1056300	12"	305	38	4	12	1.552	2	12	540
MGFI1056350	14"	355	45	4	12	1.860	2	8	400
MGFI1056400	16"	407	45	4	12	2.036	2	8	384
MGFI1056450	18"	458	48	4.5	12	2.848	1	6	270
MGFI1056500	20"	508	48	4.5	12	3.028	1	6	192
MGFI1056600	24"	610	48	4.8	12	3.664	1	3	162
MGFI1056750	30"	760	57	5	12	5.428	1	3	120
MGFI1056900	36"	914	63	5	12	6.700	1	2	84
MGFI1056I42	42"	1065	69	5	12	8.300	1	1	60
MGFI1056I48	48"	1220	69	5	12	10.700	1	1	60

FINISH AVAILABLE : SC, BZP, JAPD, EXB, DUROSIL, HSG, GALVORITE

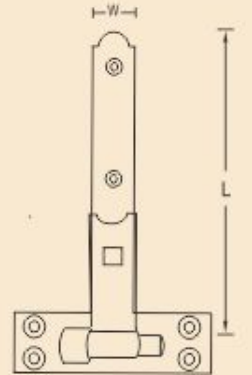

1056E : MILD STEEL HOOK AND BAND HINGE (CRANKED) ECO



TECHNICAL DATA

ITEM CODE	SIZE	LENGTH	WIDTH	THICKNESS	SCREW NO.	WT/ PAIR	PRS. IN INNER	PRS. IN OUTER	PRS. IN PALLET
MGFI1054250	10"	254	35	3.5	12	1.130	2	14	630
MGFI1054300	12"	305	35	3.5	12	1.220	2	12	540
MGFI1054350	14"	355	35	3.5	12	1.334	2	8	400
MGFI1054400	16"	407	35	3.5	12	1.390	2	8	384
MGFI1054450	18"	458	40	4.0	12	2.176	1	6	270
MGFI1054500	20"	508	40	4.0	12	2.308	1	6	192
MGFI1054600	24"	610	40	4.0	12	2.560	1	3	162

FINISH AVAILABLE : SC, BZP, JAPD, EXB, DUROSIL, HSG, GALVORITE

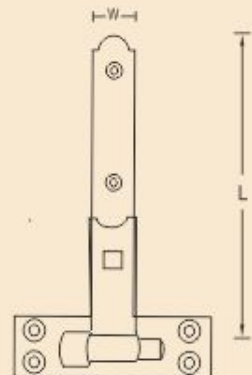

130 : MILD STEEL PREMIUM HOOK AND BAND HINGE (CRANKED)



TECHNICAL DATA

ITEM CODE	SIZE	LENGTH	WIDTH	THICKNESS	SCREW NO.	WT/ PAIR	PRS. IN INNER	PRS. IN OUTER	PRS. IN PALLET
MGF10130250	10"	255	38	4.8	12	1.475	2	14	630
MGF10130300	12"	305	38	4.8	12	1.710	2	12	540
MGF10130350	14"	357	38	4.8	12	1.800	2	8	400
MGF10130400	16"	404	38	4.8	12	1.860	2	8	384
MGF10130450	18"	460	50	4.8	12	3.160	1	6	270
MGF10130500	20"	512	50	4.8	12	3.280	1	6	192
MGF10130600	24"	610	56	4.8	12	4.580	1	3	162
MGF10130750	30"	761	56	5.4	12	5.160	1	3	120
MGF10130900	36"	915	56	5.4	12	6.300	1	2	84

FINISH AVAILABLE : SC, BZP, JAPD, EXB, DUROSIL, HSG, GALVORITE

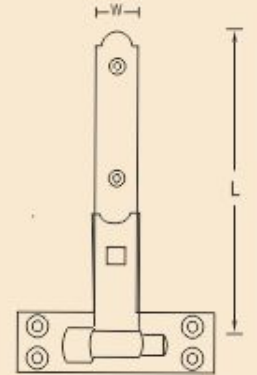

1055L : MILD STEEL LIGHT HOOK AND BAND HINGE (STRAIGHT)



TECHNICAL DATA

ITEM CODE	SIZE	LENGTH	WIDTH	THICKNESS	SCREW NO.	WT/ PAIR	PRS. IN INNER	PRS. IN OUTER	PRS. IN PALLET
MGF1053250	10"	250	38	3.0	10	1.100	2	14	630
MGF1053300	12"	300	38	3.0	12	1.200	2	14	630
MGF1053350	14"	350	45	3.0	12	1.550	2	10	500
MGF1053400	16"	400	45	3.0	12	1.620	2	10	460

FINISH AVAILABLE : SC, BZP, JAPD, EXB, DUROSIL, HSG, GALVORITE

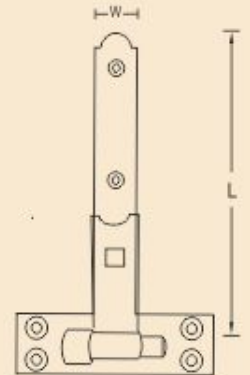

1056L : MILD STEEL LIGHT HOOK AND BAND HINGE (CRANKED)



TECHNICAL DATA

ITEM CODE	SIZE	LENGTH	WIDTH	THICKNESS	SCREW NO.	WT/ PAIR	PRS. IN INNER	PRS. IN OUTER	PRS. IN PALLET
MGF1054250	10"	250	38	3.0	10	1.100	2	14	630
MGF1054300	12"	300	38	3.0	12	1.200	2	14	630
MGF1054350	14"	350	45	3.0	12	1.550	2	10	500
MGF1054400	16"	400	45	3.0	12	1.620	2	10	460

FINISH AVAILABLE : SC, BZP, JAPD, EXB, DUROSIL, HSG, GALVORITE

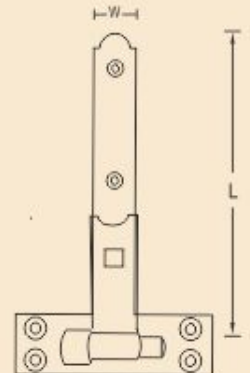

1057 : MILD STEEL ADJUSTABLE HOOK AND BAND HINGE



TECHNICAL DATA

ITEM CODE	SIZE	LENGTH	WIDTH	THICKNESS	SCREW NO.	WT/ PAIR	PRS. IN INNER	PRS. IN OUTER	PRS. IN PALLET
MGFI1057300	12"	300	45	4.0	12	3.000	1	4	260
MGFI1057450	18"	450	50	4.5	12	4.360	1	4	160
MGFI1057600	24"	600	50	5.0	12	5.040	1	3	162
MGFI1057750	30"	750	57	5.0	12	6.048	1	2	120
MGFI1057900	36"	900	63	5.0	12	7.552	1	2	70

FINISH AVAILABLE : SC, BZP, JAPD, EXB, DUROSIL, HSG, GALVORITE



499 : MILD STEEL REVERSIBLE HINGE WITH CAST IRON CUP



TECHNICAL DATA

ITEM CODE	SIZE	LENGTH	WIDTH	THICKNESS	SCREW NO.	WT/ PAIR	PRS. IN INNER	PRS. IN OUTER	PRS. IN PALLET
MGFI0499250	10"	254	38	4.0	12	1.644	2	14	420
MGFI0499300	12"	305	38	4.0	12	1.804	2	12	360
MGFI0499350	14"	355	45	4.0	12	2.200	2	8	320
MGFI0499400	16"	407	45	4.0	12	2.364	2	8	320
MGFI0499450	18"	458	48	4.5	12	3.124	1	6	270
MGFI0499500	20"	508	48	4.5	12	3.424	1	6	192
MGFI0499600	24"	610	48	4.8	12	3.868	1	3	162
MGFI0499750	30"	760	57	5.0	12	5.260	1	3	120
MGFI0499900	36"	914	63	5.0	12	6.684	1	2	84

FINISH AVAILABLE : SC, BZP, JAPD, EXB, DUROSIL, HSG, GALVORITE



499LW : MILD STEEL LIGHT WEIGHT REVERSIBLE HINGE WITH CAST IRON CUP



TECHNICAL DATA

ITEM CODE	SIZE	LENGTH	WIDTH	THICKNESS	SCREW NO.	WT/ PAIR	PRS. IN INNER	PRS. IN OUTER	PRS. IN PALLET
MGFI0498300	12"	305	38	3.0	12	1.682	2	10	540
MGFI0498350	14"	355	43	3.0	12	1.704	2	10	500
MGFI0498400	16"	407	43	3.0	12	1.832	2	10	460
MGFI0498450	18"	458	43	3.0	12	1.904	2	10	360
MGFI0498500	20"	508	43	3.0	12	2.142	2	8	320
MGFI0498600	24"	610	43	3.0	12	2.570	2	8	288

FINISH AVAILABLE : SC, BZP, JAPD, EXB, DUROSIL, HSG, GALVORITE



1056C/D : MILD STEEL HOOK AND BAND (DECORATIVE SQUARE TAIL)

TECHNICAL DATA

ITEM CODE	SIZE	LENGTH	WIDTH	THICKNESS	SCREW NO.	WT/ PAIR	PRS. IN INNER	PRS. IN OUTER	PRS. IN PALLET
MGF1059250	10"	260	40	3.0	12	0.854	2	14	700
MGF1059300	12"	310	40	3.0	12	0.950	2	12	540
MGF1059400	16"	390	40	3.0	12	1.124	2	10	500
MGF1059500	20"	515	40	3.0	12	1.310	2	10	480
MGF1059600	24"	615	40	4.0	12	1.972	2	10	300
MGF1059750	30"	750	40	4.0	12	2.282	2	10	300

FINISH AVAILABLE : SC, BZP, JAPD, EXB, DUROSIL, HSG, GALVORITE
(ALSO AVAILABLE 1055D DECORATIVE)

7182 : MILD STEEL STATE PATTERN BAND

TECHNICAL DATA

ITEM CODE	SIZE	LENGTH	WIDTH	THICKNESS	WT/ PCS	PCS. IN INNER	PCS. IN OUTER	PCS. IN PALLET
MGF17182450	18"	450	57	5.0	1.270	4	12	504
MGF17182500	20"	500	57	5.0	1.382	4	12	504

FINISH AVAILABLE : SC, BZP, JAPD, EXB, DUROSIL, HSG, GALVORITE

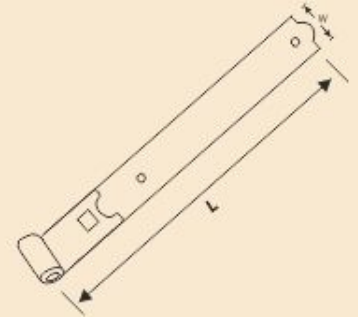
1061 : MILD STEEL SHORT HINGES

TECHNICAL DATA

ITEM CODE	SIZE	LENGTH	WIDTH	THICKNESS	WT/ PCS	PCS. IN INNER	PCS. IN OUTER	PCS. IN PALLET
MGF1061150	6"	151	40	8.0	0.518	10	30	1260
MGF1061300	12"	308	40	8.0	0.908	10	20	800
MGF1061450	18"	460	40	8.0	1.211	4	16	608

FINISH AVAILABLE : SC, BZP, JAPD, EXB, DUROSIL, HSG, GALVORITE

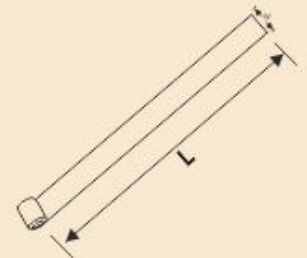

1055H : HOOK ON BACK PLATE TO SUIT HOOK & BAND



TECHNICAL DATA

ITEM CODE	SIZE	LENGTH	WIDTH	THICK.	PIN DIA	SCREW NO.	WT/ PCS	PCS. IN INNER	PCS. IN OUTER	PCS. IN PALLET
MGF1156012	10" & 12"	134	38	4.0	12	12	0.522	5	30	1200
MGF1156013	14" & 16"	134	45	4.0	13	12	0.572	5	30	1200
MGF1156016	18" & 20" & 24"	166	48	4.5	16	12	0.920	5	20	720
MGF1156019	30"	200	57	5.0	19	12	1.556	2	10	400
MGF1156020	36"	200	63	5.0	20	12	1.582	2	10	400

FINISH AVAILABLE : BZP, ARJUNA, EXB, HSG, DUROSIL

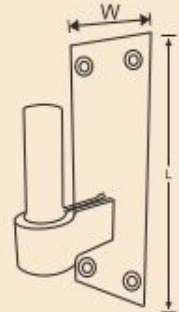

112G : HOOK ON BACK PLATE TO SUIT ADJ. BAND



TECHNICAL DATA

ITEM CODE	SIZE	LENGTH	WIDTH	THICK.	PIN DIA	SCREW NO.	WT/ PRS	PRS. IN INNER	PRS. IN OUTER	PRS. IN PALLET
MGF112G135	10", 12" & 14"	135	45	4.0	16	12	0.748	5	30	1200
MGF112G166	18" & 20" & 24"	166	50	5.0	19	12	1.062	5	20	1200
MGF112G200	30"	200	57	5.0	19	12	1.556	2	10	400

FINISH AVAILABLE : BZP, ARJUNA, EXB, HSG, DUROSIL

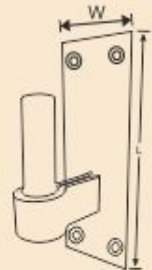

499C : CUP ONLY FOR REVERSIBLE HINGE



TECHNICAL DATA

ITEM CODE	SIZE	LENGTH	WIDTH	THICKNESS	HOLE DIA	SCREW NO.	WT/ SET	SET IN INNER	SET IN OUTER	SET IN PALLET
MGF499C012	10" & 12"	51	50	6.5-7.5	12	10	0.500	4	24	1080
MGF499C016	14" & 16"	54	53	6.5-7.5	14	10	0.616	4	24	1080
MGF499C019	18" & 20" & 24"	67	62	6.5-7.5	18	12	0.960	2	16	720
MGF499C022	30" & 36"	67	62	7.5-8.5	20	12	0.940	2	16	720

FINISH AVAILABLE : EXB, SC, GALVORITE, HSG
REMARK : SUPPLIED IN SET OF 4 PCS.

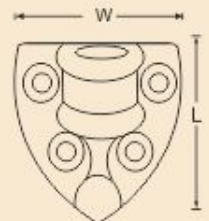

GF0251 : MILD STEEL BARREL HINGE



TECHNICAL DATA

ITEM CODE	SIZE	LENGTH	WIDTH	DIA	BOLT	WT/ SET	SET IN INNER	SET IN INNER	SET IN PALLET
MHIN0251XXX	1"	36	29	9.4	M6	0.024	50	500	30000

FINISH AVAILABLE : SC, BZP, ARJUNA, YPZP, EB, CP

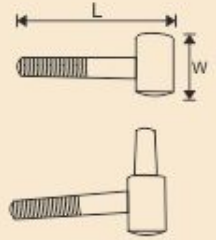

252 : MILD STEEL ADJUSTABLE HINGE



TECHNICAL DATA

ITEM CODE	LENGTH		WIDTH		THICKNESS	SHOOT DIA	SCREW NO	WT/ PCS	PCS.IN INNER	PCS.IN OUTER	PCS.IN PALLET
	L1	L2	W1	W2							
MHIN0252083	83	40	15	40	2.5	8.6	7	0.179	10	100	4000

FINISH AVAILABLE : SC, BZP, ZYP, EB, CP, GALVORITE

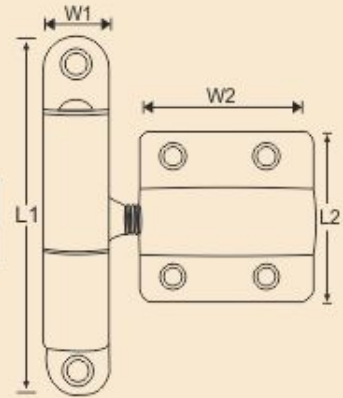

38 : MILD STEEL BULLET HINGES



TECHNICAL DATA

ITEM CODE	LENGTH	OUTAR DIA	WT/PCS	PCS IN INNER	PCS IN OUTER	PCS IN PALLET
MHIN3805010	50	10	0.030	50	1000	36000
MHIN3807012	70	12	0.060	50	400	18000
MHIN3807014	70	14	0.082	20	300	12000
MHIN3807016	70	16	0.103	20	200	9000
MHIN3807018	70	18	0.135	20	160	7200
MHIN3807020	70	20	0.170	20	140	5600
MHIN3810016	100	16	0.155	10	120	5400
MHIN3810020	100	20	0.250	10	80	4320
MHIN3810025	100	25	0.370	6	60	2520
MHIN3812030	100	30	0.650	4	32	1440

FINISH AVAILABLE : SC, ZP



BLACK ANTIQUE SPEAR HINGE



TECHNICAL DATA

DPG CODE	ITEM CODE	SIZE	LENGTH	WIDTH	SCREW NO.	WT/PCS	PCS. IN INNER	PCS. IN OUTER	PCS. IN PALLET
G0017	CHIN0017220	9"	200	106	8	0.203	10	80	3200
G0019	CHIN0019290	12"	270	112	8	0.264	10	60	3200

FINISH AVAILABLE : EXB, DUROSIL, PEWTER

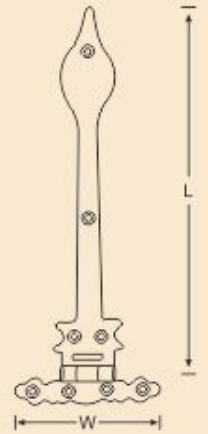

BLACK ANTIQUE ORNATE HINGE



TECHNICAL DATA

DPG CODE	ITEM CODE	SIZE	LENGTH	WIDTH	SCREW NO.	WT/PCS	PCS. IN INNER	PCS. IN OUTER	PCS. IN PALLET
G0201	CHIN0201150	6"	145	90	7	0.150	20	100	4000
G0202	CHIN0202225	9"	213	105	7	0.231	10	80	3600
G0201H	CHIN201H150	6"	142	92	7	0.158	20	100	4000
G0201EH	CHIN201E150	6"	142	92	7	0.235	20	100	3600
G0202H	CHIN202H225	9"	213	108	7	0.256	10	80	3200

FINISH AVAILABLE : EXB, DUROSIL, PEWTER

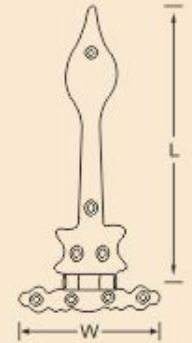

BLACK ANTIQUE ORNATE CORONET HINGE



TECHNICAL DATA

DPG CODE	ITEM CODE	SIZE	LENGTH	WIDTH	SCREW NO.	WT/PCS	PCS. IN INNER	PCS. IN OUTER	PCS. IN PALLET
G0205	CHIN0205300	12"	290	108	7	0.260	10	60	3000

FINISH AVAILABLE : EXB, DUROSIL, PEWTER

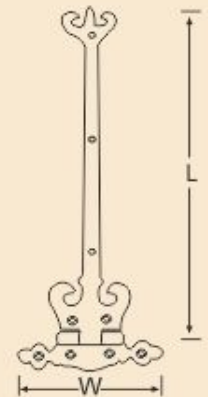

BLACK ANTIQUE HEAVY PLAIN HINGE



TECHNICAL DATA

DPG CODE	ITEM CODE	SIZE	LENGTH	WIDTH	SCREW NO.	WT/ PCS	PCS. IN INNER	PCS. IN OUTER	PCS. IN PALLET
G0208	CHIN0208375	16"	350	106	8	0.773	5	20	960
G0203H	CHIN203H225	9"	230	104	8	0.465	5	20	1600

FINISH AVAILABLE : EXB, DUROSIL, PEWTER



BLACK ANTIQUE LIGHT PLAIN HINGE



TECHNICAL DATA

DPG CODE	ITEM CODE	SIZE	LENGTH	WIDTH	SCREW NO.	WT/ PCS	PCS. IN INNER	PCS. IN OUTER	PCS. IN PALLET
G0005	CHIN0005310	12"	275	100	8	0.527	5	30	1200
G0007	CHIN0007390	16"	355	100	8	0.650	5	30	960
G0009	CHIN0009460	18"	450	100	8	0.738	5	20	960

FINISH AVAILABLE : EXB, DUROSIL, PEWTER

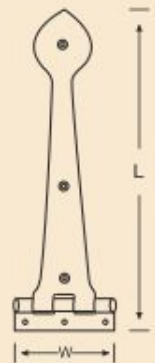

BLACK ANTIQUE FLEUR - DE - LYS HINGE



TECHNICAL DATA

DPG CODE	ITEM CODE	SIZE	LENGTH	WIDTH	SCREW NO.	WT/ PCS	PCS. IN INNER	PCS. IN OUTER	PCS. IN PALLET
G0011	CHIN0011310	12"	270	100	8	0.708	5	20	880
G0013	CHIN0013390	16"	360	100	8	0.893	5	20	720
G0015	CHIN0015460	18"	430	100	8	0.913	5	20	600

FINISH AVAILABLE : EXB, DUROSIL, PEWTER

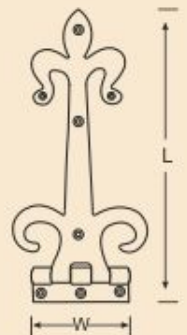

BLACK ANTIQUE CLAW HINGE



TECHNICAL DATA

DPG CODE	ITEM CODE	SIZE	LENGTH	WIDTH	SCREW NO.	WT/ PCS	PCS. IN INNER	PCS. IN OUTER	PCS. IN PALLET
G0050	CHIN0050385	16"	362	100	8	0.700	5	20	960

FINISH AVAILABLE : EXB, DUROSIL, PEWTER

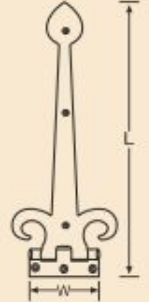

BLACK ANTIQUE FLEUR - DE - LYS CLAW HINGE FRONT



TECHNICAL DATA

DPG CODE	ITEM CODE	SIZE	LENGTH	WIDTH	SCREW NO.	WT/ PCS	PCS. IN INNER	PCS. IN OUTER	PCS. IN PALLET
G0045	CHIN0045264	11"	275	150	8	0.610	5	30	1080
G0046	CHIN0046420	17"	428	150	8	0.680	5	20	960

FINISH AVAILABLE : EXB, DUROSIL, PEWTER

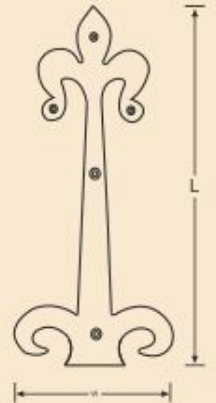

BLACK ANTIQUE LIGHT HINGE FRONT



TECHNICAL DATA

DPG CODE	ITEM CODE	SIZE	LENGTH	WIDTH	SCREW NO.	WT/ PCS	PCS. IN INNER	PCS. IN OUTER	PCS. IN PALLET
G0047	CHIN0047263	11"	270	62	8	0.230	10	80	3200

FINISH AVAILABLE : EXB, DUROSIL, PEWTER



BLACK ANTIQUE SPEAR HINGE FRONT



TECHNICAL DATA

DPG CODE	ITEM CODE	SIZE	LENGTH	WIDTH	SCREW NO.	WT/ PCS	PCS. IN INNER	PCS. IN OUTER	PCS. IN PALLET
G0042	CHIN0042350	14"	355	50	8	0.450	10	40	1400
G0044	CHIN0044420	17"	420	58	8	0.550	5	30	1200

FINISH AVAILABLE : EXB, DUROSIL, PEWTER



BLACK ANTIQUE FLEUR - DE - LYS HINGE FRONT



TECHNICAL DATA

DPG CODE	ITEM CODE	SIZE	LENGTH	WIDTH	SCREW NO.	WT/ PCS	PCS. IN INNER	PCS. IN OUTER	PCS. IN PALLET
G0020	CHIN0020406	16"	408	110	8	0.523	10	30	1200

FINISH AVAILABLE : EXB, DUROSIL, PEWTER

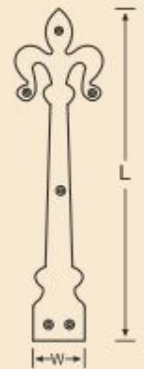

BLACK ANTIQUE SPEAR HINGE FRONT WITH CLAW



TECHNICAL DATA

DPG CODE	ITEM CODE	SIZE	LENGTH	WIDTH	SCREW NO.	WT/ PCS	PCS. IN INNER	PCS. IN OUTER	PCS. IN PALLET
G0040	CHIN0040385	16"	390	150	8	0.603	10	30	1080

FINISH AVAILABLE : EXB, DUROSIL, PEWTER





Note

A series of horizontal dotted lines for writing.