



## Hinges



Note

1. \_\_\_\_\_
2. \_\_\_\_\_
3. \_\_\_\_\_
4. \_\_\_\_\_
5. \_\_\_\_\_
6. \_\_\_\_\_
7. \_\_\_\_\_
8. \_\_\_\_\_
9. \_\_\_\_\_
10. \_\_\_\_\_
11. \_\_\_\_\_
12. \_\_\_\_\_
13. \_\_\_\_\_
14. \_\_\_\_\_
15. \_\_\_\_\_
16. \_\_\_\_\_
17. \_\_\_\_\_
18. \_\_\_\_\_
19. \_\_\_\_\_
20. \_\_\_\_\_



**GZC1215 : 3D ADJUSTABLE INVISIBLE HINGES**



**TECHNICAL DATA**

TYPE	SIZE	LENGTH	WIDTH	SCREW NO.	WT/PAIR	PRS. IN INNER	PRS. IN OUTER
MODEL-1	134X21	134	21	5	0.550	1	10
MODEL-2	159X28	159	28	5	1.140	1	10
MODEL-3	200X32	200	32	5	1.700	1	10

**GZC1201 : ZINC DIE CAST CONCEALED HINGE**



**TECHNICAL DATA**

ITEM CODE	SIZE	LENGTH	WIDTH	SCREW NO.	WT/PAIR	PRS. IN INNER	PRS. IN OUTER
ZHIN1201044	44.5X13	44.5	13	5	0.110	5	100
ZHIN1201060	60X13	60	13	5	0.194	5	50
ZHIN1201070	70X16	70	16	5	0.278	5	50
ZHIN1201095	95X19	95	19	6	0.580	5	30
ZHIN1201025	117X25.5	117	25.5	7	1.288	2	10
ZHIN1201116	117X28	117	28	7	1.606	2	10
ZHIN1201137	139X35	139	35	7	2.066	2	10

**STAINLESS STEEL TWO BALL BEARING HINGES**
**Certifire Certified  $\text{CE 13}$  BSEN 1935**
**1121-CRR-AC0067**

**TECHNICAL DATA**

DPG CODE	ITEM CODE	SIZE	LENGTH	WIDTH	THICKNESS	SCREW NO.	WT/ PAIR	PRS. IN INNER	PRS. IN OUTER	PRS. IN PALLET
551SSBB	SHIN1001100	4"X3"	101	76	3.0	10	0.480	1	40	1800
551SSBB	SHIN1002100	4"X3.5"	101	90	3.0	10	0.540	1	40	1360
551SSBB	SHIN1003100	4"X4"	101	101	3.0	10	0.590	1	40	1360
551SSBB	SHIN1004114	4.5"X4"	114	101	3.4	10	0.768	1	20	1020
551SSBB	SHIN1005125	5"X3"	125	76	3.0	10	0.610	1	30	1080
551SSBB	SHIN1006150	6"X3"	150	76	3.0	10	0.780	1	20	1020

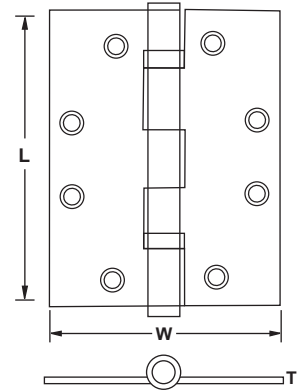
**FINISH AVAILABLE - MIRROR POLISHED, ELECTRO BRASS, SATIN, BLACK NICKEL  
ALSO AVAILABLE IN RADIUS CORNER**

4	7	6	1	1	4	0	13
---	---	---	---	---	---	---	----

**1935:2002**
**CF 714**
**CE 1121**
**FIRE TESTED  
30/60/90  
120/240**
**ANTI CORROSIVE  
240 Hrs.**
**STAINLESS STEEL TWO BALL BEARING HINGES**
**Certifire Certified  $\text{CE 11}$  BSEN 1935**
**1121-CRR-AC5104**

**TECHNICAL DATA**

DPG CODE	ITEM CODE	SIZE	LENGTH	WIDTH	THICK.	SCREW NO.	WT/ PAIR	PRS. IN INNER	PRS. IN OUTER	PRS. IN PALLET
451SSBBTP	SHIN4515100	4"X3"	101	76	2.6	10	0.422	1	40	1800
451SSBBTP	SHIN4517100	4"X3"	101	76	3	10	0.480	1	40	1800
451SSBBTP	SHIN4519100	4"X3.5"	101	88	3	10	0.540	1	40	1360
451SSBBTP	SHIN4522100	4"X4"	101	101	3	10	0.590	1	40	1360

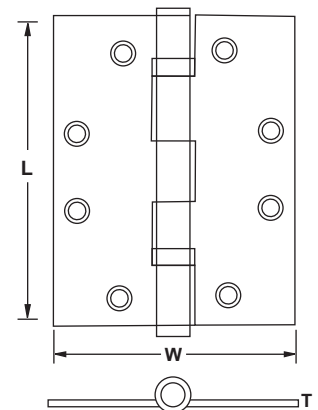
**FINISH AVAILABLE - MIRROR POLISHED, ELECTRO BRASS, SATIN, BLACK NICKEL  
ALSO AVAILABLE IN RADIUS CORNER**

3	7	4	1	1	3	0	11
---	---	---	---	---	---	---	----

**1935:2002**
**CF 714**
**CE 1121**
**FIRE TESTED  
30/60/90/120**
**ANTI CORROSIVE  
240 Hrs.**



**STAINLESS STEEL TWO BALL BEARING HINGES**
**Certifire Certified  $\text{CE}$  7 BSEN 1935**
**1121-CRR-AC5058**
**TECHNICAL DATA**

DPG CODE	ITEM CODE	SIZE	LENGTH	WIDTH	THICKNESS	SCREW NO.	WT/ PAIR	PRS. IN INNER	PRS. IN OUTER	PRS. IN PALLET
451SSBBTP	SHIN4510075	3"X4"	76	101	2	8	0.320	1	50	3000
451BBTP	SHIN4511075	3"X2"	76	50	2	8	0.200	1	50	3200
451BBTP	SHIN4512075	3"X2.5"	76	62	2	8	0.230	1	50	3200
451BBTP	SHIN4513075	3"X3"	76	76	2	8	0.260	1	50	3200
451BBTP	SHIN4515100	4"X3"	101	76	2.6	10	0.420	1	40	1800
451BBTP	SHIN4517100	4"X3"	101	76	3	10	0.480	1	40	1800
451BBTP	SHIN4519100	4"X3.5"	101	88	3	10	0.540	1	40	1360
451BBTP	SHIN4522100	4"X4"	101	101	3	10	0.590	1	40	1360
451BBTP	SHIN4523114	4.5"X4"	114	101	3	10	0.700	1	20	1020

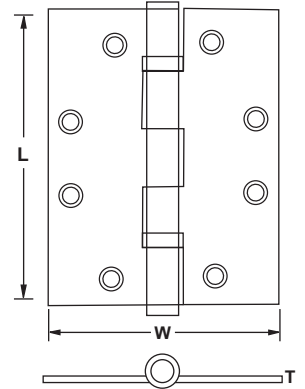
**FINISH AVAILABLE - MIRROR POLISHED, ELECTRO BRASS, SATIN, BLACK NICKEL  
ALSO AVAILABLE IN RADIUS CORNER**

2	7	2	1	1	2	0	7
---	---	---	---	---	---	---	---

**1935:2002**

**CF 714**

**CE 1121**

**FIRE TESTED  
30/60/90/120**

**ANTI CORROSIVE  
240 Hrs.**
**STAINLESS STEEL BUTT HINGE PLAIN JOINT**
**Certifire Certified  $\text{CE}$  7 BSEN 1935**
**1121-CRR-AC5057**
**TECHNICAL DATA**

DPG CODE	ITEM CODE	SIZE	LENGTH	WIDTH	THICKNESS	SCREW NO.	WT/ PAIR	PRS. IN INNER	PRS. IN OUTER	PRS. IN PALLET
453SS	SHIN0453075	3"	76	49	1.9	8	0.150	10	100	4800
453SS	SHIN0453100	4"	101	71	1.9	8	0.290	5	60	3200
2020SS	SHIN2020090	3.5"	90	49	1.9	8	0.175	10	80	4500
453SST*	SHIN6463100	4"	101	71	1.9	8	0.290	5	60	3200

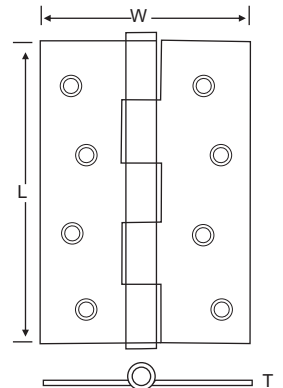
**T\* - Templet Hole**
**FINISH AVAILABLE - MIRROR POLISHED, ELECTRO BRASS, SATIN, BLACK NICKEL  
ALSO AVAILABLE IN RADIUS CORNER**

2	7	2	1	1	2	0	7
---	---	---	---	---	---	---	---

**1935:2002**

**CF 714**

**CE 1121**

**FIRE TESTED  
30/60/90/120**

**ANTI CORROSIVE  
240 Hrs.**

**STAINLESS STEEL BUTT HINGE PLAIN JOINT**

**Certifire Certified  $\text{CE}$  7 BSEN 1935**

**1121-CRR-AC5057**

**TECHNICAL DATA**



DPG CODE	ITEM CODE	SIZE	LENGTH	WIDTH	THICKNESS	SCREW NO.	WT/ PAIR	PRS. IN INNER	PRS. IN OUTER	PRS. IN PALLET
451SS	SHIN0451076	3"	76	64	2.35	8	0.270	10	60	3500
451SS	SHIN0451090	3.5"	90	64	2.35	8	0.315	10	60	2400
451SS	SHIN0451100	4"	101	64	2.5	10	0.382	5	40	1800
451SS	SHIN1451100	4"	101	76	2.5	10	0.428	5	40	1800
451SS	SHIN1452100	4"	101	76	2.85	10	0.460	5	40	1800
451SST*	SHIN3451100	4"	101	76	2.5	10	0.428	5	40	1800
451SST*	SHIN5451100	4"	101	76	2.85	10	0.460	5	40	1800
451SST*	SHIN6461100	4"	101	64	2.5	10	0.382	5	40	1800

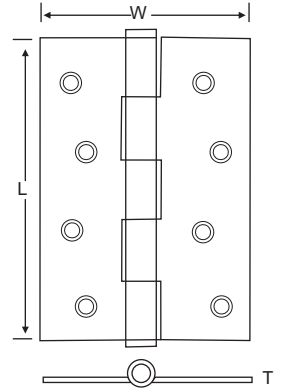

T\* - Templet Hole

**FINISH AVAILABLE - MIRROR POLISHED, ELECTRO BRASS, SATIN, BLACK NICKEL  
ALSO AVAILABLE IN RADIUS CORNER**

2 7 2 1 1 2 0 7



1935:2002



CF 714



CE 1121



FIRE TESTED  
30/60/90/120



ANTI CORROSIVE  
240 Hrs.

**551BB(SSP/DSP): STAINLESS STEEL BALL BEARING HINGE (SINGLE / DOUBLE SECURITY PINS)**



**TECHNICAL DATA**

ITEM CODE	SIZE	LENGTH	WIDTH	THICKNESS	SCREW NO.	WT/ PAIR	PRS. IN INNER	PRS. IN OUTER	PRS. IN PALLET
SHIN0556100	4"x4"	100	100	2.6	10	0.540	1	40	1800
SHIN0557100	4"x3"	101	76	3.0	10	0.480	1	40	1360

**FINISH AVAILABLE - MIRROR, POLISHED, ELECTRO BRASS,  
SATIN, BLACK NICKEL**

**Currently Under Assessment**

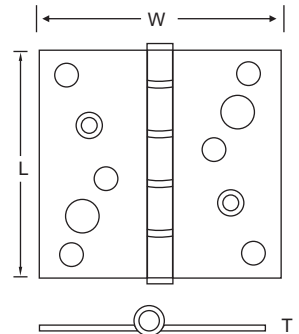

**MILD STEEL TWO BALL BEARING HINGES**
**Certifire Certified  BSEN 1935**
**1121-CRR-AC5104**

**TECHNICAL DATA**

DPG CODE	ITEM CODE	SIZE	LENGTH	WIDTH	THICKNESS	SCREW NO.	WT/ PAIR	PRS. IN INNER	PRS. IN OUTER	PRS. IN PALLET
451BBTP	MHIN4515100	4"X3"	101	76	2.6	10	0.422	1	40	1800
451BBTP	MHIN4517100	4"X3"	101	76	3	10	0.480	1	40	1800
451BBTP	MHIN4519100	4"X3.5"	101	88	3	10	0.540	1	40	1360
451BBTP	MHIN4522100	4"X4"	101	101	3	10	0.590	1	40	1360

**FINISH AVAILABLE - SC, BZP, ARJUNA, YPZP, EB, EXB, EXW, CP, SNP, ANTIQUE BRASS , DUROSIL**
**ALSO AVAILABLE IN RADIUS CORNER**

3	7	4	1	1	3	0	11
---	---	---	---	---	---	---	----

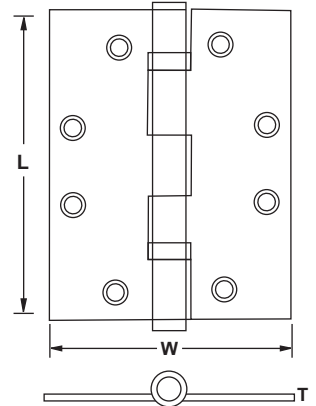
**1935:2002**

**CF 714**

**CE 1121**

**FIRE TESTED 30/60/90/120**

**ANTI CORROSIVE 96 Hrs.**
**MILD STEEL TWO BALL BEARING HINGES**
**Certifire Certified  BSEN 1935**
**1121-CRR-AC5058**

**TECHNICAL DATA**

DPG CODE	ITEM CODE	SIZE	LENGTH	WIDTH	THICKNESS	SCREW NO.	WT/ PAIR	PRS. IN INNER	PRS. IN OUTER	PRS. IN PALLET
451BBTP	MHIN4510075	3"X4"	76	101	2	8	0.320	1	50	3000
451BBTP	MHIN4511075	3"X2"	76	50	2	8	0.200	1	50	3200
451BBTP	MHIN4512075	3"X2.5"	76	62	2	8	0.230	1	50	3200
451BBTP	MHIN4513075	3"X3"	76	76	2	8	0.260	1	50	3200
451BBTP	MHIN4515100	4"X3"	101	76	2.6	10	0.420	1	40	1800
451BBTP	MHIN4517100	4"X3"	101	76	3	10	0.480	1	40	1800
451BBTP	MHIN4519100	4"X3.5"	101	88	3	10	0.540	1	40	1360
451BBTP	MHIN4522100	4"X4"	101	101	3	10	0.590	1	40	1360
451BBTP	MHIN4523114	4.5"X4"	114	101	3	10	0.700	1	40	1020

**FINISH AVAILABLE - SC, BZP, ARJUNA, YPZP, EB, EXB, EXW, CP, SNP, ANTIQUE BRASS , DUROSIL**
**ALSO AVAILABLE IN RADIUS CORNER**

2	7	2	1	1	2	0	7
---	---	---	---	---	---	---	---

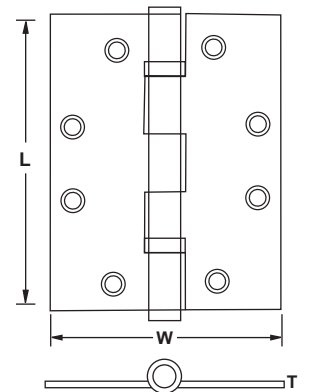
**1935:2002**

**CF 714**

**CE 1121**

**FIRE TESTED 30/60/90/120**

**ANTI CORROSIVE 96 Hrs.**

MILD STEEL BUTT HINGE PLAIN JOINT

Certifire Certified **CE 7** BSEN 1935

1121-CRR-AC5057



TECHNICAL DATA

DPG CODE	ITEM CODE	SIZE	LENGTH	WIDTH	THICKNESS	SCREW NO.	WT/ PAIR	PRS. IN INNER	PRS. IN OUTER	PRS. IN PALLET
804	MHIN0804076	3"	76	76	1.9	8	0.240	10	80	3200
2020	MHIN2020076	3"	76	49	1.9	8	0.150	10	100	4800
2020	MHIN2020090	3.5"	90	49	1.9	8	0.175	10	80	4500
2020	MHIN2020100	4"	101	71	1.9	8	0.290	5	60	3200
5050	MHIN5050075	3"	76	46	1.9	8	0.132	10	100	4800
5050	MHIN5050090	3.5"	90	46	1.9	8	0.170	10	80	4500
5050	MHIN5050100	4"	101	58	1.9	8	0.260	5	60	3200

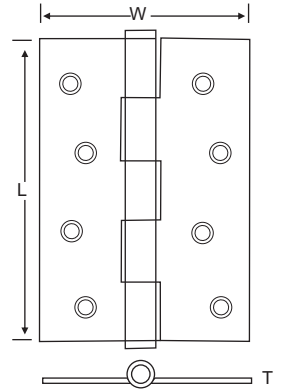

FINISH AVAILABLE - SC, BZP, ARJUNA, YPZP, EB, EXB, EXW, CP, SNP, ANTIQUE BRASS, DUROSIL

ALSO AVAILABLE IN RADIUS CORNER

2 7 2 1 1 2 0 7



1935:2002



CF 714



CE 1121



FIRE TESTED 30/60/90/120



ANTI CORROSIVE 96 Hrs.

MILD STEEL BUTT HINGE PLAIN JOINT

Certifire Certified **CE 7** BSEN 1935

1121-CRR-AC5057



TECHNICAL DATA

DPG CODE	ITEM CODE	SIZE	LENGTH	WIDTH	THICKNESS	SCREW NO.	WT/ PAIR	PRS. IN INNER	PRS. IN OUTER	PRS. IN PALLET
451	MHIN0451075	3"	76	64	2.35	8	0.270	10	60	3500
451	MHIN0451090	3.5"	90	64	2.35	10	0.315	10	60	2400
451	MHIN0451100	4"	101	76	2.5	10	0.428	5	40	1800
451	MHIN451A100	4"	101	76	2.85	10	0.460	5	40	1800
451T*	MHIN451T100	4"	101	76	2.5	10	0.428	5	40	1800
451T*	MHIN5451100	4"	101	76	2.85	10	0.460	5	40	1800

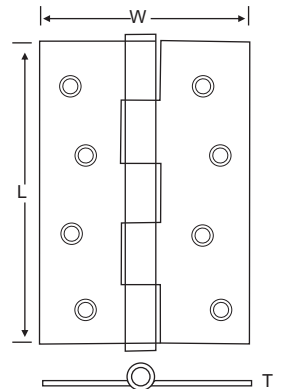

T\* - Templet Hole

FINISH AVAILABLE - SC, BZP, ARJUNA, YPZP, EB, EXB, EXW, CP, SNP, ANTIQUE BRASS, DUROSIL

ALSO AVAILABLE IN RADIUS CORNER

2 7 2 1 1 2 0 7



1935:2002



CF 714



CE 1121



FIRE TESTED 30/60/90/120



ANTI CORROSIVE 96 Hrs.



**453 : STAINLESS STEEL BUTT HINGE STANDARD CRANKED KNUCKLE, FIXED PIN**

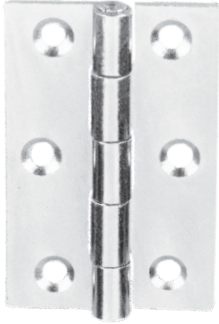

**TECHNICAL DATA**

ITEM CODE	SIZE	LENGTH	WIDTH	THICKNESS	SCREW NO.	WT/ PAIR	PRS. IN INNER	PRS. IN OUTER	PRS. IN PALLET
SHIN0453075	3"	75	49	1.5	7	0.110	10	200	6800
SHIN0453100	4"	101	71	1.8	8	0.280	5	80	3200

FINISH AVAILABLE - MIRROR, POLISHED, ELECTRO BRASS, SATIN, BLACK NICKEL  
ALSO AVAILABLE WITH BUTTON TIP PIN,

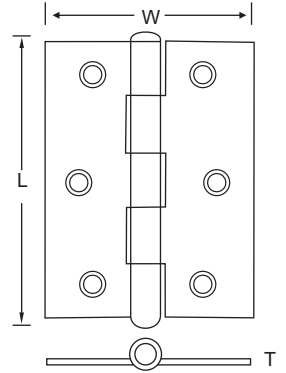

**451SS : STAINLESS STEEL STRONG BUTT HINGES CRANKED KNUCKLE, FIXED PIN**



**TECHNICAL DATA**

ITEM CODE	SIZE	LENGTH	WIDTH	THICKNESS	SCREW NO.	WT/ PAIR	PRS. IN INNER	PRS. IN OUTER	PRS. IN PALLET
SHIN0451050	2"	50	42	2.5	8	0.115	10	200	6800
SHIN0451075	3"	76	64	2.5	10	0.270	10	80	3200
SHIN0451100	4"	101	75	2.6	10	0.420	5	50	2400

FINISH AVAILABLE - MIRROR, POLISHED, ELECTRO BRASS, SATIN, BLACK NICKEL  
Also Available in radius corner Code 451 RC,

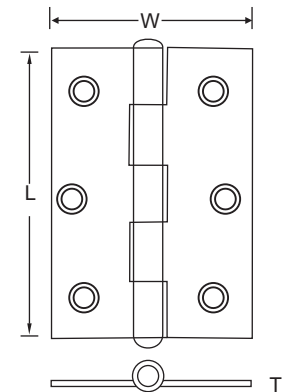

**551W : STAINLESS STEEL BUTT HINGE ( HEAVY DUTY) CRANKED KNUCKLE DOUBLE WASHERED WITH SPUN OR BUTTON TIP PIN**



**TECHNICAL DATA**

ITEM CODE	SIZE	LENGTH	WIDTH	THICKNESS	SCREW NO.	WT/ PAIR	PRS. IN INNER	PRS. IN OUTER	PRS. IN PALLET
SHIN0563100	4"	101	76	2.6	10	0.416	5	50	2400
SHIN0564100	4"	101	76	2.9	12	0.455	5	50	1800
SHIN0565100	4"	101	90	2.6	10	0.480	5	50	1800
SHIN0566100	4"	101	101	2.6	12	0.530	5	40	1800

FINISH AVAILABLE - MIRROR, POLISHED, ELECTRO BRASS, SATIN, BLACK NICKEL  
ALSO AVAILABLE SINGLE WASHER HINGE & BUTTON TIP PIN

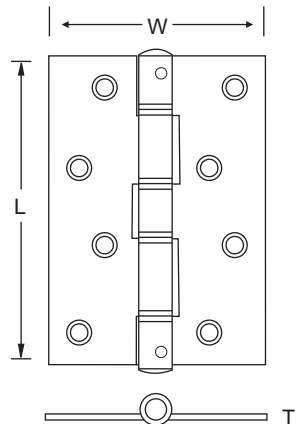

**466SS : STAINLESS STEEL RISING BUTT HINGES HANDED CRANKED KNUCKLE, LIFT - OFF PATTERN, FLUSH PIN**



**TECHNICAL DATA**

ITEM CODE	SIZE	LENGTH	WIDTH	THICKNESS	SCREW NO.	WT/ PAIR	PRS. IN INNER	PRS. IN OUTER	PRS. IN PALLET
SHIN0466075	3"	76	70	2.55	8	0.327	5	80	2100
SHIN0466100	4"	100	80	3.0	10	0.570	5	50	1800

FINISH AVAILABLE - MIRROR, POLISHED, ELECTRO BRASS,  
SATIN, BLACK NICKEL  
AVAILABLE : R/H & L/H

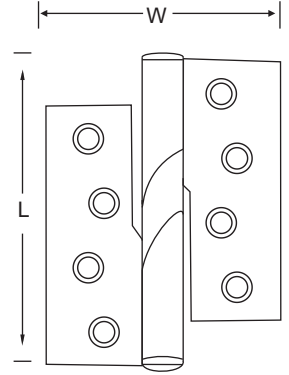

**105SSBB : STAINLESS STEEL FLUSH HINGES KNUCKLE, TWO BALL BEARING AND BUTTON TIP PIN**



**TECHNICAL DATA**

ITEM CODE	SIZE	LENGTH	WIDTH	THICKNESS	SCREW NO.	WT/ PAIR	PRS. IN INNER	PRS. IN OUTER	PRS. IN PALLET
SHIN105101	4"	101	72	2.5	8	0.314	10	60	2700

FINISH AVAILABLE - MIRROR, POLISHED, ELECTRO BRASS  
SATIN, BLACK NICKEL

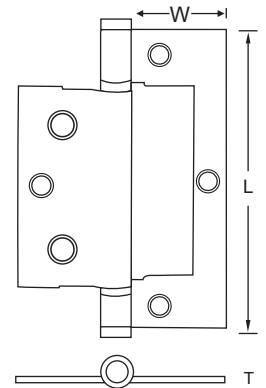

**459SS : STAINLESS STEEL SUPPORTING HINGES KNUCKLE, HANDED**

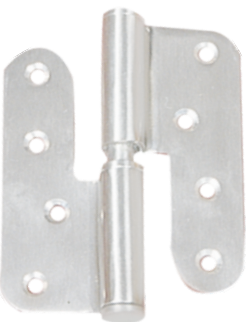

**TECHNICAL DATA**

ITEM CODE	SIZE	LENGTH	WIDTH	THICKNESS	SCREW NO.	WT/ PAIR	PRS. IN INNER	PRS. IN OUTER	PRS. IN PALLET
SHIN459L100	4"	100	86	3.0	10	0.600	5	30	1350

FINISH AVAILABLE - MIRROR, POLISHED, ELECTRO BRASS, SATIN, BLACK NICKEL  
AVAILABLE : R/H & L/H

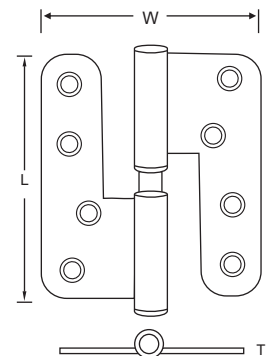

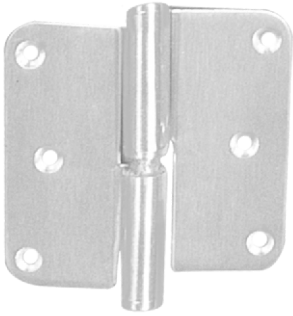
**458SSRC :STAINLESS STEEL RADIUS CORNER HINGES HANDED- CRANKED KNUCKLE, LIFT - OFF**

**TECHNICAL DATA**

ITEM CODE	SIZE	LENGTH	WIDTH	THICKNESS	SCREW NO.	WT/ PAIR	PRS. IN INNER	PRS. IN OUTER	PRS. IN PALLET
SHIN0458080	3"	80	80	2.5	7	0.315	5	60	2700

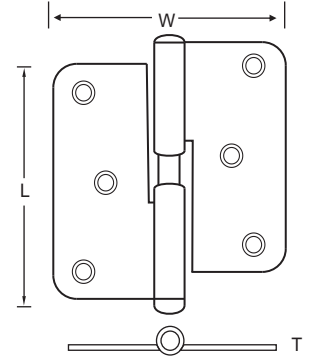
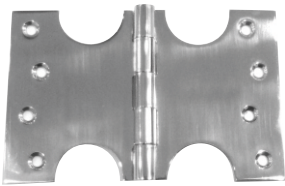
FINISH AVAILABLE - MIRROR, POLISHED, ELECTRO BRASS, SATIN, BLACK NICKEL  
AVAILABLE : R/H & L/H

**3210SS: STAINLESS STEEL PARLIAMENT HINGE**

**TECHNICAL DATA**

ITEM CODE	SIZE	LENGTH	WIDTH	OPEN WIDTH	THICKNESS	SCREW NO.	WT/ PAIR	PRS. IN INNER	PRS. IN OUTER	PRS. IN PALLET
SHIN3210075	4"x3"	100	76	122	2.5	6	0.546	2	30	1560
SHIN3210100	4"x4"	100	102	158	2.5	10	0.628	2	30	1560
SHIN3210125	4"x5"	100	125	185	2.5	10	0.704	2	20	1040
SHIN3210150	4"x6"	100	150	205	2.5	10	0.770	1	20	1040
SHIN3210200	4"x8"	100	200	270	2.5	10	0.974	1	20	780

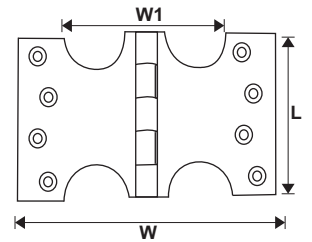
FINISH AVAILABLE - MIRROR, POLISHED, ELECTRO BRASS,  
SATIN, BLACK NICKEL

**1838 : MILD STEEL BUTT HINGES CRANKED KNUCKLE, FIXED PIN**

ITEM CODE	SIZE	LENGTH	WIDTH	THICKNESS	N.H.	SCREW NO.	WT/PAIR	PRS. IN INNER	PRS. IN OUTER	PRS. IN PALLET
MHIN1838025	1"	25	25	1.2	4	4	0.016	25	1400	63000
MHIN1838040	1.5"	40	33	1.3	4	4	0.035	10	600	21600
MHIN1838050	2"	50	36	1.4	4	6	0.052	10	400	16800
MHIN1838065	2.5"	65	44	1.4	6	6	0.082	10	250	10000
MHIN1838075	3"	75	49	1.4	6	7	0.111	10	200	9000
MHIN1838090	3.5"	90	56	1.75	6	8	0.190	10	100	4000
MHIN1838100	4"	100	71	1.75	8	8	0.260	5	80	3200
MHIN1838150	6"	150	98	2.15	8	10	0.740	5	30	1200

FINISH AVAILABLE - SC, BZP, ARJUNA, YPZP, EB, EXB, EXW, CR, SCP, PCP, SNP,  
ANTIQUE BRASS , DUROSIL  
Also Available in Radius corner Code 1838 RC

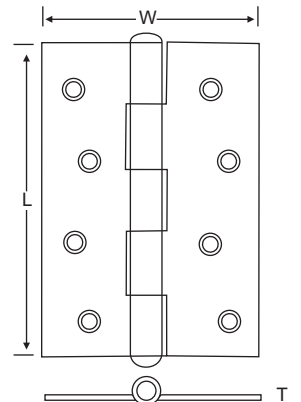

**1840 : MILD STEEL BUTT HINGES CRANKED KNUCKLE, REMOVABLE PIN**



ITEM CODE	SIZE	LENGTH	WIDTH	THICKNESS	SCREW NO.	WT/PAIR	PRS. IN INNER	PRS. IN OUTER	PRS. IN PALLET
MHIN1840050	2"	50	36	1.4	6	0.056	10	400	16800
MHIN1840065	2.5"	65	44	1.4	6	0.082	10	250	10000
MHIN1840075	3"	75	49	1.4	7	0.111	10	200	9000
MHIN1840090	3.5"	90	55	1.75	8	0.190	10	100	4000
MHIN1840100	4"	100	71	1.75	8	0.260	5	80	3200

FINISH AVAILABLE - SC, BZP, ARJUNA, YPZP, EB, EXB, EXW, CP, SCP, PCP, SNP,  
ANTIQUE BRASS, DUROSIL  
Also Available In Radius Corner Code 1840 RC

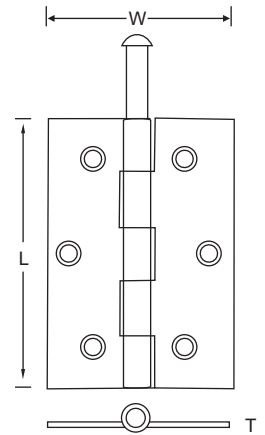

**5050 : MILD STEEL NARROW BUTT HINGES UNCRANKED KNUCKLE, FIXED PIN**



ITEM CODE	SIZE	LENGTH	WIDTH	THICKNESS	N.H.	SCREW NO.	WT/PAIR	PRS. IN INNER	PRS. IN OUTER	PRS. IN PALLET
MHIN5050025	1"	25	24	1.2	4	4	0.016	25	1400	63000
MHIN5050040	1.5"	40	32	1.4	4	4	0.035	10	600	21600
MHIN5050050	2"	50	37	1.5	6	6	0.056	10	400	16800
MHIN5050065	2.5"	65	41	1.5	6	6	0.085	10	250	10000
MHIN5050075	3"	75	47	1.5	6	7	0.116	10	160	9000
MHIN5050090	3.5"	90	54	1.7	6	7	0.190	10	100	4000
MHIN5050100	4"	100	58	1.7	8	8	0.220	5	80	3200
MHIN5050125	5"	125	65	1.7	8	8	0.315	5	50	2500
MHIN5050150	6"	150	75	2	8	10	0.456	5	30	1800

FINISH AVAILABLE - SC, BZP, ARJUNA, YPZP, EB, EXB, EXW, CP, SCP, PCP, SNP,  
ANTIQUE BRASS, DUROSIL

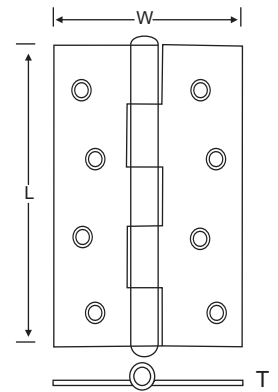

**451 : MILD STEEL STRONG BUTT HINGES CRANKED KNUCKLE, FIXED PIN**

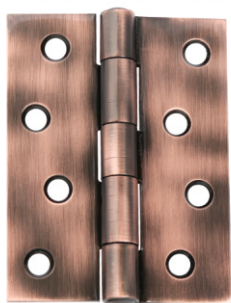

ITEM CODE	SIZE	LENGTH	WIDTH	THICKNESS	SCREW NO.	WT/PAIR	PRS. IN INNER	PRS. IN OUTER	PRS. IN PALLET
MHIN0451050	2"	50	42	2.5	8	0.115	10	200	6800
MHIN0451075	3"	76	64	2.5	10	0.270	10	80	3200
MHIN0451100	4"	101	75	2.6	10	0.420	5	50	2400
MHIN451H100	4"	101	76	3.55	12	0.550	5	40	1600

FINISH AVAILABLE - SC, BZP, ARJUNA, YPZP, EB, EXB, EXW, CP, SCP, PCP, SNP,  
ANTIQUE BRASS, DUROSIL  
ALSO AVAILABLE IN RADIUS CORNER CODE 451 RC,

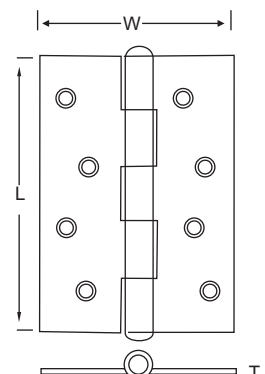



**451 DPBW :**

**MILD STEEL DOUBLE PHOSPHOROUS BRONZE WASHERED HINGES**

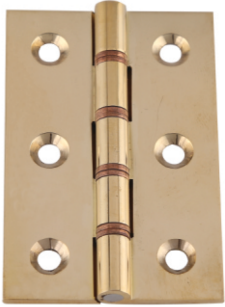

ITEM CODE	SIZE	LENGTH	WIDTH	THICKNESS	SCREW NO.	WT/PAIR	PRS. IN INNER	PRS. IN OUTER	PRS. IN PALLET
MHIN1451075	3"	75	48	2.0	7	0.150	10	80	4000
MHIN1451100	4"	101	75	2.5	10	0.416	5	50	2400

FINISH AVAILABLE - SC, BZP, ARJUNA, YPZP, EB, EXB, EXW, CP, SCP, PCP, SNP, ANTIQUE BRASS , DUROSIL

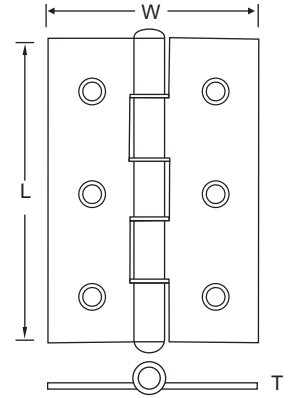

**451 DSW :MILD STEEL DOUBLE STEEL WASHERED HINGES**

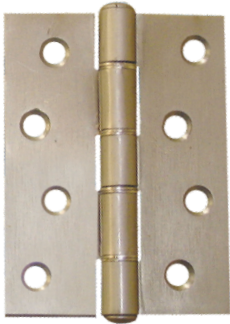

ITEM CODE	SIZE	LENGTH	WIDTH	THICKNESS	SCREW NO.	WT/PAIR	PRS. IN INNER	PRS. IN OUTER	PRS. IN PALLET
MHIN1454075	3"	75	48	2.0	7	0.150	10	80	4000
MHIN1454100	4"	101	75	2.5	10	0.416	5	50	2400

FINISH AVAILABLE - SC, BZP, ARJUNA, YPZP, EB, EXB, EXW, CP, SCP, PCP, SNP, ANTIQUE BRASS , DUROSIL

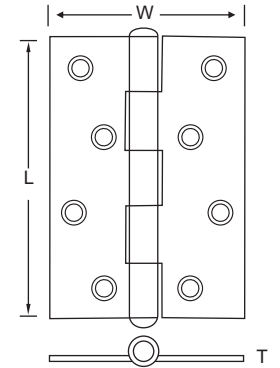

**899 :**

**MILD STEEL EXTRA STRONG DOUBLE FLAP BUTT HINGES UNCRANKED KNUCKLE, FIXED PIN**

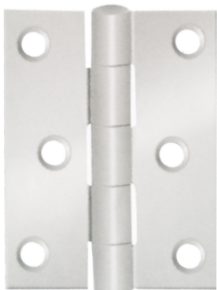

**TECHNICAL DATA**

ITEM CODE	SIZE	LENGTH	SIZE WIDTH	THICKNESS	SCREW NO.	WT/PAIR	PRS. IN INNER	PRS. IN OUTER	PRS. IN PALLET
MHIN0899075	3"	76	60	4.0	10	0.320	10	60	2400
MHIN0899100	4"	101	72	4.3	12	0.490	5	40	1600
MHIN0899150	6"	152	102	6.0	12	1.610	2	12	600

FINISH AVAILABLE - SC, BZP, ARJUNA, YPZP, EB, EXB, EXW, CP, SCP, PCP, SNP, ANTIQUE BRASS , DUROSIL

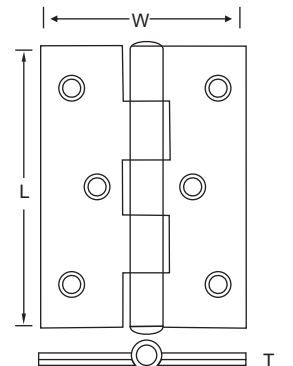

**457 : MILD STEEL LIFT OFF HINGES - HANDED CRANKED KNUCKLE**

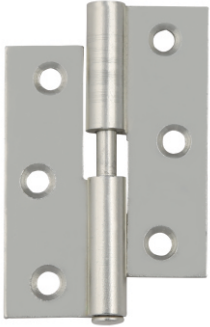

**TECHNICAL DATA**

ITEM CODE	SIZE	LENGTH	SIZE WIDTH	THICKNESS	SCREW NO.	WT/ PAIR	PRS. IN INNER	PRS. IN OUTER	PRS. IN PALLET
MHIN457L065	2.5"	65	52	2.0	8	0.135	10	120	4800
MHIN457L075	3"	75	56	2.6	10	0.230	10	80	4320
MHIN457L100	4"	100	73	2.6	10	0.364	5	50	2000
MHIN457R065	2.5"	65	52	2.0	8	0.135	10	120	4800
MHIN457R075	3"	75	56	2.6	10	0.230	10	80	4320
MHIN457R100	4"	100	73	2.6	10	0.364	5	50	2000

FINISH AVAILABLE - SC, BZP, ARJUNA, YPZP, EB, EXB, EXW, CP, SCP, PCP, SNP, ANTIQUE BRASS , DUROSIL

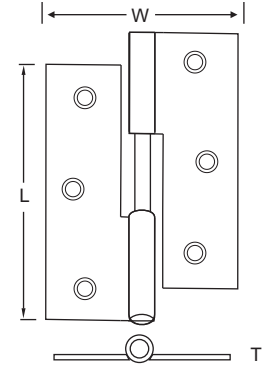

**466 : MILD STEEL RISING BUTT HINGES HANDED- CRANKED KNUCKLE LIFT- OFF PATTERN, FLUSH PIN**



**TECHNICAL DATA**

ITEM CODE	SIZE	LENGTH	SIZE WIDTH	THICKNESS	SCREW NO.	WT/PAIR	PRS. IN INNER	PRS. IN OUTER	PRS. IN PALLET
MHIN466L075	3"	76	73	2.55	8	0.320	5	70	2100
MHIN466L100	4"	100	77	2.8	10	0.530	5	35	1890
MHIN466R075	3"	76	73	2.55	8	0.320	5	70	2100
MHIN466R100	4"	100	77	2.8	10	0.530	5	35	1890

FINISH AVAILABLE - SC, BZP, ARJUNA, YPZP, EB, EXB, EXW, CP, SCP, PCP, SNP, ANTIQUE BRASS , DUROSIL

Note : Also available in Stainless Steel 18/8 (Gr. - 304 ) Code 466 SS

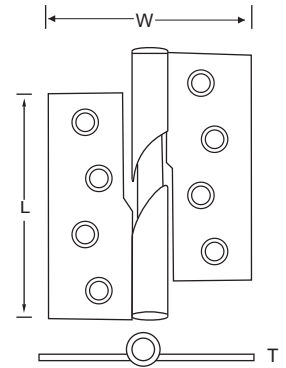

**458RC : MILD STEEL RADIUS CORNER HINGES HANDED- CRANKED KNUCKLE, LIFT - OFF**



**TECHNICAL DATA**

ITEM CODE	SIZE	LENGTH	WIDTH	THICKNESS	SCREW NO.	WT/ PAIR	PRS. IN INNER	PRS. IN OUTER	PRS. IN PALLET
MHIN458R080	3"	80	80	2.5	7	0.314	5	80	2700
MHIN458L080	3"	80	80	2.5	7	0.314	5	80	2700

FINISH AVAILABLE - SC, BZP, ARJUNA, YPZP, EB, EXB, EXW, CP, SCP, PCP, SNP, ANTIQUE BRASS , DUROSIL

Note : Also available in Stainless Steel 18/8 (Gr. - 304 ) Code 458 SSRC

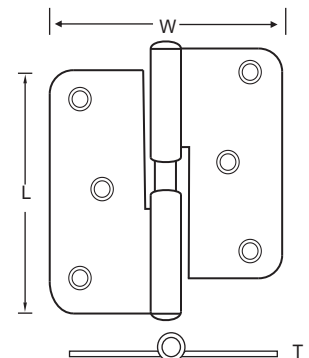

**488 : MILD STEEL PARLIAMENT HINGES UNCRANKED KNUCKLE, FIXED PIN**

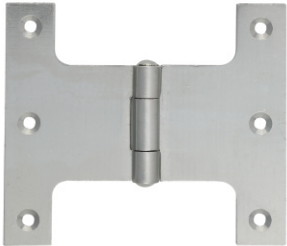

**TECHNICAL DATA**

ITEM CODE	SIZE	LENGTH	WIDTH	THICKNESS	SCREW NO.	WT/ PAIR	PRS. IN INNER	PRS. IN OUTER	PRS. IN PALLET
MHIN0488050	2"	100	50	2.24	8	0.285	10	80	3040
MHIN0488065	2.5"	100	65	2.24	8	0.305	10	70	1960
MHIN0488075	3"	100	75	2.24	8	0.320	5	70	1960
MHIN0488100	4"	125	100	2.5	8	0.600	5	35	1260
MHIN0488125	5"	125	125	2.5	10	0.672	5	30	1260
MHIN0488150	6"	125	150	2.5	10	0.716	5	30	1260
MHIN0488200	8"	125	200	2.5	10	0.882	5	20	1000

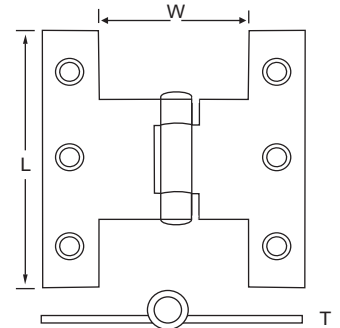

FINISH AVAILABLE - SC, BZP, ARJUNA, YPZP, EB, EXB, EXW, CP, SCP, PCP, SNP, ANTIQUE BRASS, DUROSIL

**3210 : MILD STEEL HALF ROUND PARLIAMENT HINGES (UNCRANKED KNUCKLE, FIXED PIN)**

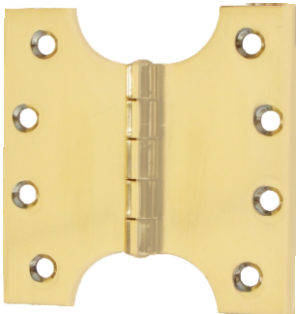

**TECHNICAL DATA**

ITEM CODE	SIZE	LENGTH	WIDTH	THICKNESS	SCREW NO.	WT/ PAIR	PRS. IN INNER	PRS. IN OUTER	PRS. IN PALLET
MHIN3210100	4"x2"x4"x3mm	101	50	3.0	10	0.440	10	40	1800

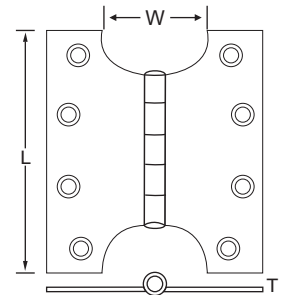

FINISH AVAILABLE - SC, BZP, ARJUNA, YPZP, EB, EXB, EXW, CP, SCP, PCP, SNP, ANTIQUE BRASS, DUROSIL

**1951 : MILD STEEL STORMPROOF BUTT HINGES FIXED PIN**



**TECHNICAL DATA**

ITEM CODE	SIZE	LENGTH	WIDTH	THICKNESS	SCREW NO.	WT/ PAIR	PRS. IN INNER	PRS. IN OUTER	PRS. IN PALLET
MHIN1951063	2.5"	63	58	1.7	8	0.175	10	120	5400
MHIN1951100	4"	101	72	2.0	8	0.400	5	40	1800

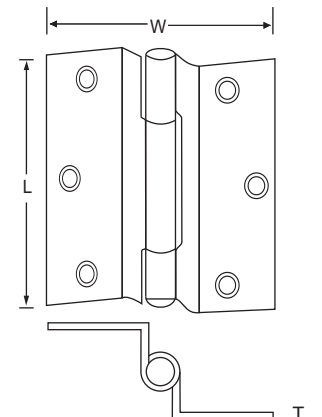

FINISH AVAILABLE - SC, BZP, ARJUNA, YPZP, EB, EXB, EXW, CP, SNP, ANTIQUE BRASS, DUROSIL

**1951FF : MILD STEEL STORMPROOF HINGES (UNEQUAL)**



**TECHNICAL DATA**

ITEM CODE	SIZE	LENGTH	WIDTH	THICKNESS	SCREW NO.	WT/ PAIR	PRS. IN INNER	PRS. IN OUTER	PRS. IN PALLET
MHIN1954063	2.5"	63	63	1.8	8	0.180	10	120	5400

FINISH AVAILABLE - SC, BZP, ARJUNA, YPZP, EB, EXB, EXW, CP, SNP, ANTIQUE BRASS , DUROSIL

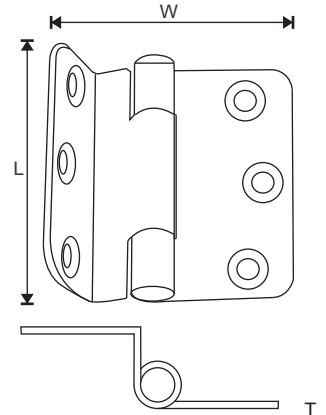

**1951EH : MILD STEEL STORMPROOF HINGES (EXTRA HOLES)**



**TECHNICAL DATA**

ITEM CODE	SIZE	LENGTH	WIDTH	THICKNESS	SCREW NO.	WT/ PAIR	PRS. IN INNER	PRS. IN OUTER	PRS. IN PALLET
MHIN1956063	2.5"	63	58	1.8	8	0.180	10	120	5400

FINISH AVAILABLE - SC, BZP, ARJUNA, YPZP, EB, EXB, EXW, CP, SNP, ANTIQUE BRASS , DUROSIL

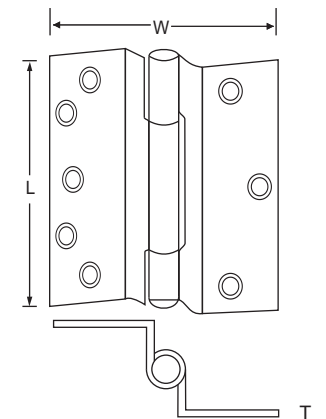

**3207 : MILD STEEL STORMPROOF HINGE WITH GAP (1951CR)**



**TECHNICAL DATA**

ITEM CODE	SIZE	LENGTH	WIDTH	THICKNESS	SCREW NO.	WT/ PAIR	PRS. IN INNER	PRS. IN OUTER	PRS. IN PALLET
MHIN3207063	2.5"	63	58	1.6	7	0.154	10	120	5400

FINISH AVAILABLE - SC, BZP, ARJUNA, YPZP, EB, EXB, EXW, CP, SNP, ANTIQUE BRASS , DUROSIL

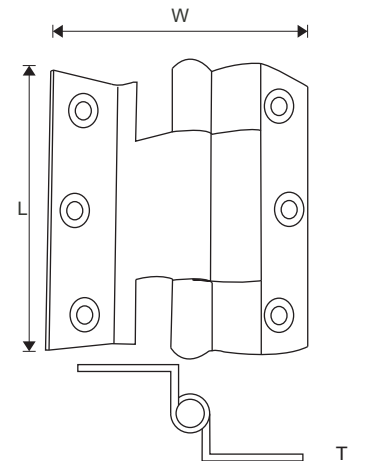



**459 : MILD STEEL SUPPORTING HINGES (OR) OFFSET HINGES - HANDED- CRANKED KNUCKLE**



**TECHNICAL DATA**

ITEM CODE	SIZE	LENGTH	WIDTH	THICKNESS	SCREW NO.	WT/ PAIR	PRS. IN INNER	PRS. IN OUTER	PRS. IN PALLET
MHIN459R100	4"	100	86	3.0	10	0.600	5	30	1350
MHIN459R110	4.5"	110	96	3.0	12	0.630	5	30	1350
MHIN459L100	4"	100	86	3.0	10	0.600	5	30	1350
MHIN459L110	4.5"	110	96	3.0	12	0.630	5	30	1350

FINISH AVAILABLE - SC, BZP, ARJUNA, YPZP, EB, EXB, EXW, CP, SNP,  
ANTIQUE BRASS , DUROSIL  
AVAILABLE IN L/H & R/H

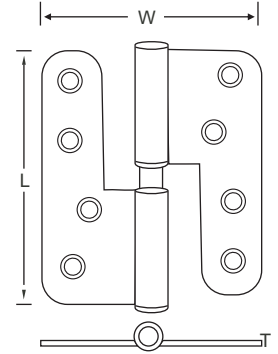

**460 : MILD STEEL JOURNAL SUPPORT HINGES HANDED- CRANKED & KNOTCHED KNUCKLE ( WITH OIL SLOT)**



**TECHNICAL DATA**

ITEM CODE	SIZE	LENGTH	WIDTH	THICKNESS	SCREW NO.	WT/ PAIR	PRS. IN INNER	PRS. IN OUTER	PRS. IN PALLET
MHIN460L098	4"	98	81	2.5	10	0.435	5	50	1800
MHIN460L110	4.5"	110	98	3.15	10	0.656	5	30	1350
MHIN460R098	4"	98	81	2.5	10	0.435	5	50	1800
MHIN460R110	4.5"	110	98	3.15	10	0.656	5	30	1350

FINISH AVAILABLE - SC, BZP, ARJUNA, YPZP, EB, EXB, EXW, CP, SNP,  
ANTIQUE BRASS , DUROSIL  
AVAILABLE IN L/H & R/H

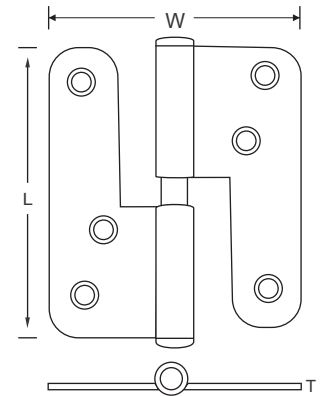

**804H : MILD STEEL BROAD SQUARE HEAVY BUTT HINGES CRANKED KNUCKLE**

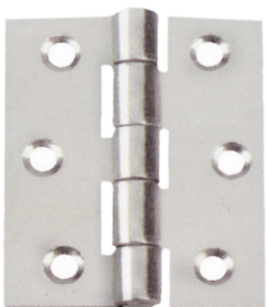

**TECHNICAL DATA**

ITEM CODE	SIZE	LENGTH	WIDTH	THICKNESS	SCREW NO.	WT/ PAIR	PRS. IN INNER	PRS. IN OUTER	PRS. IN PALLET
MHIN8041076	3"X3"	76	76	2.0	8	0.240	10	80	3200
MHIN8041080	3.15"X3.15"	80	80	2.5	8	0.280	10	80	3200
MHIN8041090	3.5"X3.5"	89	89	2.5	8	0.410	5	50	2000
MHIN8041101	4"X4"	101	101	3.1	12	0.640	5	35	1400
MHIN8041114	4.5"X4.5"	114	114	3.5	12	0.890	5	20	1000

FINISH AVAILABLE - SC, BZP, ARJUNA, YPZP, EB, EXB, EXW, CP, SNP,  
ANTIQUE BRASS , DUROSIL

Also Available in loose pin ( Code 804LP) and in Radius Corner (Code 804 HRC)

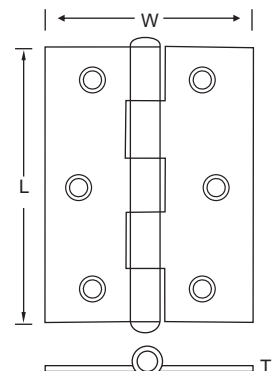

**452DS/FP :**
**MILD STEEL BUTT HINGES DOUBLE SECURITY PINS**

**TECHNICAL DATA**

ITEM CODE	SIZE	LENGTH	WIDTH	THICKNESS	SCREW NO.	WT/ PAIR	PRS. IN INNER	PRS. IN OUTER	PRS. IN PALLET
MHIN1452100	4"X3.5"	101	90	2.5	8	0.450	5	50	1800

FINISH AVAILABLE - SC, BZP, ARJUNA, YPZP, EB, EXB, EXW, CP, SNP, ANTIQUE BRASS, DUROSIL

Also available - Loose pin (Code 452 DS/LP)

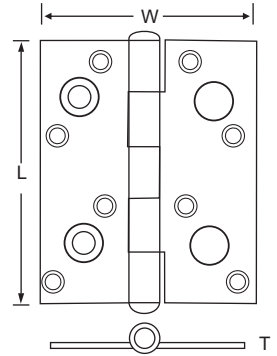
**400 :**
**MILD STEEL BACK FLAP (TABLE) HINGES CRANKED KNUCKLE, FIXED PIN**

**TECHNICAL DATA**

ITEM CODE	SIZE	LENGTH	WIDTH	THICKNESS	SCREW NO.	WT/ PAIR	PRS. IN INNER	PRS. IN OUTER	PRS. IN PALLET
MHIN0400025	1"	25	74	1.6	6	0.052	25	400	16000
MHIN0400030	1.25"	30	77	1.6	7	0.062	10	300	16200
MHIN0400040	1.5"	40	87	1.6	8	0.099	10	150	9000
MHIN0400050	2"	50	106	2.0	8	0.182	10	100	5700
MHIN0400065	2.5"	65	153	2.2	10	0.360	10	50	2500
MHIN0400075	3"	75	168	2.5	10	0.500	5	50	1800

FINISH AVAILABLE - SC, BZP, ARJUNA, YPZP, EB, EXB, EXW, CP, SNP, ANTIQUE BRASS, DUROSIL  
ALSO AVAILABLE UNCRANKED (404)

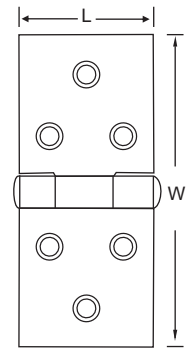

**400BP :**
**MILD STEEL BACK FLAP (TABLE) HINGES WITH BENT PIN**

**TECHNICAL DATA**

ITEM CODE	SIZE	LENGTH	WIDTH	THICKNESS	SCREW NO.	WT/ PAIR	PRS. IN INNER	PRS. IN OUTER	PRS. IN PALLET
MHIN400B040	1.5"	40	85	1.5	7	0.098	10	150	9000
MHIN400B050	2"	50	104	2.0	8	0.185	10	100	5700

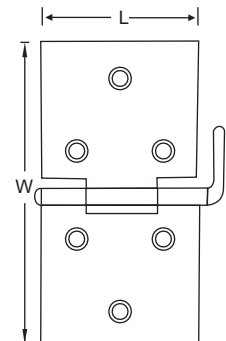
FINISH AVAILABLE - SC, BZP, ARJUNA, YPZP, EB, EXB, EXW, CP, SNP, ANTIQUE BRASS, DUROSIL  
ALSO AVAILABLE UNCRANKED (404)

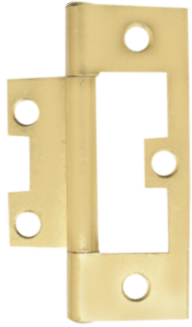

**105 : MILD STEEL FLUSH HINGES UNCRANKED KNUCKLE, FIXED PIN**
**TECHNICAL DATA**

ITEM CODE	SIZE	LENGTH	WIDTH	THICKNESS	SCREW NO.	WT/ PAIR	PRS. IN INNER	PRS. IN OUTER	PRS. IN PALLET
MHIN0105038	1.5"	40	32	1.0	4	0.020	25	1200	43200
MHIN0105050	2"	50	38	1.2	4	0.031	25	600	27000
MHIN0105065	2.5"	60	40	1.2	4	0.036	25	500	27000
MHIN0105075	3"	76	52	1.5	6	0.089	25	225	9000
MHIN0105100	4"	100	60	2.0	8	0.228	10	100	4000

FINISH AVAILABLE - SC, BZP, ARJUNA, YPZP, EB, EXB, EXW, CP, SNP,  
ANTIQUE BRASS , DUROSIL

Note : Also available in Finial pins ( Code 105 FLP) Rounded corners ( Code 105 RC )  
and Rounded corners with Finial Pins ( 105 RCF)

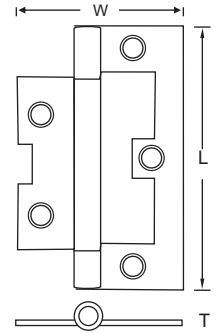
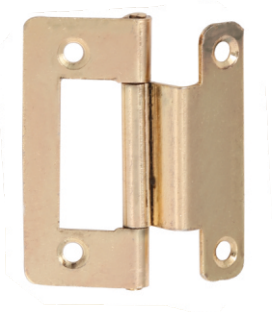
**118 : MILD STEEL CRANKED FLUSH HINGE**

**TECHNICAL DATA**

ITEM CODE	SIZE	LENGTH	WIDTH	THICKNESS	SCREW NO.	WT/ PAIR	PRS. IN INNER	PRS. IN OUTER	PRS. IN PALLET
MHIN0118050	2"	51	40	1.2	4	0.040	25	400	20000

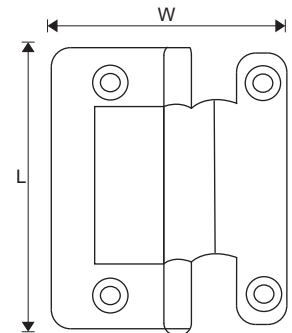
FINISH AVAILABLE - SC, BZP, ARJUNA, YPZP, EB, EXB, EXW, CP, SNP,  
ANTIQUE BRASS , DUROSIL



**115 : MILD STEEL CRANKED FLUSH HINGE**

**TECHNICAL DATA**

ITEM CODE	SIZE	LENGTH	WIDTH	THICKNESS	SCREW NO.	WT/ PAIR	PRS. IN INNER	PRS. IN OUTER	PRS. IN PALLET
MHIN0115050	2"	50	40	1.2	5	0.045	25	400	20000

FINISH AVAILABLE - SC, BZP, ARJUNA, YPZP, EB, EXB, EXW, CP, SNP,  
ANTIQUE BRASS , DUROSIL

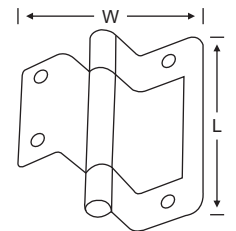
Note : Also available in Finial pins ( Code 105 FLP) Rounded corners ( Code 105 RC )  
and Rounded corners with Finial Pins ( 105 RCF)

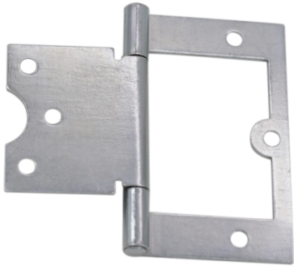

**105EFH ELONGATED FLUSH HINGE**

**TECHNICAL DATA**

ITEM CODE	SIZE	LENGTH	WIDTH	THICKNESS	SCREW NO.	WT/ PAIR	PRS. IN INNER	PRS. IN OUTER	PRS. IN PALLET
MHIN105E075	3"	75	80	1.5	6	0.106	25	200	9000

FINISH AVAILABLE - SC, BZP, ARJUNA, YPZP, EB, EXB, EXW, CP, SNP, ANTIQUE BRASS , DUROSIL

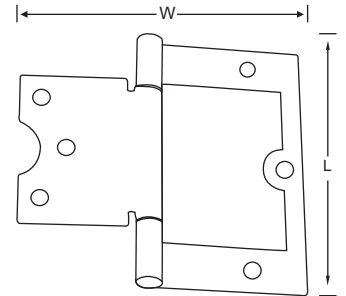
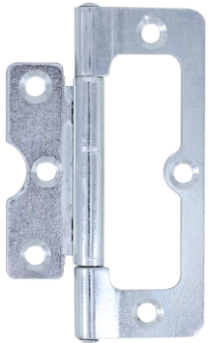
Note : Also available in Finial pins ( Code 105 FLP) Rounded corners ( Code 105 RC ) and Rounded corners with Finial Pins ( 105 RCF)

**104FP : MILD STEEL HURLINGE, RADIUS CORNER CRANKED KNUCKLE, FIXED PIN**

**TECHNICAL DATA**

ITEM CODE	SIZE	LENGTH	WIDTH	THICKNESS	SCREW NO.	WT/ PAIR	PRS. IN INNER	PRS. IN OUTER	PRS. IN PALLET
MHIN1041050	2"	50	34	1.2	4	0.032	25	600	27000
MHIN1041065	2.5"	60	38	1.2	6	0.042	25	500	20000
MHIN1041075	3"	76	51	1.5	7	0.096	25	225	9000
MHIN1041100	4"	101	63	2.0	8	0.180	10	100	4000

FINISH AVAILABLE - SC, BZP, ARJUNA, YPZP, EB, EXB, EXW, CP, SNP, ANTIQUE BRASS , DUROSIL

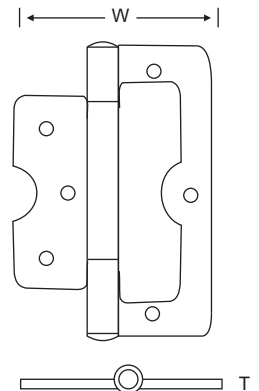
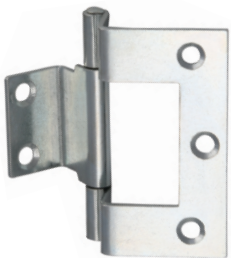
Note : Also available in Removable Pin ( Code 104 LP)

**106 : MILD STEEL CABINET HINGES FIXED PIN**

**TECHNICAL DATA**

ITEM CODE	SIZE	LENGTH	WIDTH	THICKNESS	SCREW NO.	WT/ PAIR	PRS. IN INNER	PRS. IN OUTER	PRS. IN PALLET
MHIN0106065	2.5"	63	60	1.5	6	0.092	25	200	9600
MHIN0106100	4"	100	62	1.5	7	0.140	20	160	6080

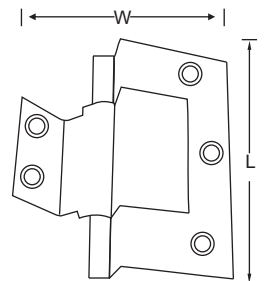
FINISH AVAILABLE - SC, BZP, ARJUNA, YPZP, EB, EXB, EXW, CP, SNP, ANTIQUE BRASS , DUROSIL





**108 : MILD STEEL CRANKED (EASY HANG) HINGE FIXED PIN**

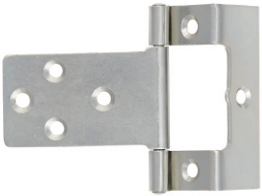

**TECHNICAL DATA**

ITEM CODE	SIZE	LENGTH	WIDTH	THICKNESS	SCREW NO.	WT/ PAIR	PRS. IN INNER	PRS. IN OUTER	PRS. IN PALLET
MHINO108050	2"	51	72	1.2	4	0.060	25	400	14400

FINISH AVAILABLE - SC, BZP, ARJUNA, YPZP, EB, EXB, EXW, CP, SNP, ANTIQUE BRASS, DUROSIL

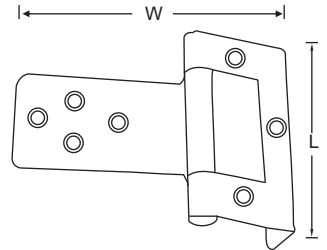

**109 : MILD STEEL DOUBLE CRANKED HINGE FIXED PIN**

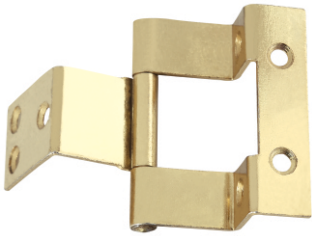

**TECHNICAL DATA**

ITEM CODE	SIZE	LENGTH	WIDTH	THICKNESS	SCREW NO.	WT/ PAIR	PRS. IN INNER	PRS. IN OUTER	PRS. IN PALLET
MHINO109060	2.5"	60	90	1.6	7	0.115	5	150	6750

FINISH AVAILABLE - SC, BZP, ARJUNA, YPZP, EB, EXB, EXW, CP, SNP, ANTIQUE BRASS, DUROSIL

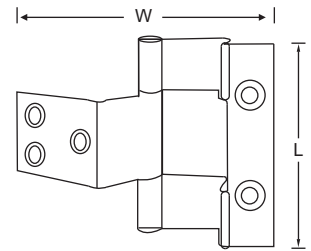

**1386 : MILD STEEL FANCY CABINET HINGE (BUTTERFLY)**



**TECHNICAL DATA**

ITEM CODE	SIZE	LENGTH	WIDTH	THICKNESS	SCREW NO.	WT/ PAIR	PRS. IN INNER	PRS. IN OUTER	PRS. IN PALLET
MHIN1386042	1.75"	42	34	1.0	4	0.014	50	1200	54000
MHIN1386051	2"	51	41	1.0	4	0.022	50	1000	40000

FINISH AVAILABLE - SC, BZP, ARJUNA, YPZP, EB, EXB, EXW, CP, SNP, ANTIQUE BRASS, DUROSIL

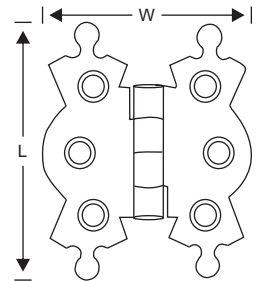

**1387 : MILD STEEL SEAT HINGE**

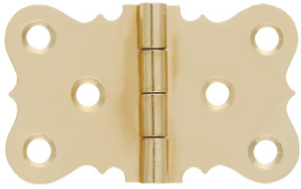

**TECHNICAL DATA**

ITEM CODE	SIZE	LENGTH	WIDTH	THICKNESS	SCREW NO.	WT/PAIR	PRS. IN INNER	PRS. IN OUTER	PRS. IN PALLET
MHIN1387064	1.5"	38	64	1.0	4	0.044	20	300	16200

FINISH AVAILABLE - SC, BZP, ARJUNA, YPZP, EB, EXB, EXW, CP, SNP, ANTIQUE BRASS, DUROSIL

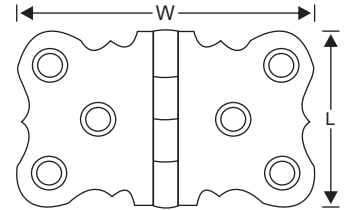

**1841 : MILD STEEL BUTT HINGES CRANKED KNUCKLE FIXED / REMOVABLE PIN ( AUSTRALIAN SPECIFICATION )**



**TECHNICAL DATA**

ITEM CODE	SIZE	LENGTH	WIDTH	THICKNESS	SCREW NO.	WT/PAIR	PRS. IN INNER	PRS. IN OUTER	PRS. IN PALLET
MHIN1841070	2.75"	70	50	1.6	8	0.125	10	200	6800
MHIN1841085	3.5"	85	61	1.7	8	0.180	10	100	4500

FINISH AVAILABLE - SC, BZP, ARJUNA, YPZP, EB, EXB, EXW, CP, SNP, ANTIQUE BRASS, DUROSIL

Also available - Loose pin (Code 452 DS/LP)

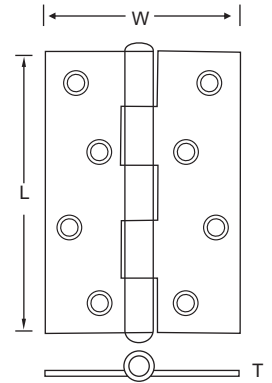

**1842 : MILD STEEL BUTT HINGES UNCRANKED KNUCKLE, FIXED PIN (FRENCH SPECIFICATION )**

**TECHNICAL DATA**

ITEM CODE	SIZE	LENGTH	WIDTH	THICKNESS	SCREW NO.	WT/PAIR	PRS. IN INNER	PRS. IN OUTER	PRS. IN PALLET
MHIN1842025	1"	25	18	1.0	2	0.009	50	2000	88000
MHIN1842030	1"	30	19	1.0	2	0.012	50	1500	66000
MHIN1842035	1.25"	35	22	1.0	4	0.016	50	1200	54000
MHIN1842040	1.5"	40	25	1.0	4	0.024	50	800	32000
MHIN1842050	2"	50	30	1.0	4	0.032	25	600	24000
MHIN1842060	2.5"	60	35	1.0	4	0.044	25	400	20000
MHIN1842070	2.75"	70	40	1.2	6	0.076	25	250	11250
MHIN1842080	3"	80	45	1.2	7	0.104	25	200	6000
MHIN1842090	3.5"	90	45	1.5	7	0.144	25	150	6000
MHIN1842100	4"	100	50	1.5	7	0.164	25	100	5000

FINISH AVAILABLE - SC, BZP, ARJUNA, YPZP, EB, EXB, EXW, CP, SNP, ANTIQUE BRASS, DUROSIL  
(Also available - In Brass & Stainless Steel)

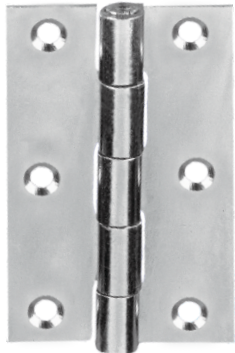
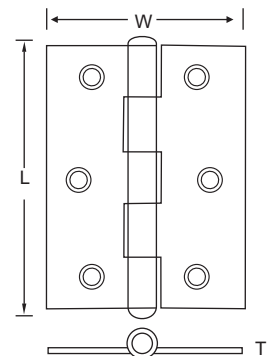

**804 : MILD STEEL SQUARE BUTT HINGES UNCRANKED KNUCKLE, FIXED PIN ( FRENCH SPECIFICATION)**

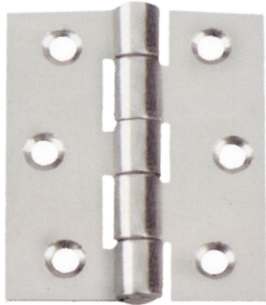

**TECHNICAL DATA**

ITEM CODE	LENGTH	WIDTH	THICKNESS	SCREW NO.	WT/ PAIR	PRS. IN INNER	PRS. IN OUTER	PRS. IN PALLET
MHIN0804030	30	30	1.0	4	0.018	50	1000	44000
MHIN0804040	40	40	1.0	4	0.033	50	600	24000
MHIN0804050	50	50	1.0	6	0.048	25	400	16000
MHIN0804060	60	60	1.00	6	0.076	25	250	11250
MHIN0804070	70	70	1.20	7	0.120	25	150	6000
MHIN0804080	80	80	1.20	7	0.144	25	150	6000

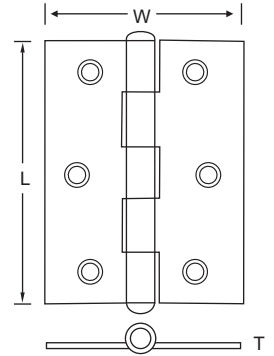

FINISH AVAILABLE - SC, BZP, ARJUNA, YPZP, EB, EXB, EXW, CP, SNP,  
ANTIQUE BRASS , DUROSIL  
Note : Also available in Brass & Stainless Steel

**36 : MILD STEEL CONTAINER HINGE**



**TECHNICAL DATA**

ITEM CODE	SIZE	LENGTH	WIDTH	THICKNESS	SCREW NO.	WT/ PAIR	PRS. IN INNER	PRS. IN OUTER	PRS. IN PALLET
MHIN0036180	7"	180	50	4.0	12	0.615	5	50	1000

FINISH AVAILABLE - SC, BZP, ARJUNA, YPZP, EB, EXB, EXW, CP, SNP,  
ANTIQUE BRASS , DUROSIL

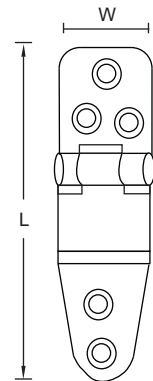

**101 : MILD STEEL CONTINUOUS PIANO HINGE (UNCRANKED KNUCKLE, FLUSH PIN)**



**TECHNICAL DATA**

WIDTH	THICKNESS	LENGTH (MM)	SCREW NO.	FINISH AVAILABLE
25,32,40,50	0.60	UPTO 2130	4	ZPEB,NPEXBR
25,32,40,50	0.60	UPTO 3500 ZPYP	4	ZP,ZPYP,EB
25,32,35,40,50	0.80	UPTO 2130	4	ZP,NP,OXD,EB,
30,35,40,50	1.20	UPTO 2130	6	ZP,NP,OXD,EB
40,50,60,75	1.60	UPTO 2130	6	ZP,NP,OXD,EB

Notes: Also Available (i) Undrilled piano hinges(codes 101A )  
(ii) Stainless steel ( Codes 101 SS & 101ASS )  
(iii) Steel Cranked Piano Hinges with 12mm gap (Code 101CR)  
AVAILABLE IN SOLID BRASS



## Cabinet Hinges

CABINET HINGE  
SPRUNG, 26 MM



GF0111

CABINET HINGE  
UNSPRUNG, 26 MM



GF0101

CABINET HINGE  
SPRUNG, 35 MM

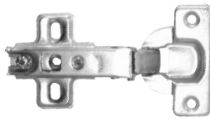

GF0112

CABINET HINGE  
UNSPRUNG, 35 MM



GF0102

SURFACE MOUNT  
SPRUNG HINGE, 100MM

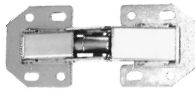

GF0201

CABINET HINGE  
SPRUNG, 170 DEGREE

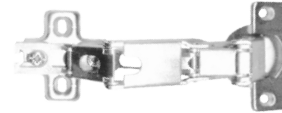

GF0151

CLIP ON CABINET  
HINGE 35MM  
90 DEGREE

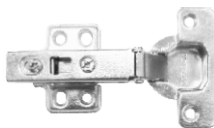

GF0115

CLIP ON CABINET  
HINGE SPRUNG,  
170 DEGREE

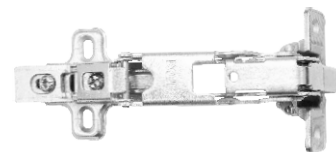

GF0155

Hydraulic Cabinet Hinge  
35mm 0 Degree



GF0113

Hydraulic Cabinet Hinge  
35mm 8 Degree



GF0114

Hydraulic Cabinet Hinge  
35mm 15 Degree



GF0117

SCREW No.	FINISH	PRS IN INNER	PRS IN OUTER
6	Nickel / ZP Plate	5	100

**BRASS EXTRUDED BUTT HINGES**

**TECHNICAL DATA**



DPG CODE	SIZE	ITEM CODE	LENGTH	WIDTH	THICKNESS	SCREW NO.	WT/ PAIR	PRS. IN INNER	PRS. IN OUTER	PRS. IN PALLET
GB1200	1"	BHIN1200025	25	19	1.4	4	0.015	10	1000	52000
GB1200	1.5"	BHIN1200038	38	22	1.4	4	0.024	10	600	27000
GB1200	2"	BHIN1200050	50	29	1.4	4	0.044	10	400	13600
GB1200	2.5"	BHIN1200063	64	35	1.4	4	0.070	10	300	9900
GB1200	3"	BHIN1200075	75	40	1.5	6	0.096	10	160	6720
GB1200	4"	BHIN1200100	100	60	2.0	7	0.230	5	75	3150
GB1203	5"	BHIN1200125	125	100	3.0	8	0.710	5	25	1250

FINISH AVAILABLE - S/C, POLISHED & LACQUERED BRASS/CP/SNP

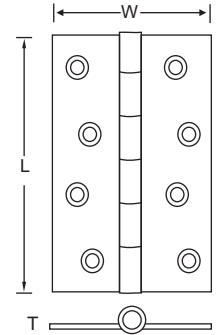

**TECHNICAL DATA**

DPG CODE	SIZE	ITEM CODE	LENGTH	WIDTH	THICKNESS	SCREW NO.	WT/ PAIR	PRS. IN INNER	PRS. IN OUTER	PRS. IN PALLET
GB1200	2"	BHIN1205050	50	32	1.4	4	0.052	10	300	10200
GB1200	3"	BHIN1206075	75	40	1.65	6	0.104	10	100	6000
GB1200	4"	BHIN1209100	100	66	2.0	8	0.267	5	75	3200

FINISH AVAILABLE - S/C, POLISHED & LACQUERED BRASS/CP/SNP

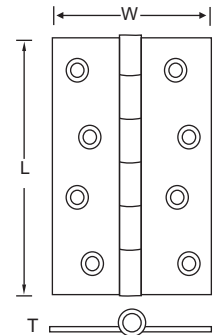

**TECHNICAL DATA**

DPG CODE	SIZE	ITEM CODE	LENGTH	WIDTH	THICKNESS	SCREW NO.	WT/ PAIR	PRS. IN INNER	PRS. IN OUTER	PRS. IN PALLET
GB1200	3"	BHIN1207075	75	40	2.0	7	0.120	10	100	6000
GB1201	4"	BHIN1201100	100	75	2.5	8	0.364	5	50	2250

FINISH AVAILABLE - S/C, POLISHED & LACQUERED BRASS/CP/SNP

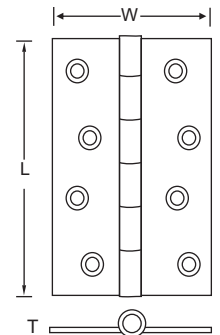

**TECHNICAL DATA**

DPG CODE	SIZE	ITEM CODE	LENGTH	WIDTH	THICKNESS	SCREW NO.	WT/ PAIR	PRS. IN INNER	PRS. IN OUTER	PRS. IN PALLET
GB1208	3"	BHIN1208075	75	50	2.0	7	0.156	10	75	4500
GB1210	4"	BHIN1210100	100	75	3.0	8	0.440	5	40	2000
GB1211	4"	BHIN1211076	76	50	2.2	7	0.165	5	75	4500

FINISH AVAILABLE - S/C, POLISHED & LACQUERED BRASS/CP/SNP

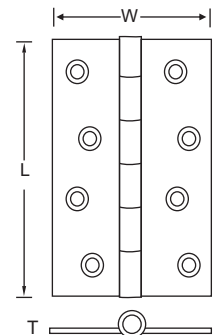



**BRASS BUTT HINGES, WITH DOUBLE STEEL WASHERS (DSW)**



**TECHNICAL DATA**

DPG CODE	SIZE	ITEM CODE	LENGTH	WIDTH	THICKNESS	SCREW NO.	WT/ PAIR	PRS. IN INNER	PRS. IN OUTER	PRS. IN PALLET
GB1300	3"	BHIN1300075	76	50	2.0	7	0.160	10	100	4000
GB1300	4"	BHIN1300100	100	67	2.0	8	0.270	5	60	2400

FINISH AVAILABLE - S/C,POLISHED & LACQUERED BRASS/CP/SNP

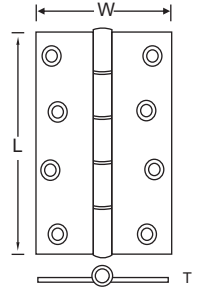

**TECHNICAL DATA**

DPG CODE	SIZE	ITEM CODE	LENGTH	WIDTH	THICKNESS	SCREW NO.	WT/ PAIR	PRS. IN INNER	PRS. IN OUTER	PRS. IN PALLET
GB1300	4"	BHIN1301100	100	67	3.0	8	0.360	5	40	2080
GB1301	3"	BHIN1301075	75	50	2.5	8	0.190	10	100	4000
GB1306	4"	BHIN1306100	100	76	2.0	8	0.310	05	60	2400

FINISH AVAILABLE - S/C,POLISHED & LACQUERED BRASS/CP/SNP

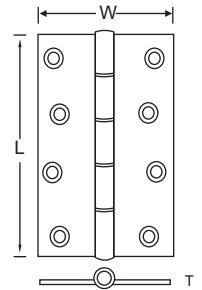

**TECHNICAL DATA**

DPG CODE	SIZE	ITEM CODE	LENGTH	WIDTH	THICKNESS	SCREW NO.	WT/ PAIR	PRS. IN INNER	PRS. IN OUTER	PRS. IN PALLET
GB1311	4"	BHIN1311100	100	67	3.5	10	0.454	5	25	1500
GB1303	4"	BHIN1303100	100	75	4.0	10	0.540	5	25	1500

FINISH AVAILABLE - S/C,POLISHED & LACQUERED BRASS/CP/SNP

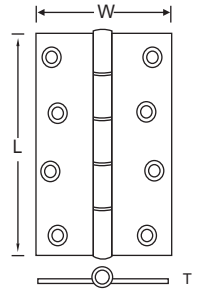

**TECHNICAL DATA**

DPG CODE	SIZE	ITEM CODE	LENGTH	WIDTH	THICKNESS	SCREW NO.	WT/ PAIR	PRS. IN INNER	PRS. IN OUTER	PRS. IN PALLET
GB1302	4"	BHIN1302100	100	75	3.0	8	0.440	5	80	2080
GB1304	5"	BHIN1304125	125	75	3.0	8	0.530	5	40	1600

FINISH AVAILABLE -S/C, POLISHED & LACQUERED BRASS/CP/SNP

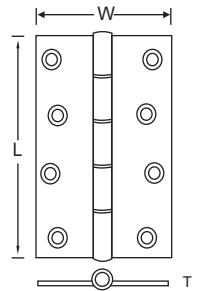

**TECHNICAL DATA**

DPG CODE	SIZE	ITEM CODE	LENGTH	WIDTH	THICKNESS	SCREW NO.	WT/ PAIR	PRS. IN INNER	PRS. IN OUTER	PRS. IN PALLET
GB1305	5"	BHIN1305125	125	75	2.5	8	0.430	5	40	2000

FINISH AVAILABLE - S/C,POLISHED & LACQUERED BRASS/CP/SNP

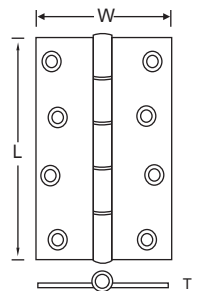

**PHOSPORUS BRONZE WASHERED BRASS BUTT HINGE (DPBW)**

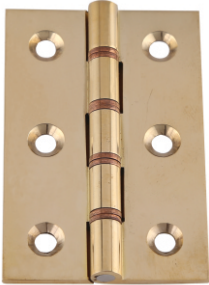

**TECHNICAL DATA**

DPG CODE	SIZE	ITEM CODE	LENGTH	WIDTH	THICKNESS	SCREW NO.	WT/ PAIR	PRS. IN INNER	PRS. IN OUTER	PRS. IN PALLET
GB1350	3"	BHIN1350075	76	51	2.5	8	0.200	10	100	4000
GB1350	4"	BHIN1350100	101	67	3.5	10	0.444	5	40	1600

FINISH AVAILABLE - S/C,POLISHED & LACQUERED BRASS/CP/SNP

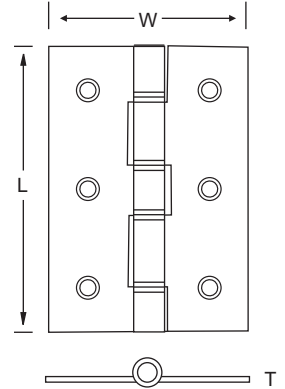

**DOUBLE PHOSPORUS BRONZE WASHERED BRASS BUTT HINGE (RADIUS CONER) DPBW**



**TECHNICAL DATA**

DPG CODE	SIZE	ITEM CODE	LENGTH	WIDTH	THICKNESS	SCREW NO.	WT/ PAIR	PRS. IN INNER	PRS. IN OUTER	PRS. IN PALLET
GB1380	3"	BHIN1380075	75	51	2.5	10	0.200	5	100	4000
GB1385	4"	BHIN1385100	102	67	2.5	8	0.320	5	40	2000
GB1386	4"	BHIN1386100	102	67	3.0	10	0.380	5	40	1800
GB1387	4"	BHIN1387100	102	76	3.0	10	0.430	5	40	1600

FINISH AVAILABLE -S/C, POLISHED & LACQUERED BRASS/CP/SNP

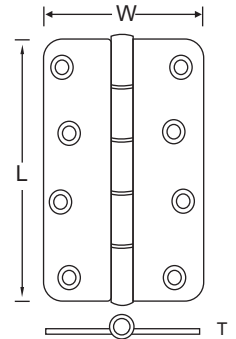

**BRASS BUTT HINGES WITH TWO/FOUR BALL BEARING AND BUTTON TIP HEAD(S.S. PIN)**



**TECHNICAL DATA**

DPG CODE	SIZE	ITEM CODE	LENGTH	WIDTH	THICKNESS	SCREW NO.	WT/ PAIR	PRS. IN INNER	PRS. IN OUTER	PRS. IN PALLET
GB1401	3"	BHIN1401075	75	65	3.0	10	0.340	5	50	2000
GB1402	4"	BHIN1402100	100	75	2.5	8	0.390	5	50	2000
GB1406	5"	BHIN1406125	125	90	5.0	10	1.200	5	15	600

FINISH AVAILABLE -S/C, POLISHED & LACQUERED BRASS/CP/SNP

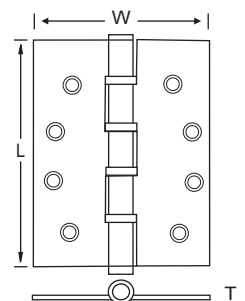

## BRASS SQUARE BUTT HINGES

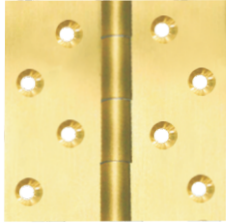

### TECHNICAL DATA

DPG CODE	SIZE	ITEM CODE	LENGTH	WIDTH	THICKNESS	SCREW NO.	WT/ PAIR	PRS. IN INNER	PRS. IN OUTER	PRS. IN PALLET
GB1351	1.5"	BHIN1351040	38	38	1.5	4	0.052	10	200	12000
GB1352	2"	BHIN1352050	50	50	1.5	4	0.092	10	160	8000
GB1353	2.5"	BHIN1353065	63	63	1.8	6	0.164	10	100	5000
GB1354	3.5"	BHIN1354090	87	87	2.0	6	0.340	5	50	2000
GB1355	4"	BHIN1355100	100	100	3.0	8	0.600	2	30	1200

FINISH AVAILABLE - S/C, POLISHED & LACQUERED BRASS/CP/SNP

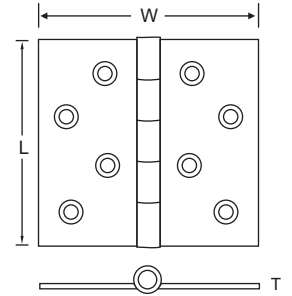

## BRASS SQUARE BUTT HINGES WITH DOME HEAD PIN

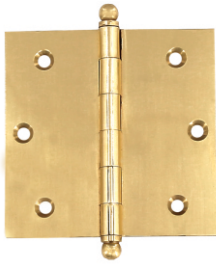

### TECHNICAL DATA

DPG CODE	SIZE	ITEM CODE	LENGTH	WIDTH	THICKNESS	SCREW NO.	WT/ PAIR	PRS. IN INNER	PRS. IN OUTER	PRS. IN PALLET
GB1500	1.5"	BHIN1500040	38	38	1.5	4	0.060	10	200	12000
GB1500	2"	BHIN1500050	50	50	1.6	6	0.103	10	160	6400
GB1500	2.5"	BHIN1500065	63	63	2.0	6	0.180	10	100	4000
GB1500	3.5"	BHIN1500090	89	89	2.2	6	0.360	5	50	2000
GB1500	4"	BHIN1500100	100	100	3.0	8	0.620	2	30	1200

FINISH AVAILABLE - S/C, POLISHED & LACQUERED BRASS/CP/SNP

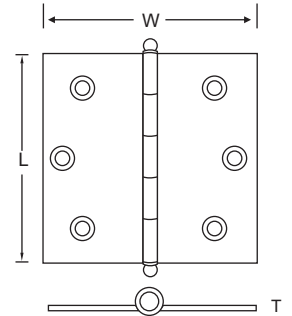

## BRASS BUTT HINGES WITHOUT BALL BEARING AND TOMB HEAD ( S.S. PIN)



### TECHNICAL DATA

DPG CODE	SIZE	ITEM CODE	LENGTH	WIDTH	THICKNESS	SCREW NO.	WT/ PAIR	PRS. IN INNER	PRS. IN OUTER	PRS. IN PALLET
GB1501	3.5"	BHIN1501090	90	90	2.5	7	0.460	5	40	1600
GB1502	4"	BHIN1502100	100	90	2.5	7	0.540	5	40	1400

FINISH AVAILABLE - S/C, POLISHED & LACQUERED BRASS/CP/SNP

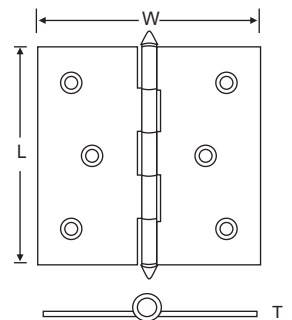

**BRASS BUTT HINGES WITH TWO/FOUR BALL BEARING AND BUTTON TIP HEAD(S.S. PIN)**



**TECHNICAL DATA**

DPG CODE	SIZE	ITEM CODE	LENGTH	WIDTH	THICKNESS	SCREW NO.	WT/ PAIR	PRS. IN INNER	PRS. IN OUTER	PRS. IN PALLET
GB1405	4"	BHIN1405100	100	100	3.0	10	0.770	5	25	1000

FINISH AVAILABLE - S/C,POLISHED & LACQUERED BRASS/CP/SNP

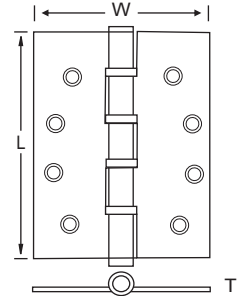

**BRASS BUTT HINGES WITH TWO/FOUR BALL BEARING AND BUTTON TIP HEAD(S.S. PIN)**



**TECHNICAL DATA**

DPG CODE	SIZE	ITEM CODE	LENGTH	WIDTH	THICKNESS	SCREW NO.	WT/ PAIR	PRS. IN INNER	PRS. IN OUTER	PRS. IN PALLET
GB1403	4"	BHIN1403100	100	90	2.5	10	0.520	5	40	1600

FINISH AVAILABLE - S/C,POLISHED & LACQUERED BRASS/CP/SNP

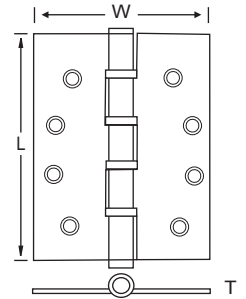

**BRASS BUTT HINGES WITH TWO/FOUR BALL BEARING AND BUTTON TIP HEAD(S.S. PIN)**



**TECHNICAL DATA**

DPG CODE	SIZE	ITEM CODE	LENGTH	WIDTH	THICKNESS	SCREW NO.	WT/ PAIR	PRS. IN INNER	PRS. IN OUTER	PRS. IN PALLET
GB1404	4"	BHIN1404100	100	75	3.0	10	0.560	5	25	1200

FINISH AVAILABLE - S/C,POLISHED & LACQUERED BRASS/CP/SNP

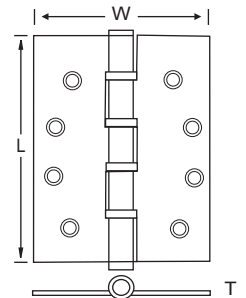

**BRASS REFLECT HINGES ( HANDED ) ( S.S. PIN )**



**TECHNICAL DATA**

DPG CODE	SIZE	ITEM CODE	LENGTH	WIDTH	THICKNESS	SCREW NO.	WT/ PAIR	PRS. IN INNER	PRS. IN OUTER	PRS. IN PALLET
GB1801	4"	BHIN1801100	100	70	3.0	8	0.450	5	40	1600

FINISH AVAILABLE - S/C,POLISHED & LACQUERED BRASS/CP/SNP

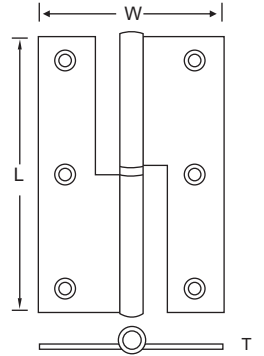

**BRASS REFLECT HINGES WITH FLAT FLUSH / ROUND HEAD ( S.S. PIN )**



**TECHNICAL DATA**

DPG CODE	SIZE	ITEM CODE	LENGTH	WIDTH	THICKNESS	SCREW NO.	WT/ PAIR	PRS. IN INNER	PRS. IN OUTER	PRS. IN PALLET
GB1901	2.5"	BHIN1901065	65	48	2.0	7	0.150	10	100	5000
GB1902	3"	BHIN1902075	75	50	2.0	7	0.180	10	100	4000
GB1903	3.5"	BHIN1903090	90	55	2.8	8	0.310	5	50	2500

FINISH AVAILABLE - S/C,POLISHED & LACQUERED BRASS/CP/SNP

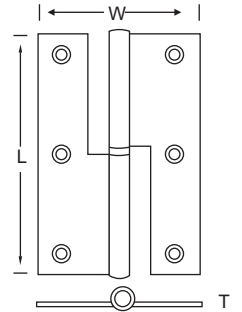

**BRASS " H " HINGES WITH ROUND HEAD**

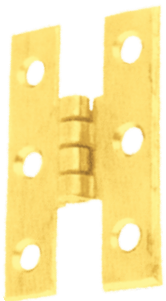

**TECHNICAL DATA**

DPG CODE	SIZE	ITEM CODE	LENGTH	SCREW NO.	WT/ PAIR	PRS. IN INNER	PRS. IN OUTER	PRS. IN PALLET
GB2098	2"	BHIN2098050	50	6	0.040	10	500	20000
GB2099	2.5"	BHIN2099065	65	6	0.060	10	250	12500
GB2100	3"	BHIN2100075	75	6	0.070	10	250	10000
GB2101	3.5"	BHIN2101090	90	6	0.080	10	200	8000

FINISH AVAILABLE - S/C,POLISHED & LACQUERED BRASS/CP/SNP

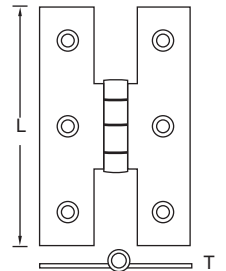



**BRASS BUTT HINGES WITH TWO BALL BEARING AND FINIAL HEAD ( S.S. PIN)**



**TECHNICAL DATA**

DPG CODE	SIZE	ITEM CODE	LENGTH	WIDTH	THICKNESS	SCREW NO.	WT/ PAIR	PRS. IN INNER	PRS. IN OUTER	PRS. IN PALLET
GB1601	4"	BHIN1601100	100	75	3.0	8	0.540	5	40	1200
GB1602	4"	BHIN1602100	100	90	3.0	8	0.620	5	30	1200

FINISH AVAILABLE - S/C,POLISHED & LACQUERED BRASS/CP/SNP

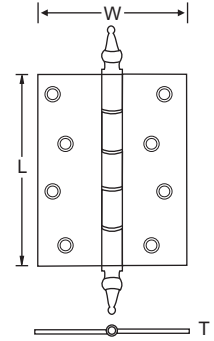

**BRASS BUTT HINGES WITH ACRON TIP (S.S. PIN)**



**TECHNICAL DATA**

DPG CODE	SIZE	ITEM CODE	LENGTH	WIDTH	THICKNESS	SCREW NO.	WT/ PAIR	PRS. IN INNER	PRS. IN OUTER	PRS. IN PALLET
GB2201	3"	BHIN2201080	80	60	2.5	6	0.270	5	60	2400

FINISH AVAILABLE - S/C,POLISHED & LACQUERED BRASS/CP/SNP

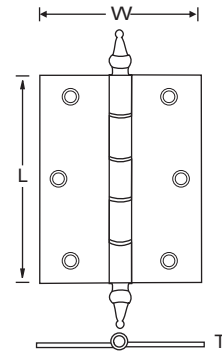

**BRASS BUTT HINGES WITH TWO BALL BEARING AND DOUBLE SECURITY PIN**

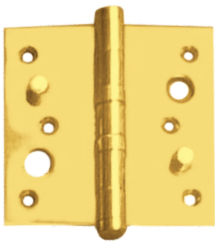

**TECHNICAL DATA**

DPG CODE	SIZE	ITEM CODE	LENGTH	WIDTH	THICKNESS	SCREW NO.	WT/ PAIR	PRS. IN INNER	PRS. IN OUTER	PRS. IN PALLET
GB1701	3.5"	BHIN1701090	90	90	2.8	8	0.540	5	40	1440

FINISH AVAILABLE - S/C,POLISHED & LACQUERED BRASS/CP/SNP

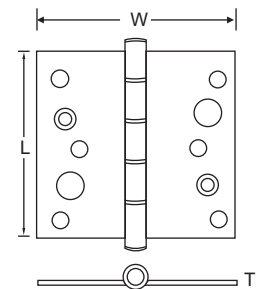

**BRASS BUTT HINGES WITH RADIUS CORNER, ROUND HEAD**

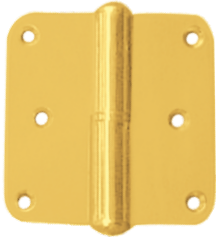

**TECHNICAL DATA**

DPG CODE	SIZE	ITEM CODE	LENGTH	WIDTH	THICKNESS	SCREW NO.	WT/ PAIR	PRS. IN INNER	PRS. IN OUTER	PRS. IN PALLET
GB2302	3"	BHIN2302080	80	80	3.0	8	0.450	5	40	1600

FINISH AVAILABLE - S/C,POLISHED & LACQUERED BRASS/CP/SNP

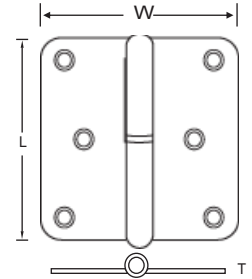

**BRASS CRANKED HINGES WITH TWO BALL BEARING, BUTTON TIP HEAD (S.S. PIN)**



**TECHNICAL DATA**

DPG CODE	SIZE	ITEM CODE	LENGTH	WIDTH	THICKNESS	SCREW NO.	WT/ PAIR	PRS. IN INNER	PRS. IN OUTER	PRS. IN PALLET
GB2400	2.5"	BHIN2400063	63	58	1.7	6	0.195	10	100	4000
GB2401	4"	BHIN2401100	100	80	3.0	8	0.660	5	30	1200

FINISH AVAILABLE - S/C,POLISHED & LACQUERED BRASS/CP/SNP

NOTE : 2.5" IS WITHOUT BALL BEARING

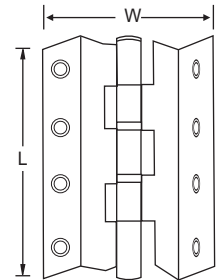

**GB3152 BRASS COUNTER FLAP HINGE**

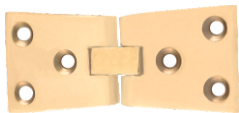

**TECHNICAL DATA**

DPG CODE	SIZE	ITEM CODE	LENGTH	WIDTH	THICK.	SCREW NO.	WT/ PAIR	PRS. IN INNER	PRS. IN OUTER	PRS. IN PALLET
GB3152	1.25"X3"	BHIN3152032	32	77	3	7	0.140	10	100	5000
GB3152	1.5"X4"	BHIN3152038	37	103	3	7	0.230	5	80	3200

FINISH AVAILABLE - S/C,POLISHED & LACQUERED BRASS/CP/SNP

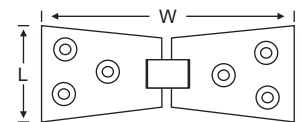

**GB3210 : BRASS PARLIAMENT HINGES**

**TECHNICAL DATA**

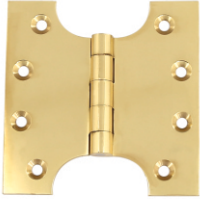

DPG CODE	SIZE	ITEM CODE	LENGTH	WIDTH	THICKNESS	SCREW NO.	WT/ PAIR	PRS. IN INNER	PRS. IN OUTER	PRS. IN PALLET
GB3210	4"X2"	BHIN3210050	100x50	100	3.0	10	0.460	5	25	1500
GB3210	4"X3"	BHIN3210075	100x75	125	3.0	10	0.600	5	20	1200
GB3210	4"X4"	BHIN3210100	100x100	150	3.0	10	0.726	2	12	840
GB3210	4"X5"	BHIN3210125	100x125	175	3.0	10	0.834	2	12	840
GB3210	4"X6"	BHIN3210150	100x150	200	3.0	10	0.900	2	12	840

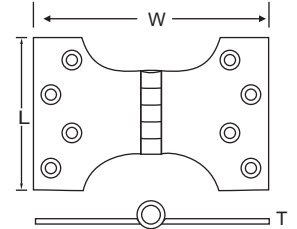

FINISH AVAILABLE - S/C,POLISHED & LACQUERED BRASS/CP/SNP

**GB3210A : BRASS PARLIAMENT HINGES**

**TECHNICAL DATA**

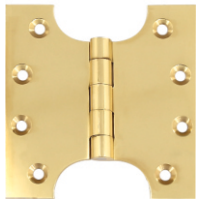

DPG CODE	SIZE	ITEM CODE	LENGTH	WIDTH	THICKNESS	SCREW NO.	WT/ PAIR	PRS. IN INNER	PRS. IN OUTER	PRS. IN PALLET
GB3210A	4"X2"	BHIN3211050	100x50	100	4.0	10	0.640	4	20	1000
GB3210A	4"X3"	BHIN3211075	100x75	125	4.0	10	0.800	4	16	800
GB3210A	4"X4"	BHIN3211100	100x100	150	4.0	10	0.968	4	4	800
GB3210A	4"X5"	BHIN3211125	100x125	175	4.0	10	1.112	4	4	640
GB3210A	4"X5"	BHIN3211150	100x150	200	4.0	10	1.184	4	4	640

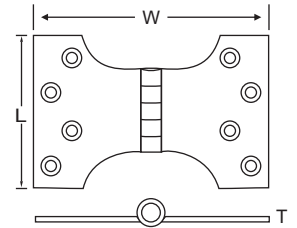

FINISH AVAILABLE - S/C,POLISHED & LACQUERED BRASS/CP/SNP

**BRASS CONTINUOUS PIANO HINGES UNCRANKED KNUCKLE, FLUSH PIN**



**TECHNICAL DATA**

DPG CODE	SIZE	ITEM CODE	LENGTH	WIDTH	THICKNESS	PRS. IN INNER	PRS. IN OUTER
GB0101	UP TO 7"	BHIN0101XXX	Up to 2000	25,32,50	0.6	10	50

FINISH AVAILABLE - S/C,POLISHED & LACQUERED BRASS/CP/SNP



**BRASS REFLUX HINGE**



**TECHNICAL DATA**

DPG CODE	SIZE	ITEM CODE	LENGTH	SCREW NO.	WT/ SET	SET. IN INNER	SET. IN OUTER	SET. IN PALLET
GB1811	2.5"	BHIN1811065	65	6	0.065	10	200	11200

FINISH AVAILABLE - S/C,POLISHED & LACQUERED BRASS/CP/SNP

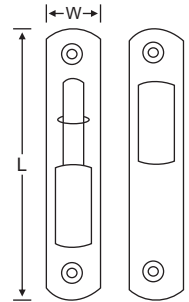

**BRASS SNAKE HINGE**



**TECHNICAL DATA**

DPG CODE	SIZE	ITEM CODE	LENGTH	WIDTH	THICKNESS	SCREW NO.	WT/ PAIR	PRS. IN INNER	PRS. IN OUTER	PRS. IN PALLET
GB2451	2.5"	BHIN2451063	65	50	3.0	6	0.080	10	200	11200

FINISH AVAILABLE - S/C, POLISHED & LACQUERED BRASS, ANTIQUE BRASS, CP, SNP

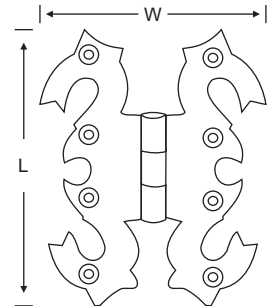

**MG1302 : EXTRA MALLEABLE ANTIQUE BUTTERFLY HINGE**



**TECHNICAL DATA**

ITEM CODE	SIZE	LENGTH	WIDTH	THICKNESS	SCREW NO.	WT/ PAIR	PRS. IN INNER	PRS. IN OUTER	PRS. IN PALLET
MHIN1302075	3"	71	48	2.5	5	0.122	10	100	6000

FINISH AVAILABLE - SC, BZP, ARJUNA, YPZP, EB, EXB, EXW, CP, SNP, ANTIQUE BRASS , DUROSIL

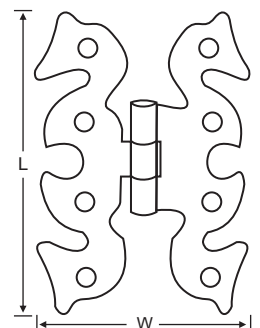

**G1302 BLACK ANTIQUE BUTTERFLY HINGE**



**TECHNICAL DATA**

DPG CODE	ITEM CODE	SIZE	LENGTH	WIDTH	SCREW NO.	WT/PAIR	PAIR IN INNER	PAIR IN OUTER	PAIR IN PALLET
G1302	CHIN1302070	3"	70	46	6	0.116	20	320	6080

FINISH AVAILABLE : EXB, DUROSIL

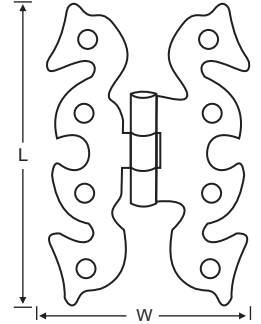

**CAST BUTT HINGE**

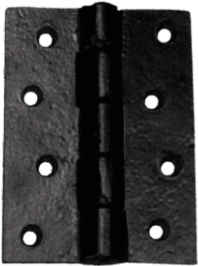

**TECHNICAL DATA**

DPG CODE	ITEM CODE	SIZE	LENGTH	WIDTH	SCREW NO.	WT/PAIR	PRS. IN INNER	PRS. IN OUTER	PRS. IN PALLET
G1297	CHIN1297050	2"	51	43	8	0.146	20	120	5400
G1298	CHIN1298065	2.5"	65	46	8	0.200	20	80	3600
G1299	CHIN1299075	3"	76	52	8	0.290	20	60	2880
G1301	CHIN1301100	4"	103	58	8	0.400	10	40	1800

FINISH AVAILABLE : SC & EXB

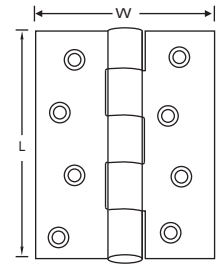

**G0206 : BLACK ANTIQUE UNEQUAL HINGE**



**TECHNICAL DATA**

ITEM CODE	SIZE	LENGTH	WIDTH	SCREW NO.	WT/PAIR	PRS. IN INNER	PRS. IN OUTER	PRS. IN PALLET
CHIN0206090	3.5"	105	86	7	0.302	10	50	2400

Finish Available - EXB

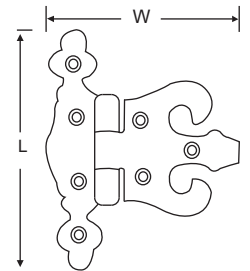



**121A : MILD STEEL LIGHT TEE HINGE UNCRANKED KNUCKLE, FIXED PIN**

**TECHNICAL DATA**

ITEM CODE	SIZE	LENGTH	WIDTH	THICKNESS	SCREW NO.	WT/ PAIR	PRS. IN INNER	PRS. IN OUTER	PRS. IN PALLET
MHINO119075	3"	79	60	1.2	6	0.062	10	200	10000
MHINO119100	4"	104	67	1.2	6	0.089	10	200	9000
MHINO119150	6"	151	70	1.4	6	0.147	10	150	4800
MHINO119200	8"	201	80	1.4	6	0.184	10	100	4000
MHINO119225	9"	227	80	1.4	6	0.200	10	100	3200
MHINO119250	10"	253	80	1.4	6	0.216	10	80	3120
MHINO119300	12"	303	89	1.6	6	0.356	10	50	1750

FINISH AVAILABLE - SC, BZP, ARJUNA, YPZP, JAPD, EXB, DUROSIL

Note : Also available With Brass or Stainless Steel Pin.

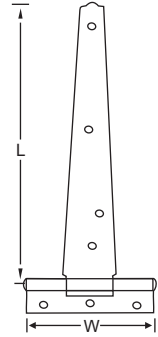
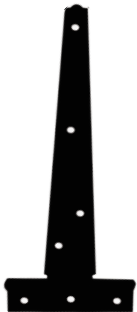
**119P : MILD STEEL LIGHT TEE PREMIUM UNCRANKED KNUCKLE, FIXED PIN**

**TECHNICAL DATA**

ITEM CODE	SIZE	LENGTH	WIDTH	THICKNESS	SCREW NO.	WT/ PAIR	PRS. IN INNER	PRS. IN OUTER	PRS. IN PALLET
MHINP119100	4"	100	66	1.6	6	0.100	10	200	9000
MHINP119150	6"	153	70	1.6	6	0.165	10	120	4800
MHINP119200	8"	200	80	1.6	6	0.230	10	80	4000
MHINP119225	9"	231	76	1.6	6	0.260	10	80	2560
MHINP119250	10"	248	76	1.6	6	0.284	10	60	2340

FINISH AVAILABLE - SC, BZP, ARJUNA, JAPD, EXB, DUROSIL

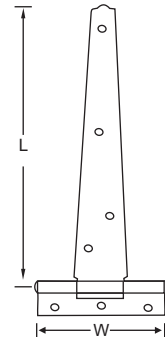
Note : Also available With Brass or Stainless Steel Pin.



**121M : MILD STEEL MEDIUM TEE HINGE UNCRANKED KNUCKLE, FIXED PIN**

**TECHNICAL DATA**

ITEM CODE	SIZE	LENGTH	WIDTH	THICKNESS	SCREW NO.	WT/ PAIR	PRS. IN INNER	PRS. IN OUTER	PRS. IN PALLET
MHINO120250	10"	255	89	1.85	8	0.350	5	50	1950
MHINO120300	12"	305	100	1.85	8	0.430	5	40	1440
MHINO120350	14"	355	115	1.85	8	0.570	5	35	980
MHINO120375	15"	380	115	1.85	8	0.610	5	30	1020
MHINO120400	16"	405	125	2.20	10	0.864	5	20	720
MHINO120450	18"	455	130	2.20	10	0.968	5	20	600
MHINO120500	20"	505	150	2.25	12	1.264	5	15	480
MHINO120600	24"	605	150	2.25	12	1.436	5	10	360

FINISH AVAILABLE - SC, BZP, ARJUNA, YPZP, JAPD, EXB, HSG, DUROSIL

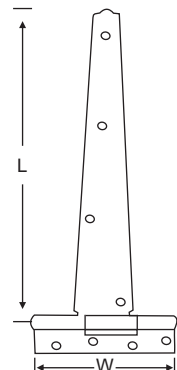
Note : Also available With Brass or Stainless Steel Pin.



**120P : MILD STEEL PREMIUM MEDIUM TEE HINGE UNCRANKED KNUCKLE, FIXED PIN**

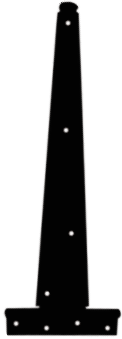

**TECHNICAL DATA**

ITEM CODE	SIZE	LENGTH	WIDTH	THICKNESS	SCREW NO.	WT/ PAIR	PRS. IN INNER	PRS. IN OUTER	PRS. IN PALLET
MHINP120300	12"	305	100	1.9	8	0.510	5	40	1440
MHINP120350	14"	351	114	1.9	8	0.630	5	30	1080
MHINP120375	15"	384	114	1.9	10	0.640	5	30	1020
MHINP120400	16"	410	124	2.5	10	0.960	10	10	720
MHINP120450	18"	465	140	2.5	10	1.110	10	10	600

**FINISH AVAILABLE - SC, BZP, ARJUNA, YPZP, JAPD, EXB, HSG, DUROSIL**

Note : Also available With Brass or Stainless Steel Pin.

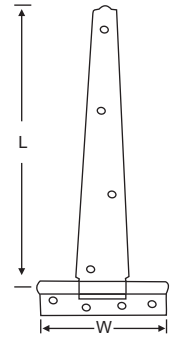

**121H : MILD STEEL HEAVY TEE HINGE UNCRANKED KNUCKLE, FIXED PIN**



**TECHNICAL DATA**

ITEM CODE	SIZE	LENGTH	WIDTH	THICKNESS	SCREW NO.	WT/ PAIR	PRS. IN INNER	PRS. IN OUTER	PRS. IN PALLET
MHIN0122100	4"	102	90	2.4	9	0.334	5	50	2000
MHIN0122150	6"	152	90	2.4	9	0.390	5	50	2000
MHIN0122200	8"	200	100	2.4	9	0.490	5	40	1600
MHIN0122250	10"	250	100	2.4	10	0.568	5	35	1260
MHIN0122300	12"	303	100	2.5	10	0.614	5	30	1200
MHIN0122350	14"	350	100	2.5	10	0.690	5	25	1000
MHIN0122400	16"	408	140	2.5	10	1.170	5	15	600
MHIN0122450	18"	452	150	3.0	12	1.185	5	5	540
MHIN0122500	20"	510	165	3.0	12	1.920	5	5	450
MHIN0122600	24"	612	165	3.0	12	2.120	5	5	320

**FINISH AVAILABLE - SC, BZP, ARJUNA, YPZP, JAPD, EXB, HSG, DUROSIL**

Note : Also available With Brass or Stainless Steel Pin.

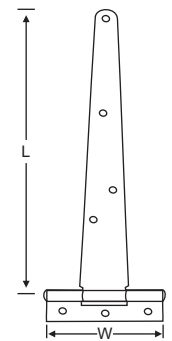

**120 : MILD STEEL STRONG TEE HINGE UNCRANKED KNUCKLE, FIXED PIN**



**TECHNICAL DATA**

ITEM CODE	SIZE	LENGTH	WIDTH	THICKNESS	SCREW NO.	WT/ PAIR	PRS. IN INNER	PRS. IN OUTER	PRS. IN PALLET
MHIN1120150	6"	155	89	2.0	8	0.312	5	50	2000
MHIN1120200	8"	205	100	2.4	10	0.454	5	40	1600
MHIN1120250	10"	255	102	2.4	10	0.510	5	35	1260
MHIN1120300	12"	303	115	2.4	10	0.650	5	30	1200
MHIN1120350	14"	356	128	2.4	10	0.880	5	20	800
MHIN1120400	16"	408	140	2.5	10	1.140	5	15	600
MHIN1120450	18"	460	150	3.0	12	1.516	5	5	450
MHIN1120500	20"	510	165	3.0	12	1.800	5	5	450
MHIN1120600	24"	617	165	3.0	12	2.140	5	5	320

**FINISH AVAILABLE - SC, BZP, ARJUNA, YPZP, JAPD, EXB, HSG, DUROSIL**

Note : Also available With Brass or Stainless Steel Pin.

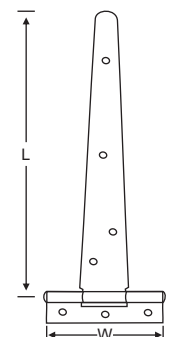

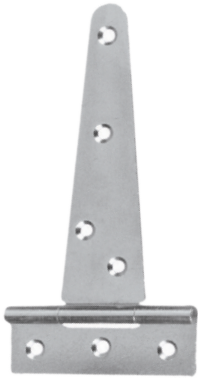
**119 : MILD STEEL SCOTCH TEE HINGE UNCRANKED KNUCKLE, FIXED PIN**

**TECHNICAL DATA**

ITEM CODE	SIZE	LENGTH	WIDTH	THICKNESS	SCREW NO.	WT/ PAIR	PRS. IN INNER	PRS. IN OUTER	PRS. IN PALLET
MHIN1119100	4"	100	83	2.5	10	0.320	5	50	2000
MHIN1119150	6"	152	90	2.5	10	0.430	5	40	1600
MHIN1119200	8"	200	102	3.0	10	0.660	5	30	990
MHIN1119250	10"	258	115	3.0	12	0.900	5	20	720
MHIN1119300	12"	303	126	3.0	12	1.100	5	5	600
MHIN1119350	14"	357	140	3.4	12	1.674	5	5	400
MHIN1119400	16"	406	145	3.4	12	1.720	5	5	400

FINISH AVAILABLE - SC, BZP, ARJUNA, YPZP, JAPD, EXB, HSG, DUROSIL

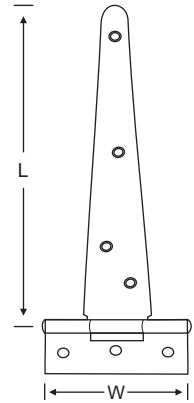
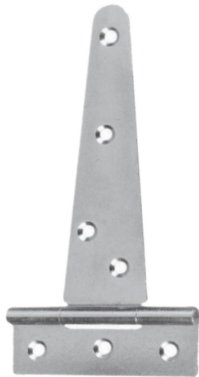
Note : Also available With Brass or Stainless Steel Pin.

**868 : MILD STEEL HEAVY SCOTCH TEE HINGE UNCRANKED KNUCKLE, FIXED PIN**

**TECHNICAL DATA**

ITEM CODE	SIZE	LENGTH	WIDTH	THICKNESS	SCREW NO.	WT/ PAIR	PRS. IN INNER	PRS. IN OUTER	PRS. IN PALLET
MHIN0868100	4"	102	90	2.5	9	0.334	5	50	2000
MHIN0868150	6"	152	90	2.5	9	0.390	5	50	2000
MHIN0868200	8"	200	100	2.5	9	0.486	5	40	1600
MHIN0868250	10"	250	100	2.5	10	0.568	5	35	1260
MHIN0868300	12"	303	100	2.8	10	0.768	5	25	1000
MHIN0868350	14"	350	145	3.0	12	1.490	5	10	450
MHIN0868375	15"	382	145	3.0	12	1.600	2	10	360
MHIN0868400	16"	405	145	3.0	12	1.622	2	10	360
MHIN0868450	18"	455	177	3.15	12	2.010	2	10	320
MHIN0868500	20"	505	177	3.0	12	2.460	2	8	320
MHIN0868600	24"	610	177	3.3	12	2.726	2	6	240

FINISH AVAILABLE - SC, BZP, ARJUNA, YPZP, JAPD, EXB, HSG, DUROSIL,

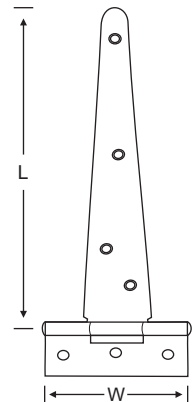
Note : Also available With Brass or Stainless Steel Pin



**867 : MILD STEEL EXTRA STRONG WEIGHTY TEE HINGE UNCRANKED KNUCKLE, FIXED PIN**

**TECHNICAL DATA**

ITEM CODE	SIZE	LENGTH	WIDTH	THICKNESS	SCREW NO.	WT/ PAIR	PRS. IN INNER	PRS. IN OUTER	PRS. IN PALLET
MHIN0867100	4"	101	90	2.8	9	0.410	5	50	1500
MHIN0867150	6"	150	90	2.8	9	0.500	5	40	1200
MHIN0867200	8"	200	100	3.0	10	0.650	5	30	900
MHIN0867250	10"	250	115	3.0	10	0.794	5	25	900
MHIN0867300	12"	302	127	3.0	10	0.982	5	20	800

FINISH AVAILABLE - SC, BZP, ARJUNA, YPZP, JAPD, EXB, HSG, DUROSIL

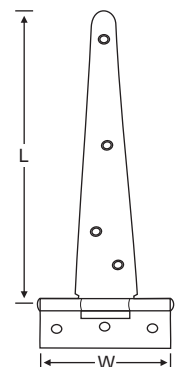
Note : Also available With Brass or Stainless Steel Pin.



**910 : MILD STEEL GRADED TEE HINGE**



**TECHNICAL DATA**

ITEM CODE	SIZE	LENGTH	WIDTH	THICKNESS	SCREW NO.	WT/ PAIR	PRS. IN INNER	PRS. IN OUTER	PRS. IN PALLET
MHIN0910100	4"	102	80	2.0	8	0.240	5	60	2700
MHIN0910150	6"	150	90	2.20	8	0.340	5	40	2000
MHIN0910225	9"	230	100	2.5	10	0.566	5	30	1080
MHIN0910250	10"	250	100	2.5	10	0.546	5	30	1080
MHIN0910300	12"	300	120	2.5	12	0.776	5	20	800
MHIN0910375	15"	375	140	3.0	12	1.278	5	5	500
MHIN0910450	18"	450	170	3.0	12	1.864	5	5	350
MHIN0910600	24"	600	200	3.0	12	2.986	2	2	200

FINISH AVAILABLE - SC, BZP, ARJUNA, YPZP, JAPD, EXB, HSG, DUROSIL

Note : Also available With Brass or Stainless Steel Pin.

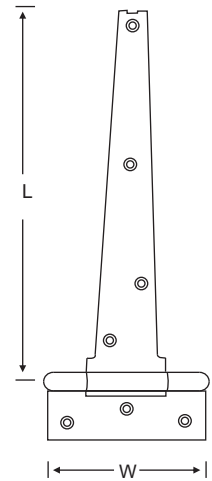

**950 : MILD STEEL STRAP HINGE UNCRANKED KNUCKLE**



**TECHNICAL DATA**

ITEM CODE	SIZE	LENGTH	WIDTH	THICKNESS	SCREW NO.	WT/ PAIR	PRS. IN INNER	PRS. IN OUTER	PRS. IN PALLET
MHIN0950100	4"	102	35	1.5	6	0.121	10	150	5400
MHIN0950150	6"	150	44	1.9	8	0.310	10	70	2520
MHIN0950200	8"	205	44	2.0	8	0.402	5	50	2000

FINISH AVAILABLE - SC, BZP, ARJUNA, YPZP, JAPD, EXB, HSG, DUROSIL

Note : Also available With Brass or Stainless Steel Pin.

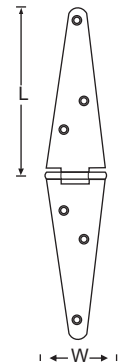

**30 : MILD STEEL STRAP HINGE UNCRANKED KNUCKLE ( MEDIUM WEIGHT)**



**TECHNICAL DATA**

ITEM CODE	SIZE	LENGTH	WIDTH	THICKNESS	SCREW NO.	WT/ PAIR	PRS. IN INNER	PRS. IN OUTER	PRS. IN PALLET
MHIN0030250	10"	259	63	2.6	10	0.938	5	20	720
MHIN0030300	12"	305	63	2.8	10	1.236	5	10	600

FINISH AVAILABLE - SC, BZP, ARJUNA, YPZP, JAPD, EXB, HSG, DUROSIL

Note : Also available With Brass or Stainless Steel Pin.

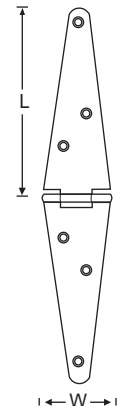

**234 : MILD STEEL GATE HOLD BACK HINGE / PENTURE DE GONDS ( FRENCH SPECIFICATION)**

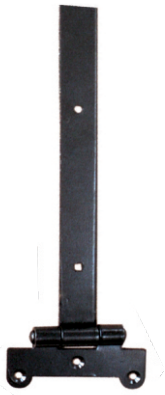

**TECHNICAL DATA**

ITEM CODE	SIZE	LENGTH	WIDTH	THICKNESS	SCREW NO.	WT/ PAIR	PRS. IN INNER	PRS. IN OUTER	PRS. IN PALLET
MGFI0234300	12"	300	112	4.0	10	0.520	10	40	1600
MGFI0234400	16"	400	112	4.0	10	0.620	10	30	1200
MGFI0234500	20"	500	112	4.0	10	0.700	10	30	1080
MGFI0234600	24"	600	112	4.0	10	0.800	5	25	900

FINISH AVAILABLE - SC,BZP, ARJUNA, EXB,JAPD,HSG, DUROSIL

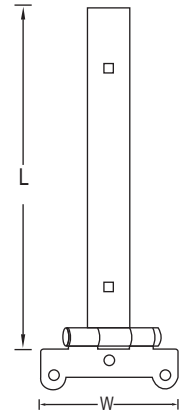

**1055 : MILD STEEL HOOK AND BAND HINGE (STRAIGHT)**



**TECHNICAL DATA**

ITEM CODE	SIZE	LENGTH	WIDTH	THICKNESS	SCREW NO.	WT/ PAIR	PRS. IN INNER	PRS. IN OUTER	PRS. IN PALLET
MGFI1055250	10"	254	38	4	12	1.381	2	14	630
MGFI1055300	12"	305	38	4	12	1.552	2	12	540
MGFI1055350	14"	355	45	4	12	1.860	2	8	400
MGFI1055400	16"	407	45	4	12	2.036	2	8	384
MGFI1055450	18"	458	48	4.5	12	2.848	1	6	270
MGFI1055500	20"	508	48	4.5	12	3.028	1	6	192
MGFI1055600	24"	610	48	4.8	12	3.664	1	3	162
MGFI1055750	30"	760	57	5	12	5.428	1	3	120
MGFI1055900	36"	914	63	5	12	6.700	1	2	84
MGFI1055142	42"	1065	69	5	12	8.300	1	1	60
MGFI1055148	48"	1220	69	5	12	10.700	1	1	60

FINISH AVAILABLE - SC,BZP, ARJUNA,EXB,JAPD,HSG,DUROSIL

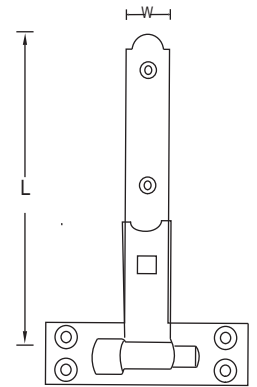

**128 : MILD STEEL PREMIUM HOOK AND BAND HINGE (STRAIGHT)**



**TECHNICAL DATA**

ITEM CODE	SIZE	LENGTH	WIDTH	THICKNESS	SCREW NO.	WT/ PAIR	PRS. IN INNER	PRS. IN OUTER	PRS. IN PALLET
MGFI0128250	10"	255	38	4.8	12	1.475	2	14	630
MGFI0128300	12"	305	38	4.8	12	1.710	2	12	540
MGFI0128350	14"	357	38	4.8	12	1.800	2	8	400
MGFI0128400	16"	404	38	4.8	12	1.860	2	8	384
MGFI0128450	18"	460	50	4.8	12	3.160	1	6	270
MGFI0128500	20"	512	50	4.8	12	3.280	1	6	192
MGFI0128600	24"	610	56	4.8	12	4.580	1	3	162
MGFI0128750	30"	761	56	5.4	12	5.160	1	3	120
MGFI0128900	36"	915	56	5.4	12	6.300	1	2	84

FINISH AVAILABLE - SC,BZP,ARJUNA, EXB,JAPD,HSG,DUROSIL

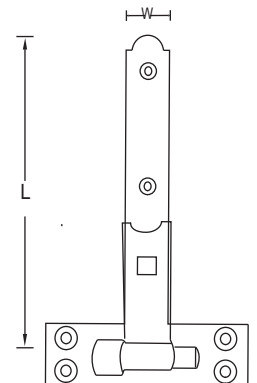



**1056 : MILD STEEL HOOK AND BAND HINGE (CRANKED)**

**TECHNICAL DATA**



ITEM CODE	SIZE	LENGTH	WIDTH	THICKNESS	SCREW NO.	WT/ PAIR	PRS. IN INNER	PRS. IN OUTER	PRS. IN PALLET
MGFI1056250	10"	254	38	4	12	1.381	2	14	630
MGFI1056300	12"	305	38	4	12	1.552	2	12	540
MGFI1056350	14"	355	45	4	12	1.860	2	8	400
MGFI1056400	16"	407	45	4	12	2.036	2	8	384
MGFI1056450	18"	458	48	4.5	12	2.848	1	6	270
MGFI1056500	20"	508	48	4.5	12	3.028	1	6	192
MGFI1056600	24"	610	48	4.8	12	3.664	1	3	162
MGFI1056750	30"	760	57	5	12	5.428	1	3	120
MGFI1056900	36"	914	63	5	12	6.700	1	2	84
MGFI1056142	42"	1065	69	5	12	8.300	1	1	60
MGFI1056148	48"	1220	69	5	12	10.700	1	1	60

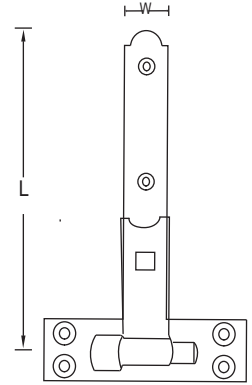

FINISH AVAILABLE - SC,BZP,ARJUNA, EXB,JAPD,HSG,DUROSIL

**130 : MILD STEEL PREMIUM HOOK AND BAND HINGE (CRANKED)**

**TECHNICAL DATA**



ITEM CODE	SIZE	LENGTH	WIDTH	THICKNESS	SCREW NO.	WT/ PAIR	PRS. IN INNER	PRS. IN OUTER	PRS. IN PALLET
MGFI0130250	10"	255	38	4.8	12	1.475	2	14	630
MGFI0130300	12"	305	38	4.8	12	1.710	2	12	540
MGFI0130350	14"	357	38	4.8	12	1.800	2	8	400
MGFI0130400	16"	404	38	4.8	12	1.860	2	8	384
MGFI0130450	18"	460	50	4.8	12	3.160	1	6	270
MGFI0130500	20"	512	50	4.8	12	3.280	1	6	192
MGFI0130600	24"	610	56	4.8	12	4.580	1	3	162
MGFI0130750	30"	761	56	5.4	12	5.160	1	3	120
MGFI0130900	36"	915	56	5.4	12	6.300	1	2	84

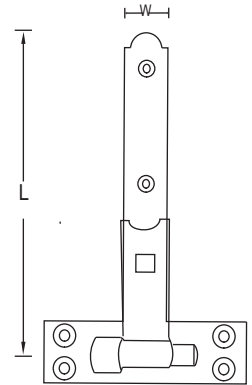

FINISH AVAILABLE - SC,BZP, ARJUNA,EXB,JAPD,HSG,DUROSIL

**1055L : MILD STEEL LIGHT HOOK AND BAND HINGE (STRAIGHT)**

**TECHNICAL DATA**



ITEM CODE	SIZE	LENGTH	WIDTH	THICKNESS	SCREW NO.	WT/ PAIR	PRS. IN INNER	PRS. IN OUTER	PRS. IN PALLET
MGFI1053250	10"	250	38	3.0	10	1.100	2	14	630
MGFI1053300	12"	300	38	3.0	12	1.200	2	14	630
MGFI1053350	14"	350	45	3.0	12	1.550	2	10	500
MGFI1053400	16"	400	45	3.0	12	1.620	2	10	460

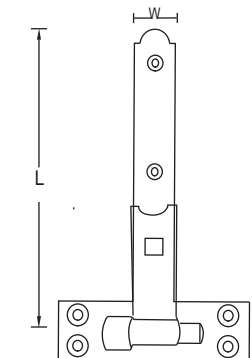

FINISH AVAILABLE - SC, BZP, ARJUNA,JAPD, EXB, HSG,DUROSIL

**1056L : MILD STEEL LIGHT HOOK AND BAND HINGE (CRANKED)**



**TECHNICAL DATA**

ITEM CODE	SIZE	LENGTH	WIDTH	THICKNESS	SCREW NO.	WT/ PAIR	PRS. IN INNER	PRS. IN OUTER	PRS. IN PALLET
MGFI1054250	10"	250	38	3.0	10	1.100	2	14	630
MGFI1054300	12"	300	38	3.0	12	1.200	2	14	630
MGFI1054350	14"	350	45	3.0	12	1.550	2	10	500
MGFI1054400	16"	400	45	3.0	12	1.620	2	10	460

FINISH AVAILABLE - SC, BZP, ARJUNA, JAPD, EXB, HSG, DUROSIL

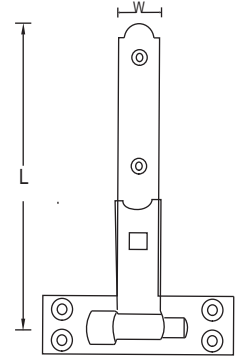

**1057 : MILD STEEL ADJUSTABLE HOOK AND BAND HINGE**



**TECHNICAL DATA**

ITEM CODE	SIZE	LENGTH	WIDTH	THICKNESS	SCREW NO.	WT/ PAIR	PRS. IN INNER	PRS. IN OUTER	PRS. IN PALLET
MGFI1057300	12"	300	45	4.0	12	3.000	1	4	260
MGFI1057450	18"	450	50	4.5	12	4.360	1	4	160
MGFI1057600	24"	600	50	5.0	12	5.040	1	3	162
MGFI1057750	30"	750	57	5.0	12	6.048	1	2	120
MGFI1057900	36"	900	63	5.0	12	7.552	1	2	70

FINISH AVAILABLE - SC, BZP, ARJUNA, EXB, HSG, DUROSIL

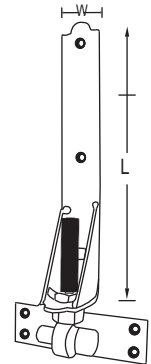

**499 : MILD STEEL REVERSIBLE HINGE WITH CAST IRON CUP**



**TECHNICAL DATA**

ITEM CODE	SIZE	LENGTH	WIDTH	THICKNESS	SCREW NO.	WT/ PAIR	PRS. IN INNER	PRS. IN OUTER	PRS. IN PALLET
MGFI0499250	10"	254	38	4.0	12	1.644	2	14	420
MGFI0499300	12"	305	38	4.0	12	1.804	2	12	360
MGFI0499350	14"	355	45	4.0	12	2.200	2	8	320
MGFI0499400	16"	407	45	4.0	12	2.364	2	8	320
MGFI0499450	18"	458	48	4.5	12	3.124	1	6	270
MGFI0499500	20"	508	48	4.5	12	3.424	1	6	192
MGFI0499600	24"	610	48	4.8	12	3.868	1	3	162
MGFI0499750	30"	760	57	5.0	12	5.260	1	3	120
MGFI0499900	36"	914	63	5.0	12	6.684	1	2	84

FINISH AVAILABLE - SC, BZP, ARJUNA, HSG, EXB, DUROSIL

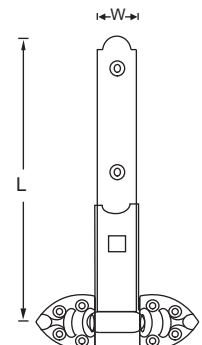

**499LW: MILD STEEL LIGHT WEIGHT REVERSIBLE HINGE WITH CAST IRON CUP**



**TECHNICAL DATA**

ITEM CODE	SIZE	LENGTH	WIDTH	THICKNESS	SCREW NO.	WT/ PAIR	PRS. IN INNER	PRS. IN OUTER	PRS. IN PALLET
MGFI0498300	12"	305	38	3.0	12	1.682	2	10	540
MGFI0498350	14"	355	43	3.0	12	1.704	2	10	500
MGFI0498400	16"	407	43	3.0	12	1.832	2	10	460
MGFI0498450	18"	458	43	3.0	12	1.904	2	10	360
MGFI0498500	20"	508	43	3.0	12	2.142	2	8	320
MGFI0498600	24"	610	43	3.0	12	2.570	2	8	288

FINISH AVAILABLE - SC, BZP, ARJUNA, HSG, EXB, DUROSIL

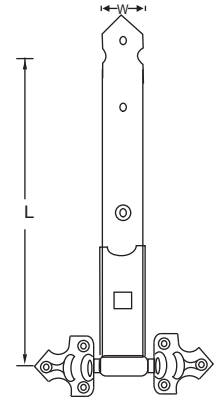

**1056C/D : MILD STEEL HOOK AND BAND (DECORATIVE SQUARE TAIL)**



**TECHNICAL DATA**

ITEM CODE	SIZE	LENGTH	WIDTH	THICKNESS	SCREW NO.	WT/ PAIR	PRS. IN INNER	PRS. IN OUTER	PRS. IN PALLET
MGFI1059250	10"	260	40	3.0	12	0.854	2	14	700
MGFI1059300	12"	310	40	3.0	12	0.950	2	12	540
MGFI1059400	16"	390	40	3.0	12	1.124	2	10	500
MGFI1059500	20"	515	40	3.0	12	1.310	2	6	480
MGFI1059600	24"	615	40	4.0	12	1.972	2	3	300
MGFI1059750	30"	750	40	4.0	12	2.282	2	3	300

FINISH AVAILABLE - SC, BZP, HSG, ARJUNA, EXB, DUROSIL

(Also Available 1055D Decorative)

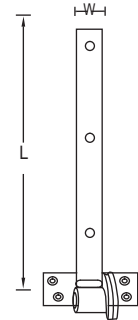

**7182 : MILD STEEL STATE PATTERN BAND**



**TECHNICAL DATA**

ITEM CODE	SIZE	LENGTH	WIDTH	THICKNESS	WT/ PCS	PCS. IN INNER	PCS. IN OUTER	PCS. IN PALLET
MGFI7182450	18"	450	57	5.0	1.270	4	12	504
MGFI7182500	20"	500	57	5.0	1.382	4	12	504

FINISH AVAILABLE - SC, BZP, ARJUNA, EXB, HSG, DUROSIL

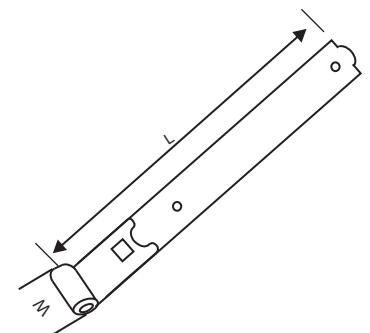

**1061 : MILD STEEL SHORT HINGES**



**TECHNICAL DATA**

ITEM CODE	SIZE	LENGTH	WIDTH	THICKNESS	WT/PCS	PCS. IN INNER	PCS. IN OUTER	PCS. IN PALLET
MGFI1061150	6"	151	40	8.0	0.518	10	30	1260
MGFI1061300	12"	308	40	8.0	0.908	10	20	800
MGFI1061450	18"	460	40	8.0	1.211	4	16	608

FINISH AVAILABLE - SC, BZP, ARJUNA, EXB, HSG, DUROSIL

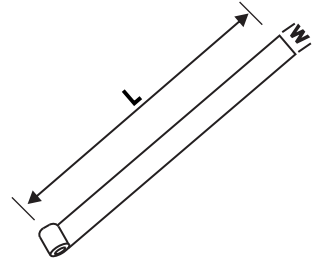

**1055H : HOOK ON BACK PLATE TO SUIT HOOK & BAND**



**TECHNICAL DATA**

ITEM CODE	SIZE	LENGTH	WIDTH	THICK.	PIN DIA	SCREW NO.	WT/PRS	PCS. IN INNER	PCS. IN OUTER	PCS. IN PALLET
MGFI1156012	10"&12"	134	38	4.0	12	12	0.522	5	30	1200
MGFI1156013	14"&16"	134	45	4.0	13	12	0.572	5	30	1200
MGFI1156016	18"&20"&24"	166	48	4.5	16	12	0.920	5	20	720
MGFI1156019	30"	200	57	5.0	19	12	1.556	2	10	400
MGFI1156020	36"	200	63	5.0	20	12	1.582	2	10	400

FINISH AVAILABLE - BZP, ARJUNA, EXB, HSG, DUROSIL

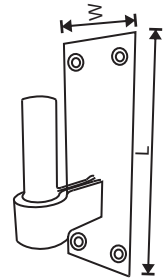

**112G : HOOK ON BACK PLATE TO SUIT ADJ. BAND**



**TECHNICAL DATA**

ITEM CODE	SIZE	LENGTH	WIDTH	THICK.	PIN DIA	SCREW NO.	WT/PRS	PRS. IN INNER	PRS. IN OUTER	PRS. IN PALLET
MGFI112G135	10", 14"&12"	135	45	4.0	16	12	0.748	5	30	1200
MGFI112G166	18"&20"&24"	166	50	5.0	19	12	1.062	5	20	1200
MGFI112G200	30"	200	57	5.0	19	12	1.556	2	10	400

FINISH AVAILABLE - BZP, ARJUNA, EXB, HSG, DUROSIL

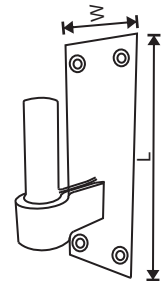

**499C : CUP ONLY FOR REVERSIBLE HINGE**

**TECHNICAL DATA**



ITEM CODE	SIZE	LENGTH	WIDTH	THICKNESS	HOLE DIA	SCREW NO.	WT/ SET	SET IN INN. BOX	SET IN OUT. SET	SET IN OUT. PALLET
MGFI499C012	10"&12"	51	50	6.5-7.5	12	10	0.500	4	24	1080
MGFI499C016	14"&16"	54	53	6.5-7.5	14	10	0.616	4	24	1080
MGFI499C019	18"&20"&24"	67	62	6.5-7.5	18	12	0.960	2	16	720
MGFI499C022	30"&36"	67	62	7.5-8.5	20	12	0.940	2	16	720

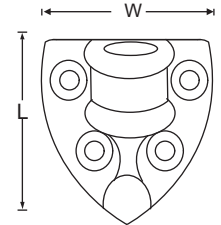

FINISH AVAILABLE - EXB, SC, HSG, DUROSIL  
 Remark : Supplied in set of 4 Pcs.

**GF0251 : MILD STEEL BARREL HINGE**



**TECHNICAL DATA**

ITEM CODE	SIZE	LENGTH	WIDTH	DIA	BOLT	WT/ SET	SET IN INNER	SET IN INNER	SET IN PALLET
MHIN0251XXX	1"	36	29	9.4	M6	0.024	50	500	30000

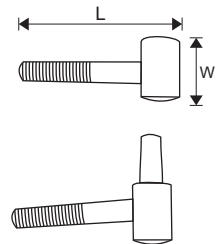

FINISH AVAILABLE - SC, BZP, ARJUNA, YPZP, EB

**38 : MILD STEEL BULLET HINGES**



**TECHNICAL DATA**

ITEM CODE	LENGTH	OUTAR DIA	WT/PCS	PCS IN INNER	PCS IN OUTER	PCS IN PALLET
MHIN3805010	50	10	0.030	50	1000	36000
MHIN3807012	70	12	0.060	50	400	18000
MHIN3807014	70	14	0.082	20	300	12000
MHIN3807016	70	16	0.103	20	200	9000
MHIN3807018	70	18	0.135	20	160	7200
MHIN3807020	70	20	0.170	20	140	5600
MHIN3810016	100	16	0.155	10	120	5400
MHIN3810020	100	20	0.250	10	80	4320
MHIN3810025	100	25	0.370	6	60	2520
MHIN3810030	120	30	0.650	4	32	1440

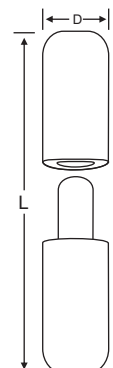

FINISH AVAILABLE - SC, ZP

### BLACK ANTIQUE SPEAR HINGE



#### TECHNICAL DATA

DPG CODE	ITEM CODE	SIZE	LENGTH	WIDTH	SCREW NO.	WT/ PCS	PCS. IN INNER	PCS. IN OUTER	PCS. IN PALLET
G0017	CHIN0017220	9"	200	106	8	0.203	10	80	3200
G0019	CHIN0019290	12"	270	112	8	0.264	10	60	3200

FINISH AVAILABLE : EXB, DUROSIL

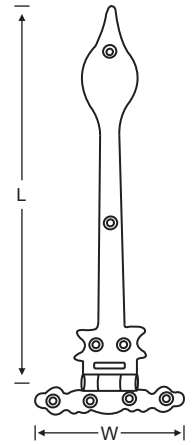

### BLACK ANTIQUE ORNATE HINGE



#### TECHNICAL DATA

DPG CODE	ITEM CODE	SIZE	LENGTH	WIDTH	SCREW NO.	WT/ PCS	PCS. IN INNER	PCS. IN OUTER	PCS. IN PALLET
G0201	CHIN0201150	6"	145	90	7	0.150	20	100	4000
G0202	CHIN0202225	9"	213	105	7	0.231	10	80	3600
G0201H	CHIN201H150	6"	142	92	7	0.158	20	100	4000
G0201EH	CHIN201E150	6"	142	92	7	0.235	20	100	3600
G0202H	CHIN202H225	9"	213	108	7	0.256	10	80	3200

FINISH AVAILABLE : EXB, DUROSIL

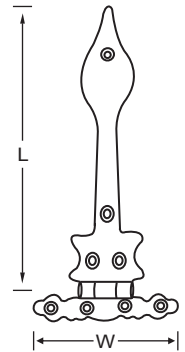

### BLACK ANTIQUE ORNATE CORONET HINGE



#### TECHNICAL DATA

DPG CODE	ITEM CODE	SIZE	LENGTH	WIDTH	SCREW NO.	WT/ PCS	PCS. IN INNER	PCS. IN OUTER	PCS. IN PALLET
G0205	CHIN0205300	12"	290	108	7	0.260	10	60	3000

FINISH AVAILABLE : EXB, DUROSIL

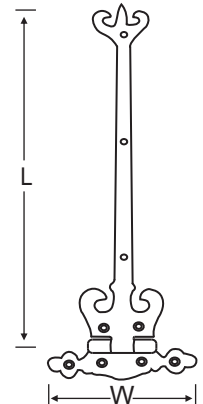



**BLACK ANTIQUE HEAVY PLAIN HINGE**



**TECHNICAL DATA**

DPG CODE	ITEM CODE	SIZE	LENGTH	WIDTH	SCREW NO.	WT/ PCS	PCS. IN INNER	PCS. IN OUTER	PCS. IN PALLET
G0208	CHIN0208375	16"	350	106	8	0.773	5	20	960
G0203H	CHIN203H225	9"	230	104	8	0.465	5	20	1600

FINISH AVAILABLE : EXB, DUROSIL

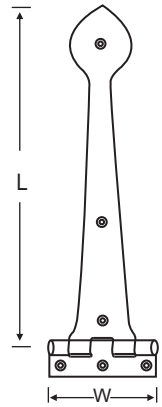

**BLACK ANTIQUE LIGHT PLAIN HINGE**



**TECHNICAL DATA**

DPG CODE	ITEM CODE	SIZE	LENGTH	WIDTH	SCREW NO.	WT/ PCS	PCS. IN INNER	PCS. IN OUTER	PCS. IN PALLET
G0005	CHIN0005310	12"	275	100	8	0.527	5	30	1200
G0007	CHIN0007390	16"	355	100	8	0.650	5	30	960
G0009	CHIN0009460	18"	450	100	8	0.738	5	20	960

FINISH AVAILABLE : EXB, DUROSIL

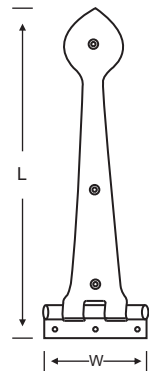

**BLACK ANTIQUE FLEUR - DE - LYS HINGE**



**TECHNICAL DATA**

DPG CODE	ITEM CODE	SIZE	LENGTH	WIDTH	SCREW NO.	WT/ PCS	PCS. IN INNER	PCS. IN OUTER	PCS. IN PALLET
G0011	CHIN0011310	12"	270	100	8	0.708	5	20	880
G0013	CHIN0013390	16"	360	100	8	0.893	5	20	720
G0015	CHIN0015460	18"	430	100	8	0.913	5	20	600

FINISH AVAILABLE : EXB, DUROSIL

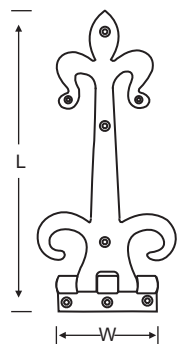

**BLACK ANTIQUE CLAW HINGE**



**TECHNICAL DATA**

DPG CODE	ITEM CODE	SIZE	LENGTH	WIDTH	SCREW NO.	WT/PCS	PCS. IN INNER	PCS. IN OUTER	PCS. IN PALLET
G0050	CHIN0050385	16"	362	100	8	0.700	5	20	960

FINISH AVAILABLE : EXB, DUROSIL

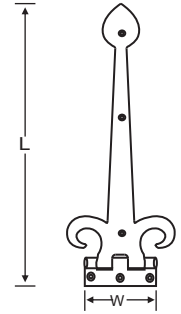

**BLACK ANTIQUE FLEUR - DE - LYS CLAW HINGE FRONT**



**TECHNICAL DATA**

DPG CODE	ITEM CODE	SIZE	LENGTH	WIDTH	SCREW NO.	WT/PCS	PCS. IN INNER	PCS. IN OUTER	PCS. IN PALLET
G0045	CHIN0045264	11"	275	150	8	0.610	5	30	1080
G0046	CHIN0046420	17"	428	150	8	0.680	5	20	960

FINISH AVAILABLE : EXB, DUROSIL

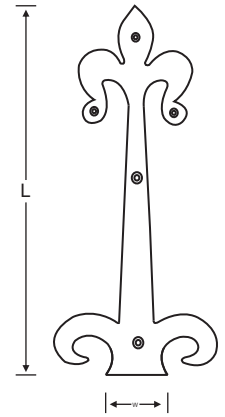

**BLACK ANTIQUE LIGHT HINGE FRONT**



**TECHNICAL DATA**

DPG CODE	ITEM CODE	SIZE	LENGTH	WIDTH	SCREW NO.	WT/PCS	PCS. IN INNER	PCS. IN OUTER	PCS. IN PALLET
G0047	CHIN0047263	11"	270	62	8	0.230	10	80	3200

FINISH AVAILABLE : EXB, DUROSIL

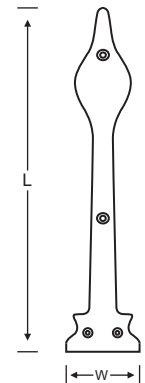

**BLACK ANTIQUE SPEAR HINGE FRONT**



**TECHNICAL DATA**

DPG CODE	ITEM CODE	SIZE	LENGTH	WIDTH	SCREW NO.	WT/ PCS	PCS. IN INNER	PCS. IN OUTER	PCS. IN PALLET
G0042	CHIN0042350	14"	355	50	8	0.450	10	40	1400
G0044	CHIN0044420	17"	420	58	8	0.550	5	30	1200

FINISH AVAILABLE : EXB, DUROSIL

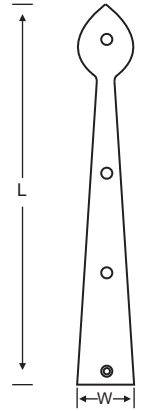

**BLACK ANTIQUE FLEUR - DE - LYS HINGE FRONT**



**TECHNICAL DATA**

DPG CODE	ITEM CODE	SIZE	LENGTH	WIDTH	SCREW NO.	WT/ PCS	PCS. IN INNER	PCS. IN OUTER	PCS. IN PALLET
G0020	CHIN0020406	16"	408	110	8	0.523	10	30	1200

FINISH AVAILABLE : EXB, EXW, DUROSIL

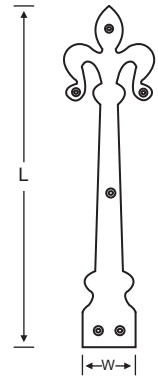

**BLACK ANTIQUE SPEAR HINGE FRONT WITH CLAW**



**TECHNICAL DATA**

DPG CODE	ITEM CODE	SIZE	LENGTH	WIDTH	SCREW NO.	WT/ PCS	PCS. IN INNER	PCS. IN OUTER	PCS. IN PALLET
G0040	CHIN0040385	16"	390	150	8	0.603	10	30	1080

FINISH AVAILABLE : EXB, EXW, DUROSIL

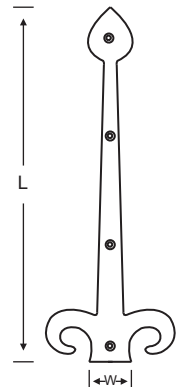



Note

1. \_\_\_\_\_
2. \_\_\_\_\_
3. \_\_\_\_\_
4. \_\_\_\_\_
5. \_\_\_\_\_
6. \_\_\_\_\_
7. \_\_\_\_\_
8. \_\_\_\_\_
9. \_\_\_\_\_
10. \_\_\_\_\_
11. \_\_\_\_\_
12. \_\_\_\_\_
13. \_\_\_\_\_
14. \_\_\_\_\_
15. \_\_\_\_\_
16. \_\_\_\_\_
17. \_\_\_\_\_
18. \_\_\_\_\_
19. \_\_\_\_\_
20. \_\_\_\_\_