



Garg



**FIELD GATE & FENCING HARDWARE**

Visit us at : [www.garglocks.com](http://www.garglocks.com)



**6002 : MILD STEEL FERRULE LOCKING STRAINER**



**TECHNICAL DATA**

ITEM CODE	LENGTH	WIDTH	THICKNESS	BOLT NO.	WT./PCS	PCS. IN INNER	PCS. IN OUTER
MMH6002090	90	53	2.6	M12	0.174	25	100

FINISH AVAILABLE : BZP, EXB, HSG, DUROSIL

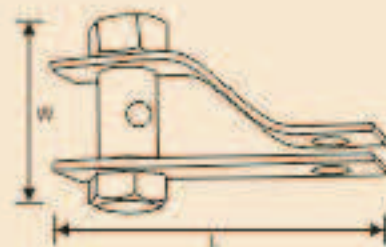

**1856 : MILD STEEL RATCHET STRAINER**



**TECHNICAL DATA**

ITEM CODE	LENGTH	WIDTH	THICKNESS	WT./PCS	PCS. IN INNER	PCS. IN OUTER
MMH1856000	80	82	2.0	0.430	10	50

FINISH AVAILABLE : BZP, EXB, HSG, DUROSIL

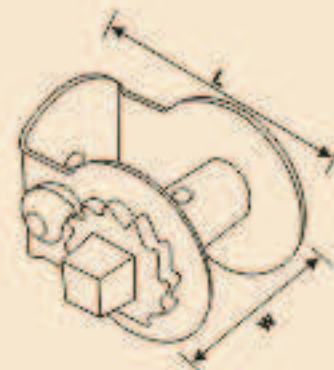

**1845 : MILD STEEL LARGE RADISSEURS**



**TECHNICAL DATA**

ITEM CODE	LENGTH	WIDTH	THICKNESS	WT./PCS	PCS. IN INNER	PCS. IN OUTER
NGR1845000	127	38	2.5	0.385	50	50
NGR1845000	127	38	3.0	0.430	50	50

FINISH AVAILABLE : BZP, EXB, HSG, DUROSIL



Available in High corrosion resistant finishes



**1850 : MILD STEEL SMALL RADISSEURS**



**TECHNICAL DATA**

ITEM CODE	LENGTH	WIDTH	THICKNESS	WT./PCS	PCS. IN INNER	PCS. IN OUTER
MGR1850000	102	32	2.0	0.214	50	50

FINISH AVAILABLE : BZP, EXB, HSG, DUROSIL



**1910 : MILD STEEL ANGLE CLEATS**



**TECHNICAL DATA**

ITEM CODE	LENGTH	WIDTH	THICKNESS	BOLT SIZE	WT./PCS	PCS. IN INNER	PCS. IN OUTER
MGR1910030	40x40	38	5.0	20x11	0.091	20	200
MGR1910040	40x65	38	5.0	20x11	0.119	10	150
MGR1910050	50x50	50	5.0	30x11	0.152	10	100
MGR1910075	40x75	40	6.0	30x11	0.191	10	80
MGR1910120	50x75	50	6.0	30x11	0.264	10	60

FINISH AVAILABLE : BZP, EXB, HSG, DUROSIL



**1950 : MILD STEEL STRETCHER BARS**



**TECHNICAL DATA**

ITEM CODE	LENGTH	WIDTH	THICKNESS	SLOT SIZE	SLOT POSITION	WT./PCS	PCS. IN OUTER
MGR1950450	460	25	5.0	20x11	200	0.422	10
MGR1950800	820	20	5.0	20x11	430	0.690	10
MGR1950850	950	25	5.0	20x11	430	0.876	10
MGR1951050	1410	20	5.0	20x11	690	1.410	10

FINISH AVAILABLE : BZP, EXB, HSG, DUROSIL



Available in High corrosion resistant finishes



1502 : MILD STEEL WEATHER BAR



TECHNICAL DATA

ITEM CODE	LENGTH	WIDTH	THICKNESS	WT./PCS	PCS. IN OUTER
MGP250240	1000	25	6.0	0.990	10
MGP250280	2000	25	6.0	1.177	10
MGP300240	1000	30	6.0	1.325	10
MGP300280	2000	30	6.0	1.177	10

AVAILABLE LENGTH : UP TO 2 Mtr  
FINISH AVAILABLE : EXB, HSG, DUROSIL



1418 : MILD STEEL BARBED WIRE SPACERS



TECHNICAL DATA

ITEM CODE	LENGTH	WIDTH	THICKNESS	BOLT SIZE	WT./PCS	PCS. IN INNER	PCS. IN OUTER
MMH1418460	460	25	5.0	30x11	0.400	10	40

FINISH AVAILABLE : BZR, EXB, HSG, DUROSIL



19912 : MILD STEEL GRAVEL CLEAT



TECHNICAL DATA

ITEM CODE	LENGTH	WIDTH	THICKNESS	PIN DIA	SHOET SIZE	WT./PCS	PCS. IN INNER	PCS. IN OUTER
MGR1951150	150	50	5.0	10	24x11	0.312	10	50
MGR1951300	300	50	5.0	10	28x12	0.615	5	30

FINISH AVAILABLE : EXB, HSG, DUROSIL

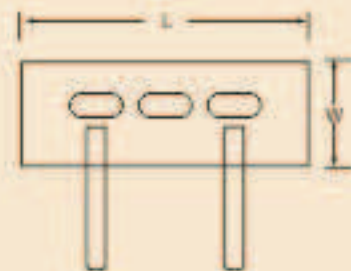

Available in High corrosion resistant finishes



**5002 : MILD STEEL BARBED WIRE BRACKET - FRONT FACE FIXING**



**TECHNICAL DATA**

ITEM CODE	LENGTH	WIDTH	THICKNESS	SCREW COACH	WT/PCS	PCS. IN INNER	PCS. IN OUTER
MGR5002381	730	38	6.0	10X75	1.230	5	5

FINISH AVAILABLE : BZP, EX6, HSG, DURDIL



**5002 : MILD STEEL BARBED WIRE BRACKET - SIDE FACE FIXING**



**TECHNICAL DATA**

ITEM CODE	LENGTH	WIDTH	THICKNESS	WT/PCS	PCS. IN INNER	PCS. IN OUTER
MGR5003381	715	30	6.0	0.930	5	5

FINISH AVAILABLE : BZP, EX6, HSG, DURDIL



**1882 : MILD STEEL STAPLE ON PLATE**



**TECHNICAL DATA**

ITEM CODE	LENGTH	WIDTH	THICKNESS	SCREW NO.	WT/PCS	PCS. IN INNER	PCS. IN OUTER	PCS. IN PALLET
MGR1882050	50	50	5.0	10	0.104	10	200	4800

FINISH AVAILABLE : BZP, EX6, HSG, DURDIL



Available in High corrosion resistant finishes



**1884 : MILD STEEL RING ON PLATE**



**TECHNICAL DATA**

ITEM CODE	LENGTH	WIDTH	THICKNESS	SCREW NO.	WT./PCS	PCS. IN INNER	PCS. IN OUTER	PCS. IN PALLET
MGR1884050	50	50	5.0	10	0.190	10	100	4000

FINISH AVAILABLE : BZP, EXB, HSG, DURSIL

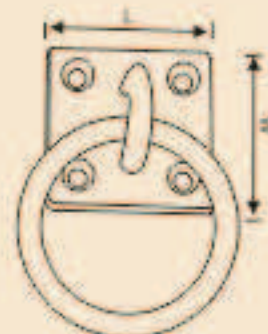

**1880 : MILD STEEL HOOK ON PLATE**



**TECHNICAL DATA**

ITEM CODE	LENGTH	WIDTH	THICKNESS	SCREW NO.	WT./PCS	PCS. IN INNER	PCS. IN OUTER	PCS. IN PALLET
MGR1880050	50	50	5.0	10	0.129	10	140	5040

FINISH AVAILABLE : BZP, EXB, HSG, DURSIL



**1886 : MILD STEEL MANGER RING ON EYE BOLT**



**TECHNICAL DATA**

ITEM CODE	LENGTH	RING DIA	RING WIRE DIA	RODE DIA	THREAD	WT./PCS	PCS. IN INNER	PCS. IN OUTER	PCS. IN PALLET
MGR1886125	135	68	8	8.8	M10	0.188	10	100	3600
MGR1886175	185	68	8	8.8	M10	0.211	10	80	3360
MGR1886200	235	68	8	8.8	M10	0.237	5	60	2160
MGR1886275	285	68	8	8.8	M10	0.259	5	50	1500

FINISH AVAILABLE : BZP, EXB, HSG, DURSIL



Available in High corrosion resistant finishes



**452 : MILD STEEL WELDED EYE BOLTS**



**TECHNICAL DATA**

ITEM CODE	LENGTH	THREAD	ROD DIA	WT./PCS	PCS. IN INNER	PCS. IN OUTER	PCS. IN PALLET
MGRD452150	150	M10	8.8	0.121	10	180	3840
MGRD452200	200	M10	8.8	0.147	10	140	5600
MGRD452250	250	M10	8.8	0.172	10	120	3940
MGRD452300	300	M10	8.8	0.198	10	100	3600

FINISH AVAILABLE - BZP, EXB, HSG, DUROSIL



**453 : MILD STEEL UNWELDED EYE BOLTS**



**TECHNICAL DATA**

ITEM CODE	LENGTH	THREAD	ROD DIA	WT./PCS	PCS. IN INNER	PCS. IN OUTER	PCS. IN PALLET
MGRD453150	150	M10	8.8	0.121	10	180	3840
MGRD453200	200	M10	8.8	0.147	10	140	5600
MGRD453250	250	M10	8.8	0.172	10	120	3840
MGRD453300	300	M10	8.8	0.198	10	100	3600

FINISH AVAILABLE - BZP, EXB, HSG, DUROSIL



**850 : MILD STEEL SINGLE POST HOOK**



**TECHNICAL DATA**

ITEM CODE	LENGTH	WIDTH	BOLT	WT./PCS	PCS. IN INNER	PCS. IN OUTER
MGRD850150	100	44	M10	0.164	10	100

FINISH AVAILABLE - BZP, EXB, HSG, DUROSIL



Available in High corrosion resistant finishes



851 : MILD STEEL DOUBLE POST HOOK



TECHNICAL DATA

ITEM CODE	LENGTH	WIDTH	BOLT	WT/PCS	PCS. IN INNER	PCS. IN OUTER
MGR0851150	180	44	M10	0.308	10	60

FINISH AVAILABLE - B2P, EXB, HSG, DUROSIL



454 : CAST IRON LOOP NUT



TECHNICAL DATA

ITEM CODE	LENGTH	DIA	WT/PCS	PCS. IN INNER	PCS. IN OUTER
MCR0454M10	42	37	0.096	20	200

FINISH AVAILABLE - B2P, EXB, HSG, DUROSIL, PEWTER



2404 : MILD STEEL BALUSTRADE BRACKET



TECHNICAL DATA

ITEM CODE	LENGTH	WIDTH	THICKNESS	SCREW NO.	WT/PCS	PCS. IN INNER	PCS. IN OUTER
MCP2404040	40x40	30	2.0	8	0.034	90	500

FINISH AVAILABLE - B2P, EXB, HSG, DUROSIL

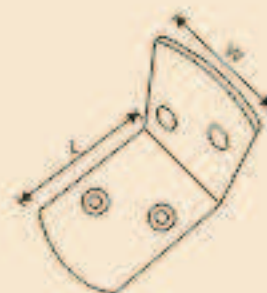

Available in High corrosion resistant finishes





9604 : MILD STEEL TRELLIS CLIP



TECHNICAL DATA

ITEM CODE	LENGTH	WIDTH	THICKNESS	SCREW NO.	WT./PCS	PCS. IN INNER	PCS. IN OUTER
MEFD604060	50	55	1.5	8	0.048	25	900

FINISH AVAILABLE - BZP, EXB, GALV

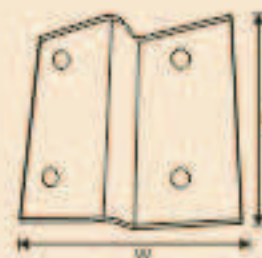

473-474-475 : MILD STEEL FENCING PANEL CLIPS



TECHNICAL DATA

ITEM CODE	LENGTH	WIDTH	HEIGHT	THICKNESS	WT./PCS	PCS. IN INNER	PCS. IN OUTER
MGRD473032	50	34	27	0.8	0.025	50	500
MGRD474044	50	45	27	0.8	0.029	50	500
MGRD475050	50	52	24	0.8	0.029	56	500

FINISH AVAILABLE - BZP, EXB, HSG, DUROSIL

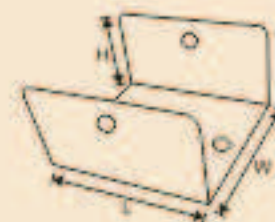

1164 : MILD STEEL GRAVEL BOARD BRACKET



TECHNICAL DATA

ITEM CODE	LENGTH	WIDTH	THICKNESS	SCREW NO.	WT./PCS	PCS. IN OUTER
MGR1164150	152	55	1.6	8	0.182	60

FINISH AVAILABLE - BZP, EXB, HSG, DUROSIL

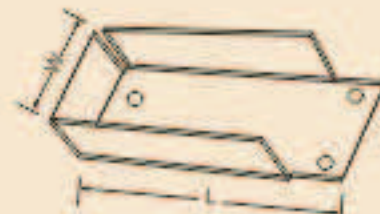

Available in High corrosion resistant finishes



**4025 : MILD STEEL BIRD MOUTH**



**TECHNICAL DATA**

ITEM CODE	LENGTH	WIDTH	THICKNESS	HOLE DIA	WT./PCS	PCS. IN OUTER
MMH4025100	250	80	0.75	4.2	0.241	60
MMH4025150	290	140	0.75	4.2	0.413	40

FINISH AVAILABLE - BZP, EXB, GALV



**75002 : MILD STEEL ARRIS RAIL REPAIR BRACKET**



**TECHNICAL DATA**

ITEM CODE	LENGTH	WIDTH	THICKNESS	HOLE DIA	WT./PCS	PCS. IN OUTER
MMH75002100	111	70	0.8	5	0.110	130
MMH75002200	226	60	0.8	5	0.168	80
MMH75002350	322	60	0.8	5	0.270	60

FINISH AVAILABLE - BZP, EXB, GALV



**8344 : MILD STEEL SLIP RAIL HOLDER**



**TECHNICAL DATA**

ITEM CODE	LENGTH	WIDTH	THICKNESS	SCREW NO.	WT./PCS	PCS. IN OUTER
MGFB344050	235	62	6.0	10	0.385	10

FINISH AVAILABLE - BZP, EXB, HSG, DUROSIL



Available in High corrosion resistant finishes



**8344 : MILD STEEL SLIP RAIL HOLDER**



**TECHNICAL DATA**

ITEM CODE	LENGTH	WIDTH	THICKNESS	SCREW NO.	WT./PCS	PCS. IN OUTER
NGF8344073	235	75	6.0	10	0.421	10

FINISH AVAILABLE - BZP, EXB, HSG, DUROSIL



**1897 : MILD STEEL SLIP RAIL BRACKET SET**



**TECHNICAL DATA**

ITEM CODE	LENGTH	WIDTH	THICKNESS	SCREW NO.	WT./PCS	PCS. IN INNER	PCS. IN OUTER
NGF1897200	191	92	3.0	10	0.360	5	50

FINISH AVAILABLE - BZP, EXB, HSG, DUROSIL

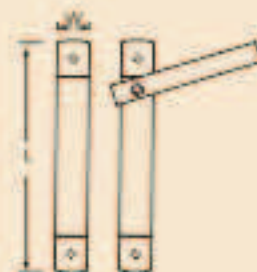

**8346 : MILD STEEL SLIP RAIL HALF ROUND HOLDER**



**TECHNICAL DATA**

ITEM CODE	LENGTH	WIDTH	THICKNESS	SCREW NO.	WT./PCS	PCS. IN OUTER
MGF834600X	250	25	6.0	10	0.394	10

FINISH AVAILABLE - BZP, EXB, HSG, DUROSIL



Available in High corrosion resistant finishes



**851A : MILD STEEL PANEL SECURITY BRACKET**



**TECHNICAL DATA**

ITEM CODE	LENGTH	WIDTH	THICKNESS	SCREW NO.	WT./PCS	PCS. IN OUTER
MGR851AXXX	237	40	1.5	8	0.133	80

FINISH AVAILABLE - BZP, EXB, HSG, DUROSIL



**9102 : MILD STEEL EXTENSION BASES**



**TECHNICAL DATA**

ITEM CODE	LENGTH	WIDTH	THICKNESS	SCREW NO.	SLOT SIZE	WT./PCS	PCS. IN INNER	PCS. IN OUTER
MMH9102225	225	25	5.0	8	10x8	0.166	10	100

FINISH AVAILABLE - BZP, EXB, HSG, DUROSIL



**4568 : MILD STEEL SCREW IN PANEL CLIP**



**TECHNICAL DATA**

ITEM CODE	LENGTH	WIDTH	THICKNESS	SCREW NO.	WT./PCS	PCS. IN INNER	PCS. IN OUTER
MGR4568003	34x38	30	2.0	14x48	0.045	50	400

FINISH AVAILABLE - BZP, EXB, HSG, DUROSIL



Available in High corrosion resistant finishes



412 : MILD STEEL VINE EYES TO SCREW



TECHNICAL DATA

ITEM CODE	LENGTH	WIRE DIA	WT./PCS	PCS. IN INNER	PCS. IN OUTER
MMH0412075	86	3.85	0.011	100	1000
MMH0412100	111	3.85	0.013	100	1000
MMH0412125	136	3.85	0.015	100	1000
MMH0412150	160	3.85	0.017	100	1000



FINISH AVAILABLE - ZP, ZPYP, EB

9032 : MILD STEEL VINE EYE TO DRIVE



TECHNICAL DATA

ITEM CODE	LENGTH	WIDTH	THICKNESS	WT./PCS	PCS. IN INNER	PCS. IN OUTER	PCS. IN PALLET
MMH9032075	75	12	2.5	0.011	50	500	30000
MMH9032100	100	12	2.5	0.014	50	500	30000
MMH9032125	125	16	2.5	0.022	50	500	22500
MMH9032150	150	16	2.5	0.027	50	500	22500

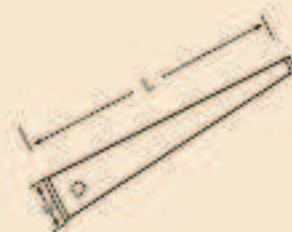

FINISH AVAILABLE - BZP, EXB

1800GC : MILD STEEL SELF LOCKING GATE CATCH ONLY



TECHNICAL DATA

ITEM CODE	LENGTH	WIDTH	THICKNESS	COACH SCREW	WT./PCS	PCS. IN INNER	PCS. IN OUTER	PCS. IN PALLET
MGR1801175	180	32	6.0	10x75	0.780	5	20	1000

FINISH AVAILABLE - BZP, EXB, HSD, DUROSIL

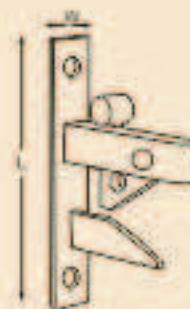

Available in High corrosion resistant finishes



**1800SS : MILD STEEL SELF LOCKING GATE CATCH STRIKER - STRAIGHT**



**TECHNICAL DATA**

ITEM CODE	LENGTH	WIDTH	ROD DIA	WT/ PCS	PCS. IN INNER	PCS. IN OUTER	PCS. IN PALLET
MGR1804191	185	40	12.5	0.240	10	80	2400

FINISH AVAILABLE - BZP, EXB, HSG, DUROSIL



**1800CS : MILD STEEL SELF LOCKING GATE CATCH STRIKER - CRANKED**



**TECHNICAL DATA**

ITEM CODE	LENGTH	WIDTH	ROD DIA	WT/ PCS	PCS. IN INNER	PCS. IN OUTER	PCS. IN PALLET
MGR1802191	185	40	12.5	0.230	10	80	2400

FINISH AVAILABLE - BZP, EXB, HSG, DUROSIL



**1800DLS : MILD STEEL STRIKER DOUBLE LEG**



**TECHNICAL DATA**

ITEM CODE	LENGTH	WIDTH	ROD DIA	THREAD	WT/ PCS	PCS. IN INNER	PCS. IN OUTER	PCS. IN PALLET
MGR1848170	170	80	11.8	M12	0.360	5	20	600

FINISH AVAILABLE - BZP, EXB, HSG, DUROSIL



Available in High corrosion resistant finishes



**1800 : MILD STEEL SELF LOCKING GATE CATCH WITH STRIKER**



**TECHNICAL DATA**

DESCRIPTION	PCS. IN OUTER
ITEM CODE	NGR1800175
SELF LOCKING GATE CATCH (1800GC)	1
CRANKED STRICKER ONLY (1800CS)	1
COACH SCREW (M10X75)	2
TOTAL WT SET	1.080

FINISH AVAILABLE - EXB, BZP, HSG, DURDIL

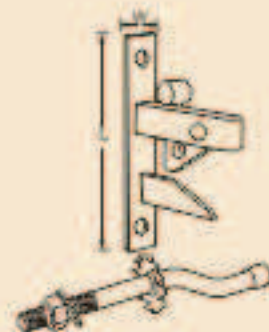

**1805 : MILD STEEL HUNTING TYPE GATE CATCH**



**TECHNICAL DATA**

ITEM CODE	LENGTH	WIDTH	ROD DIA	THICKNESS	COACH SCREW	WT/ PCS	PCS. IN INNER	PCS. IN OUTER	PCS. IN PALLET
NGR1805100	180	32	16.0	6.0	10x75	1.360	2	20	400

FINISH AVAILABLE - EXB, BZP, HSG, DURDIL



**1000 : MILD STEEL SAFETY GATE HOOKS AND EYES**



**TECHNICAL DATA**

ITEM CODE	LENGTH	WIDTH	THICKNESS	WT/ PCS	PCS. IN INNER	PCS. IN OUTER	PCS. IN PALLET
NGR1000150	153	60	6.0	0.300	5	60	2880

FINISH AVAILABLE : BZP, EXB, HSG, DURDIL



Available in High corrosion resistant finishes



1810 : MILD STEEL THROWOVER GATE LOOPS



TECHNICAL DATA

ITEM CODE	LENGTH	WIDTH	THICKNESS	CARRIAGE BOLT	WT/ PCS	PCS. IN INNER	PCS. IN OUTER
MGR1810175	170	80	5.0	M10	0.482	5	40

FINISH AVAILABLE - BZP, EXB, HSG, DUROSIL



1810 : MILD STEEL THROWOVER GATE LOOPS



TECHNICAL DATA

ITEM CODE	LENGTH	WIDTH	THICKNESS	CARRIAGE BOLT	WT/ PCS	PCS. IN INNER	PCS. IN OUTER	PCS. IN PALLET
MGR1810350	360	80	5.0	M10	0.970	2	10	340
MGR1810450	410	80	5.0	M10	1.200	2	10	240
MGR1810500	490	80	5.0	M10	1.324	2	10	240

FINISH AVAILABLE - BZP, EXB, HSG, DUROSIL



1816 : MILD STEEL THROWOVER GATE LOOP WITH LIFT HANDLE



TECHNICAL DATA

ITEM CODE	LENGTH	WIDTH	THICKNESS	CARRIAGE BOLT	WT/ PCS	PCS. IN OUTER	PCS. IN PALLET
MGR1816350	458	78	6.0	M10	2.550	5	150

FINISH AVAILABLE - BZP, EXB, HSG, DUROSIL

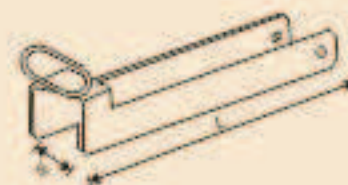

Available in High corrosion resistant finishes





**1816 LHS : MILD STEEL THROWOVER GATE LOOP WITH LOCKING HASP & STAPLE**



**TECHNICAL DATA**

ITEM CODE	LENGTH	WIDTH	THICKNESS	CARRIAGE BOLT	WT/ PCS	PCS. IN OUTER
MGR0818450	450	90	6.0	M10&12	2.710	2

FINISH AVAILABLE - BZP EXB, HSG, DUROSIL



**9002 : MILD STEEL GRAVITY CATCH FOR WOODEN POST**



**TECHNICAL DATA**

ITEM CODE	LENGTH	WIDTH	THICKNESS	WT/ PCS	PCS. IN INNER	PCS. IN OUTER
MGR030275	270	70	6.0	0.689	3	25

FINISH AVAILABLE - BZP EXB, HSG, DUROSIL



**1870 : CAST GRAVITY CATCH**



**TECHNICAL DATA**

ITEM CODE	LENGTH	WIDTH	THICKNESS	CARRIAGE BOLT	WT/ PCS	PCS. IN INNER	PCS. IN OUTER	PCS. IN PALLET
MGR1870240	240	320	20	M12	3.250	2	4	280

FINISH AVAILABLE - EXB, HSG, DUROSIL

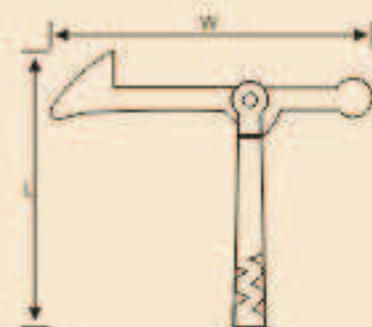

Available in High corrosion resistant finishes



406 : MILD STEEL DEVON GATE DROPS



TECHNICAL DATA

ITEM CODE	LENGTH	WIDTH	THICKNESS	WT/ PCS	PCS. IN INNER	PCS. IN OUTER
MGRD406150	150	80	7.8	0.112	10	100

FINISH AVAILABLE - BZP EXB, HSG, DUROSIL



G0122 : CAST IRON ROUND GATE DROPS



TECHNICAL DATA

ITEM CODE	LENGTH	WIDTH	RAD DIA	WT/ PCS	PCS. IN INNER	PCS. IN OUTER
MGRD0122150	140	51	8.0	0.085	10	100

FINISH AVAILABLE - BZP EXB, HSG, DUROSIL

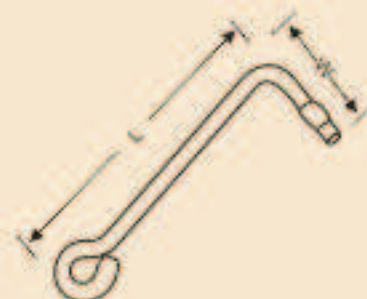

1830 : MILD STEEL KICK OVER GATE LATCH



TECHNICAL DATA

ITEM CODE	LENGTH	WIDTH	THICKNESS	SCREW NO.	WT/ PCS	PCS. IN INNER	PCS. IN OUTER
MGR1830225	238	40	6.0	12	1.415	5	20

FINISH AVAILABLE - BZP EXB, HSG, DUROSIL

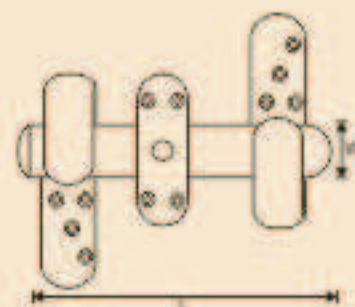

Available in High corrosion resistant finishes



**1830A : MILD STEEL KICK OVER STABLE LATCH**

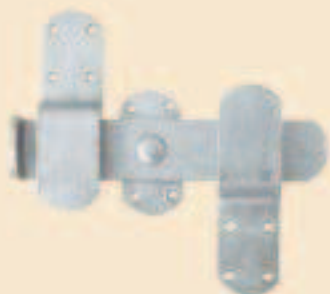

**TECHNICAL DATA**

ITEM CODE	LENGTH	WIDTH	THICKNESS	SCREW NO.	WT/ PCS	PCS. IN INNER	PCS. IN OUTER
MGR1831220	250	50	6.0	10	1.810	2	10

FINISH AVAILABLE - B2P, EXB, HSG, DURSIL

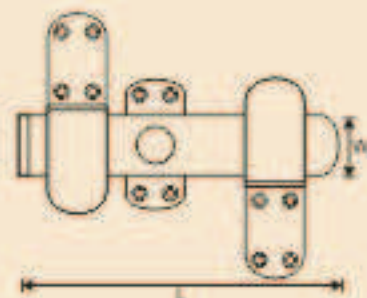

**6252 : MILD STEEL DOOR STAPLES**



**TECHNICAL DATA**

ITEM CODE	LENGTH	WIDTH	DIA	WT/ PCS	PCS. IN INNER	PCS. IN OUTER	PCS. IN PALLET
MGR6252060	65	37	8	0.030	30	300	18000
MGR6252075	75	41	8	0.063	30	250	9000
MGR6252100	110	41	8	0.084	20	200	9000

FINISH AVAILABLE - B2P, EXB, HSG, DURSIL



**1820EET : MILD STEEL SQUARE SECTION GATE STAPLE TO DRIVE**



**TECHNICAL DATA**

ITEM CODE	LENGTH	WIDTH	SQUARE	WT/ PCS	PCS. IN INNER	PCS. IN OUTER
MGR4127100	125	104	10	0.215	20	80

FINISH AVAILABLE : B2P, EXB, HSG, DURSIL



Available in High corrosion resistant finishes



**1820 E : MILD STEEL STAPLE TO DRIVE**



**TECHNICAL DATA**

ITEM CODE	LENGTH	WIDTH	DIA	WT/ PCS	PCS. IN INNER	PCS. IN OUTER
MGR1823100	125	104	10	0.215	20	60

FINISH AVAILABLE : B2P EXB, HSG, DUROSIL



**1806 : MILD STEEL HOOK TO BOLT**



**TECHNICAL DATA**

ITEM CODE	LENGTH	WIDTH	PIN DIA	THREAD	WT/ PCS	PCS. IN INNER	PCS. IN OUTER	PCS. IN PALLET
MGR1806200	200	42	19	M20	0.800	5	20	960
MGR1806300	300	42	19	M20	1.103	5	20	640

FINISH AVAILABLE : B2P EXB, HSG, DUROSIL



**1896 : MILD STEEL GATE HANGER TO BOLT**



**TECHNICAL DATA**

ITEM CODE	LENGTH	WIDTH	THREAD	PIN DIA	WT/ PCS	PCS. IN OUTER
MGR1896200	200	75	M20	10	0.850	10
MGR1896250	250	75	M20	19	1.000	10
MGR1896350	350	75	M20	19	1.230	10
MGR1896400	410	75	M20	19	1.300	10
MGR1896450	490	75	M20	19	1.390	10

FINISH AVAILABLE - B2P EXB, HSG, DUROSIL

Available in High corrosion resistant finishes





**1875 : MILD STEEL HOOK FOR BRICK WORK**



**TECHNICAL DATA**

ITEM CODE	LENGTH	WIDTH	THICKNESS	PIN DIA	WT/ PCS	PCS. IN INNER	PCS. IN OUTER
MGR1875150	150	20	6.0	12.7	0.367	10	50
MGR1875275	275	20	6.0	12.7	0.631	10	30
MGR1875150	150	25	6.0	19.0	0.580	5	20
MGR1875275	275	25	6.0	19.0	0.918	5	15

FINISH AVAILABLE - BZP, EXB, HSG, DUROSIL

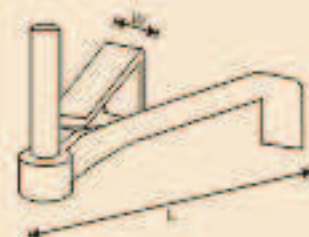

**1803 : MILD STEEL HOOK TO DRIVE**



**TECHNICAL DATA**

ITEM CODE	LENGTH	WIDTH	PIN DIA	WT/ PCS	PCS. IN INNER	PCS. IN OUTER	PCS. IN PALLET
MGR1803200	216	41	20	0.790	5	30	1000
MGR1803200	216	41	22	0.789	5	20	900

FINISH AVAILABLE - BZP, EXB, HSG, DUROSIL

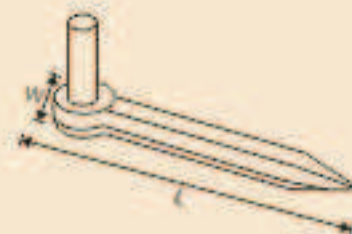

**1814A : MILD STEEL HOOK ON SQUARE PLATE**



**TECHNICAL DATA**

ITEM CODE	LENGTH	WIDTH	THICKNESS	PIN DIA	WT/ PCS	PCS. IN INNER	PCS. IN OUTER	PCS. IN PALLET
MGR1804100	100	100	5.0	19	0.775	5	30	720

FINISH AVAILABLE - BZP, EXB, HSG, DUROSIL

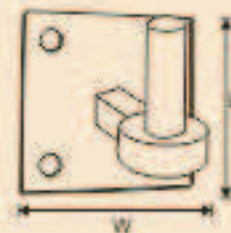

Available in High corrosion resistant finishes



**1814AH : MILD STEEL ADJUSTABLE HOOK ON SQUARE PLATE**



**TECHNICAL DATA**

ITEM CODE	LENGTH	WIDTH	THICKNESS	PIN DIA	THREAD	WT/ PCS	PCS. IN INNER	PCS. IN OUTER	PCS. IN PALLET
MGR1815101	100	100	5.0	19.0	M20	0.900	5	20	720

FINISH AVAILABLE - BZP EXB, HSG, DURASIL

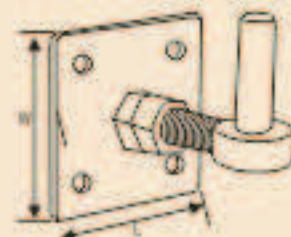

**435 : MILD STEEL HOOK ON NARROW PLATE**



**TECHNICAL DATA**

ITEM CODE	LENGTH	WIDTH	THICKNESS	PIN DIA	COACH SCREW	WT/ PCS	PCS. IN INNER	PCS. IN OUTER
MGR0435200	200	50	8.0	24	M12	1.130	5	10

FINISH AVAILABLE - EXB, BZP HSG



**1865H : MILD STEEL GATE HOOK TO WELD (FLAT)**



**TECHNICAL DATA**

ITEM CODE	LENGTH	WIDTH	THICKNESS	PIN DIA	WT/ PCS	PCS. IN INNER	PCS. IN OUTER
MGR1867012	40	25	10	12	0.090	20	200
MGR1867016	63	46	16	16	0.400	10	40
MGR1867019	63	46	16	18	0.440	5	40
MGR1867022	63	46	16	22	0.470	5	40
MGR1867024	63	46	16	25	0.503	5	30

FINISH AVAILABLE - SC, EXB, HSG, DURASIL

Available in High corrosion resistant finishes





**1866H : MILD STEEL GATE HOOK TO WELD (RADIUS)**



**TECHNICAL DATA**

ITEM CODE	LENGTH	WIDTH	THICKNESS	PIN DIA	WT/ PCS	PCS. IN INNER	PCS. IN OUTER
MGF1866H13	40	25	10	12	0.083	20	200
MGF1866H16	63	46	16	16	0.400	10	40
MGF1866H19	63	46	16	19	0.440	5	40
MGF1866H22	63	46	16	22	0.479	5	40
MGF1866H24	63	46	16	25	0.503	5	30

FINISH AVAILABLE : SC, EXB, HSG, DUROSIL



**1865E : MILD STEEL GATE EYE TO WELD (FLAT)**



**TECHNICAL DATA**

ITEM CODE	LENGTH	WIDTH	THICKNESS	PIN DIA	WT/ PCS	PCS. IN INNER	PCS. IN OUTER
MGF1865E13	40	25	10	13	0.060	20	240
MGF1865E16	63	46	16	17	0.340	10	60
MGF1865E19	63	46	16	20	0.300	10	60
MGF1865E22	63	46	16	23	0.246	10	60
MGF1865E25	63	46	16	26	0.200	10	60

FINISH AVAILABLE : SC, EXB, HSG, DUROSIL



**1866E : MILD STEEL GATE EYE TO WELD (RADIUS)**



**TECHNICAL DATA**

ITEM CODE	LENGTH	WIDTH	THICKNESS	PIN DIA	WT/ PCS	PCS. IN INNER	PCS. IN OUTER
MGF1866E13	40	25	10	13	0.060	20	240
MGF1866E16	63	46	16	17	0.340	10	60
MGF1866E19	63	46	16	20	0.300	10	60
MGF1866E22	63	46	16	23	0.246	10	60
MGF1866E25	63	46	16	26	0.200	10	25

FINISH AVAILABLE : SC, EXB, HSG, DUROSIL

Available in High corrosion resistant finishes





**1809 : MILD STEEL FIELD GATE ADJUSTABLE EYE C/W 2 NUTS**

**TECHNICAL DATA**

ITEM CODE	LENGTH	WIDTH	THICKNESS	HOLE DIA	THREAD	WT/ PCS	PCS. IN INNER	PCS. IN OUTER	PCS. IN PALLET
MGR1709100	100	30	12	13	M12	0.163	5	100	2400
MGR1709150	150	30	12	13	M12	0.200	5	80	1920
MGR1709200	200	30	12	13	M12	0.237	5	80	1800
MGR1709250	250	30	12	13	M12	0.274	5	60	1500
MGR1710100	100	36	15	17	M16	0.291	5	80	1920
MGR1710150	150	36	15	17	M16	0.329	5	40	1600
MGR1710200	200	36	15	17	M16	0.377	5	40	1280
MGR1710250	250	36	15	17	M16	0.425	5	40	1280
MGR1711100	100	42	17.5	20	M20	0.437	5	40	1500
MGR1711150	150	42	17.5	20	M20	0.513	5	30	1500
MGR1711200	200	42	17.5	20	M20	0.589	5	30	1320
MGR1711250	250	42	17.5	20	M20	0.665	5	20	960
MGR1711300	300	42	17.5	20	M20	0.741	5	20	720
MGR1712100	100	42	17.5	23	M22	0.426	5	30	1440
MGR1712150	150	42	17.5	23	M22	0.502	5	20	960
MGR1712200	200	42	17.5	23	M22	0.578	5	20	960
MGR1712250	250	42	17.5	23	M22	0.654	5	20	960
MGR1713300	300	42	17.5	23	M22	0.730	5	20	720
MGR1713100	100	56	24	26	M25	0.850	5	5	720
MGR1713150	150	56	24	26	M25	1.006	5	5	840
MGR1713200	200	56	24	26	M25	1.199	5	5	520
MGR1713250	250	56	24	26	M25	1.388	5	5	520
MGR1713300	300	56	24	26	M25	1.578	5	5	520



FINISH AVAILABLE - BZF, EXB, HSG, DUROSIL

**1809F : MILD STEEL EYE BOLT WITH 'U' CLIPS**

**TECHNICAL DATA**

ITEM CODE	LENGTH	WIDTH	THICKNESS	THREAD	WT/ PCS	PCS. IN INNER	PCS. IN OUTER
MGR1723250	254	42	6.0	M20	1.30	5	5



FINISH AVAILABLE - BZF, EXB, HSG, DUROSIL

Available in High corrosion resistant finishes





**1812AS : MILD STEEL FIELD GATE BOTTOM HINGE**



**TECHNICAL DATA**

ITEM CODE	LENGTH	WIDTH	THICKNESS	WT/ PCS	PCS. IN INNER	PCS. IN OUTER
MGF1832125	180	76	6.0	0.875	5	20

FINISH AVAILABLE - BZF EXB, HSG, DUROSIL  
ALSO AVAILABLE IN 5MM THICKNESS



**1812AAS : MILD STEEL SLOTTED BAND FOR ADJUSTABLE FIELD GATE HINGE**



**TECHNICAL DATA**

ITEM CODE	LENGTH	WIDTH	THICKNESS	WT/ PCS	PCS. IN INNER	PCS. IN OUTER
MGF1821125	184	77	6.0	0.867	5	20

FINISH AVAILABLE - BZF EXB, HSG, DUROSIL  
ALSO AVAILABLE IN 5MM THICKNESS



**1812 AL : MILD STEEL FIELD GATE HINGE LONG BAND**



**TECHNICAL DATA**

ITEM CODE	LENGTH	WIDTH	THICKNESS	SCREW NO.	WT/ PCS	PCS. IN INNER	PCS. IN OUTER
MGF1825300	300	78	6.0	M10	1.488	2	2
MGF1825450	450	78	6.0	M10	2.274	2	2
MGF1825600	600	78	6.0	M10	3.060	2	2

FINISH AVAILABLE - BZF EXB, HSG, DUROSIL  
ALSO AVAILABLE IN 5MM THICKNESS

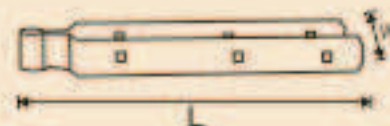

Available in High corrosion resistant finishes



**1820A : MILD STEEL SPRING LATCH**



**TECHNICAL DATA**

ITEM CODE	LENGTH	WIDTH	THICKNESS	CARRIAGE BOLT	WT/ PCS	PCS. IN INNER	PCS. IN OUTER	PCS. IN PALLET
MGR11820800	590	45	4.0	NO	0.903	5	15	750

FINISH AVAILABLE - BZP, EXB, HSG, DUROBIL.



**1820B : MILD STEEL SPRING KEEP**



**TECHNICAL DATA**

ITEM CODE	LENGTH	WIDTH	THICKNESS	SCREW NO.	WT/ PCS	PCS. IN INNER	PCS. IN OUTER	PCS. IN PALLET
MGR11827225	238	76	5.0	12	0.493	5	30	1500

FINISH AVAILABLE - BZP, EXB, HSG, DUROBIL.



**1820C : MILD STEEL SPRING CATCH**



**TECHNICAL DATA**

ITEM CODE	LENGTH	WIDTH	THICKNESS	WT/ PCS	PCS. IN INNER	PCS. IN OUTER	PCS. IN PALLET
MGR11828200	212	60	12.0	0.455	5	30	1500

FINISH AVAILABLE - BZP, EXB, HSG, DUROBIL.



Available in High corrosion resistant finishes



**1860 : MILD STEEL CENTRAL CLOSING GATE CATCH**



**TECHNICAL DATA**

ITEM CODE	LENGTH	WIDTH	THICKNESS	SCREW	WT/ PCS	PCS. IN INNER	PCS. IN OUTER
MGR1860175	151	40	5.0	10	0.350	5	50

FINISH AVAILABLE - BZP, EXB, HSG, DUROSIL



**1820D : MILD STEEL SINGLE LEG DRIVER CATCH**



**TECHNICAL DATA**

ITEM CODE	LENGTH	WIDTH	THICKNESS	WT/ PCS	PCS. IN INNER	PCS. IN OUTER
MGR1824200	200	30	10	0.345	5	30

FINISH AVAILABLE - BZP, EXB, HSG, DUROSIL



**1890B : MILD STEEL FIELD GATE HINGE RISING S. BAND**



**TECHNICAL DATA**

ITEM CODE	LENGTH	WIDTH	THICKNESS	SCREW NO.	WT/ PCS	PCS. IN INNER	PCS. IN OUTER
MGR1895150	152	152	8.0	14	1.920	2	4

FINISH AVAILABLE - BZP, EXB, HSG, DUROSIL

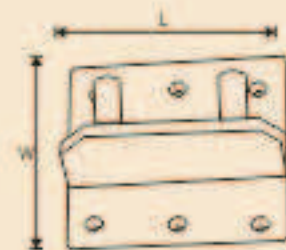

Available in High corrosion resistant finishes



1890C : MILD STEEL FIELD GATE HINGE RISING S. BAND



TECHNICAL DATA

ITEM CODE	LENGTH	WIDTH	THICKNESS	THREAD	WT/ PCS	PCS. IN INNER	PCS. IN OUTER
MGR1896200	200	147	10/22	M12	1.522	2	2

FINISH AVAILABLE - BZP, EXB, HSG, DUROSIL

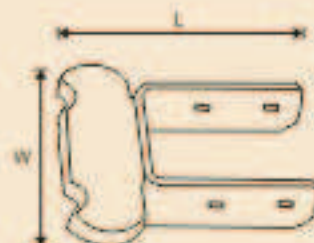

1890A : MILD STEEL FIELD GATE HINGE RISING S. BAND

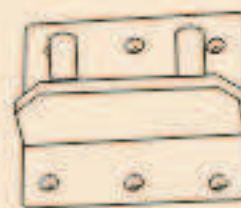

FINISH AVAILABLE - BZP, EXB, HSG, DUROSIL

2430 : MILD STEEL POST RAMMER



TECHNICAL DATA

ITEM CODE	LENGTH	WIDTH	BID PIPE DIA	WT/ PCS	PCS. IN INNER	PCS. IN OUTER
MGR2430150	830	320	150	19.300	1	1

FINISH AVAILABLE - EXB



Available in High corrosion resistant finishes



**1812 : MILD STEEL STANDARD FIELD GATE SET**

**TECHNICAL DATA**

DESCRIPTION	300MM	450MM	600MM
ITEM CODE	MGF1812300	MGF1812450	MGF1812600
TOP BAND (1812AL)	1	1	1
BOTTOM BAND (1812AS)	1	1	1
HOOK TO BOLT (1806)	1	1	1
HOOK TO DRIVE (1803)	1	1	1
CARRIAGE BOLT M10x110	3	4	4
SCREW 12x1.25"	2	2	2
TOTAL WT. SET	4.514	5.383	6.109



FINISH AVAILABLE - B2P, EXB, HSG, DUROSIL  
ALSO AVAILABLE LIGHTER VERSION 5 MM THICKNESS

**1813 : MILD STEEL ADJUSTABLE FIELD GATE HINGE SET**

**TECHNICAL DATA**

DESCRIPTION	300MM	450MM	600MM
ITEM CODE	MGF1813300	MGF1813450	MGF1813600
TOP BAND (1812AL)	1	1	1
HOOK TO BOLT (1806)	1	1	1
HOOK TO DRIVE (1803)	1	1	1
ADJUSTABLE EYE WITH U CLIP (1805F)	1	1	1
CARRIAGE BOLT (M10X110)	2	3	3
TOTAL WT. SET	4.785	5.655	6.380



FINISH AVAILABLE - B2P, EXB, HSG, DUROSIL  
ALSO AVAILABLE LIGHTER VERSION 5 MM THICKNESS

**1814 : MILD STEEL ADJUSTABLE HINGE SET WITH HOOK ON PLATE**

**TECHNICAL DATA**

DESCRIPTION	300MM	450MM	600MM
ITEM CODE	MGF1814300	MGF1814450	MGF1814600
TOP BAND (1812AL)	1	1	1
EYE BOLT WITH U CLIP (1805F)	1	1	1
HOOK ON SQUARE PLATE 4"X4" (1814A)	2	2	2
CARRIAGE BOLTS M10X110	2	3	3
COACH SCREW M10X75	8	8	8
TOTAL WT. SET	4.742	5.612	6.338



FINISH AVAILABLE - B2P, EXB, HSG, DUROSIL  
ALSO AVAILABLE LIGHTER VERSION 5 MM THICKNESS

Available in High corrosion resistant finishes



**1817 : MILD STEEL STANDARD HINGE SET HOOKS ON PLATE**



**TECHNICAL DATA**

DESCRIPTION	300MM	450MM	600MM
ITEM CODE	MGF1817300	MGF1817450	MGF1817800
TOP BAND (1812AL)	1	1	1
BOTTOM BAND (1812AS)	1	1	1
HOOK ON PLATE 4X4 (1814A)	2	2	2
CARRIAGE BOLTS WITH NUT	3	4	4
COACH SCREW M10X75	8	8	8
SCREW 12x1.25"	2	2	2
TOTAL Wt. SET:	4.472	5.341	6.050

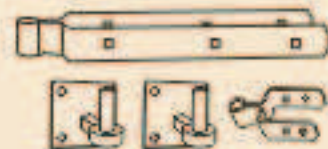

FINISH AVAILABLE - B2P, EX8, HSG, DUROSIL  
ALSO AVAILABLE LIGHTER VERSION 5 MM THICKNESS

**1820 : MILD STEEL SPRING LATCH HINGE SET**



**TECHNICAL DATA**

DESCRIPTION	SET
ITEM CODE	MGF1820000
SPRING LATCH	1
SPRING KEEP	1
SPRING CATCH	1
CARRIAGE BOLTS (MBx110)	1
SCREW 12x1.25"	5
TOTAL Wt. SET:	1.850



FINISH AVAILABLE - B2P, EX8, HSG, DUROSIL

**2802 : MILD STEEL DOUBLE GATE FASTENER SET**

**TECHNICAL DATA**

DESCRIPTION	SET
ITEM CODE	MGF2802450
THROWOVER 14" (1810)	1
DOOR BOLT 18" (00X)	1
CARRIAGE BOLTS (MBx110)	1
SCREW 10x1.25"	14
TOTAL Wt. SET:	2.395



FINISH AVAILABLE - B2P, EX8, HSG, DUROSIL

Available in High corrosion resistant finishes



**1311 : MILD STEEL GATE HANGER HORIZONTAL TOP**



**TECHNICAL DATA**

ITEM CODE	LENGTH	WIDTH	THICKNESS	PIPE DIA	WT/ PCS	PCS. IN INNER	PCS. IN OUTER
MDR1311150	150	50	8	42	0.642	4	20

FINISH AVAILABLE - BZP EXB, HSG, DUROSIL

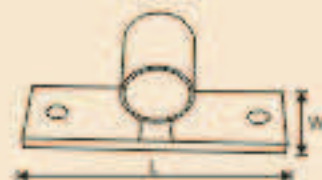

**1312 : MILD STEEL GATE HANGER HORIZONTAL BOTTOM**



**TECHNICAL DATA**

ITEM CODE	LENGTH	WIDTH	THICKNESS	PIPE DIA	WT/ PCS	PCS. IN INNER	PCS. IN OUTER
MDR1312150	150	50	8	42	0.670	4	20

FINISH AVAILABLE - BZP EXB, HSG, DUROSIL



**1314 : MILD STEEL GATE HANGER VERTICAL TOP**



**TECHNICAL DATA**

ITEM CODE	LENGTH	WIDTH	THICKNESS	PIPE DIA	WT/ PCS	PCS. IN INNER	PCS. IN OUTER
MDR1314150	150	50	8	42	0.631	4	20

FINISH AVAILABLE - BZP EXD, HSG, DUROSIL



Available in High corrosion resistant finishes



**1315 : MILD STEEL GATE HANGER VERTICAL BOTTOM**



**TECHNICAL DATA**

ITEM CODE	LENGTH	WIDTH	THICKNESS	PIPE DIA	WT/ PCS	PCS. IN INNER	PCS. IN OUTER
MGR1315150	150	50	6	42	0.720	4	20

FINISH AVAILABLE - BZP, EXB, HSG, DUROSIL

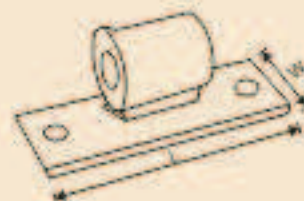

**1321 : MILD STEEL GATE HANGER RSJ BOTTOM**



**TECHNICAL DATA**

ITEM CODE	LENGTH	WIDTH	THICKNESS	PIPE DIA	WT/ PCS	PCS. IN INNER	PCS. IN OUTER
MGR1321126	126	75	7	42	0.946	4	20

FINISH AVAILABLE - BZP, EXB, HSG, DUROSIL



**1322 : MILD STEEL GATE HANGER RSJ TOP**



**TECHNICAL DATA**

ITEM CODE	LENGTH	WIDTH	THICKNESS	PIPE DIA	WT/ PCS	PCS. IN INNER	PCS. IN OUTER
MGR1322136	126	75	7	42	0.904	4	20

FINISH AVAILABLE - BZP, EXB, HSG, DUROSIL

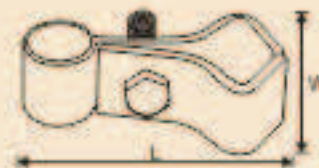

Available in High corrosion resistant finishes





**1331 : MILD STEEL GATE HANGER THREADED BAR BOTTOM**



**TECHNICAL DATA**

ITEM CODE	LENGTH	ROD DIA	OUTER DIA	INNER DIA	WT/ PCS	PCS. IN INNER	PCS. IN OUTER
NGF1331300	355	12X5/16"	42	36	0.896	4	20

FINISH AVAILABLE - BZP, EXB, HSG, DUROSIL

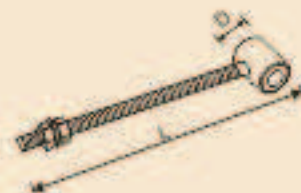

**1333 : MILD STEEL GATE HANGER THREADED BAR TOP**



**TECHNICAL DATA**

ITEM CODE	LENGTH	ROD DIA	OUTER DIA	INNER DIA	WT/ PCS	PCS. IN INNER	PCS. IN OUTER
NGF1333250	310	10X5/8"	42	36	0.534	4	20

FINISH AVAILABLE - BZP, EXB, HSG, DUROSIL



**1341 : MILD STEEL GATE HANGER THREADED BAR TOP**



**TECHNICAL DATA**

ITEM CODE	LENGTH	ROD DIA	OUTER DIA	INNER DIA	WT/ PCS	PCS. IN INNER	PCS. IN OUTER
NGF1341300	355	12X5/16"	42	36	0.870	4	20

FINISH AVAILABLE - BZP, EXB, HSG, DUROSIL



Available in High corrosion resistant finishes



**1343 : MILD STEEL GATE HANGER THREADED BAR BOTTOM**



**TECHNICAL DATA**

ITEM CODE	LENGTH	ROD DIA	OUTER DIA	INNER DIA	WT/ PCS	PCS. IN INNER	PCS. IN OUTER
MGR1343250	310	10X5/8"	42	36	0.554	4	20

FINISH AVAILABLE - BZP, EXB, HSG, DUROSIL



**1060 : MILD STEEL CELLAR HINGES**



**TECHNICAL DATA**

ITEM CODE	SIZE	LENGTH	WIDTH	THICKNESS	SCREW NO.	BOLT NO.	WT/ PCS	PCS IN INNER	PCS IN OUTER
MGR1060450	18"	460	125	4.0	10	12X60	1.170	2	4

FINISH AVAILABLE : BZP, EXB, HSG, DUROSIL



**HALF ROUND GATE HANGER**



**TECHNICAL DATA**

DPG CODE	ITEM CODE	NAME	HEIGHT	WIDTH	THICKNESS	PIPE IN. DIA.	PIPE OUT. DIA.	WT/ PCS	PCS IN INNER	PCS IN OUTER
1354	MGR1354000	BOTTOM	146	50	3.7	36	42	0.580	4	20
1353	MGR1353000	TOP	146	50	3.7	36	42	0.580	4	20

FINISH AVAILABLE : BZP, EXB, HSG, DUROSIL



Available in High corrosion resistant finishes



**G2276 : CAST IRON GATE HANGER SPUD**



**TECHNICAL DATA**

ITEM CODE	LENGTH	WIDTH	HOLE DIA	WT/ PCS	PCS. IN INNER	PCS. IN OUTER
COEM2276040	62	62	42MM	0.533	4	20

FINISH AVAILABLE : B2P, EXB, HSG, DUROSIL, PEWTER



**1351 : MILD STEEL GATE HANGER SQUARE POST BOTTOM**



**TECHNICAL DATA**

ITEM CODE	SIZE	LENGTH	WIDTH	THICKNESS	WT/ PCS	PCS. IN INNER	PCS. IN OUTER
MGR1351150	6"	214	197	6	1.810	4	16

FINISH AVAILABLE - B2P, EXB, HSG, DUROSIL



**1352 : MILD STEEL GATE HANGER SQUARE POST TOP**



**TECHNICAL DATA**

ITEM CODE	SIZE	LENGTH	WIDTH	THICKNESS	WT/ PCS	PCS. IN INNER	PCS. IN OUTER
MGR1352150	6"	214	197	6	1.845	4	16

FINISH AVAILABLE - B2P, EXB, HSG, DUROSIL



Available in High corrosion resistant finishes and most products also available in stainless steel